

SANDIA REPORT

SAND98-0071

Unlimited Release

Printed September 1998

Basic Data Report for Drillholes on the H-19 Hydropad (Waste Isolation Pilot Plant-WIPP)

Jerry W. Mercer, David L. Cole, Robert M. Holt

Prepared by
Sandia National Laboratories
Albuquerque, New Mexico 87185 and Livermore, California 94550

Sandia is a multiprogram laboratory operated by Sandia Corporation,
a Lockheed Martin Company, for the United States Department of
Energy under Contract DE-AC04-94AL85000.

Approved for public release; further dissemination unlimited.



Sandia National Laboratories

Issued by Sandia National Laboratories, operated for the United States Department of Energy by Sandia Corporation.

NOTICE: This report was prepared as an account of work sponsored by an agency of the United States Government. Neither the United States Government nor any agency thereof, nor any of their employees, nor any of their contractors, subcontractors, or their employees, makes any warranty, express or implied, or assumes any legal liability or responsibility for the accuracy, completeness, or usefulness of any information, apparatus, product, or process disclosed, or represents that its use would not infringe privately owned rights. Reference herein to any specific commercial product, process, or service by trade name, trademark, manufacturer, or otherwise, does not necessarily constitute or imply its endorsement, recommendation, or favoring by the United States Government, any agency thereof, or any of their contractors or subcontractors. The views and opinions expressed herein do not necessarily state or reflect those of the United States Government, any agency thereof, or any of their contractors.

Printed in the United States of America. This report has been reproduced directly from the best available copy.

Available to DOE and DOE contractors from
Office of Scientific and Technical Information
P.O. Box 62
Oak Ridge, TN 37831

Prices available from (615) 576-8401, FTS 626-8401

Available to the public from
National Technical Information Service
U.S. Department of Commerce
5285 Port Royal Rd
Springfield, VA 22161

NTIS price codes
Printed copy: A13
Microfiche copy: A01



SAND98-0071
Unlimited Release
Printed September 1998

Basic Data Report for Drillholes on the H-19 Hydropad (Waste Isolation Pilot Plant—WIPP)

Jerry W. Mercer, David L. Cole, and Robert M. Holt

Sandia National Laboratories
Albuquerque, NM 87185

ABSTRACT

Seven holes were drilled and wells (H-19b0, H-19b2, H-19b3, H-19b4, H-19b5, H-19b6, and H-19b7) were constructed on the H-19 hydropad to conduct field activities in support of the Culebra Transport Program. These wells were drilled and completed on the Waste Isolation Pilot Plant (WIPP) site during February to September 1995. An eighth hole, H-19b1, was drilled but had to be abandoned before the target depth was reached because of adverse hole conditions.

The geologic units penetrated at the H-19 location include surficial deposits of Holocene age, rocks from the Dockum Group of Upper Triassic age, the Dewey Lake Redbeds, and Rustler Formation of the Permian age. The Rustler Formation has been further divided into five informal members which include the Forty-niner Member, Magenta Member, Tamarisk Member, Culebra Dolomite Member, and an unnamed lower member.

The Rustler Formation, particularly the Culebra Dolomite Member, is considered critical for hydrologic site characterization. The Culebra is the most transmissive saturated unit above the WIPP repository and, as such, is considered to be the most likely pathway for radionuclide transport to the accessible environment in the unlikely event the repository is breached. Seven cores from the Culebra were recovered during drilling activities at the H-19 hydropad and detailed descriptions of these cores were made. On the basis of geologic descriptions, four hydrostratigraphic units were identified in the Culebra cores and were correlated with the mapping units from the WIPP air intake shaft. The entire length of H-19b1 was cored and was described in detail.

During coring of H-19b1, moisture was encountered in the upper part of the Dewey Lake Redbeds. A 41-ft-thick section of this core was selected for detailed description to qualify the geologic conditions related to perched water in the upper Dewey Lake. In addition to cuttings and core, a suite of geophysical logs run on the drillholes was used to identify and correlate different lithologies among the seven wells.

ACKNOWLEDGMENTS

The authors would like to thank Allan Sattler for his assistance during this field program. The review comments of Les Hill were also appreciated.

CONTENTS

1. INTRODUCTION	1
1.1 Purpose of WIPP	1
1.2 Purpose of the Drillholes at the H-19 Hydropad	1
2. GEOLOGIC AND CONSTRUCTION DATA	5
2.1 Drillhole H-19b0	9
2.2 Drillhole H-19b1	13
2.3 Drillhole H-19b2	19
2.4 Drillhole H-19b3	23
2.5 Drillhole H-19b4	27
2.6 Drillhole H-19b5	31
2.7 Drillhole H-19b6	35
2.8 Drillhole H-19b7	39
3. DETAILED DESCRIPTION AND INTERPRETATION OF SELECTED CORE INTERVALS FROM THE H-19 HYDROPAD	45
3.1 Culebra Hydrogeology at the H-19 Hydropad.....	45
3.2 Geology of the Rustler Formation at the H-19 Hydropad	65
3.3 Perched Water Tables in the Dewey Lake Redbeds.....	71
3.4 Summary	73
4. REFERENCES	75
APPENDIX A: Field Operations Plan and Well-Siting Memos	A-1
APPENDIX B: Abridged Hole Histories	B-1
APPENDIX C: Well Survey Plat	C-1
APPENDIX D: Well Permits and Records	D-1
APPENDIX E: Archeological Clearance Report	E-1
APPENDIX F: List of Geophysical Logs Run	F-1

Figures

1-1.	Location of the WIPP site.....	2
1-2.	Stratigraphic units at the WIPP site.....	3
2-1.	Location of the H-19 hydropad with respect to other well locations.	6
2-2.	Relative surface locations of the hydrologic drillholes at the H-19 hydropad.	7
2-3.	As-built conditions of hydrologic drillhole H-19b0.....	12
2-4.	As-built conditions of hydrologic drillhole H-19b2.....	22
2-5.	As-built conditions of hydrologic drillhole H-19b3.....	26
2-6.	As-built conditions of hydrologic drillhole H-19b4.....	30
2-7.	As-built conditions of hydrologic drillhole H-19b5.....	34
2-8.	As-built conditions of hydrologic drillhole H-19b6.....	38
2-9.	As-built conditions of hydrologic drillhole H-19b7.....	43
3-1.	Legend for the Culebra core descriptions of H-19b0, b2, b3, b4, b5, b6, and b7.	46
3-2a.	Detailed geologic description of the Culebra interval from H-19b0.....	47
3-2b.	Detailed geologic description of the Culebra interval from H-19b0.....	48
3-2c.	Detailed geologic description of the Culebra interval from H-19b0.....	49
3-3a.	Detailed geologic description of the Culebra interval from H-19b2.....	50
3-3b.	Detailed geologic description of the Culebra interval from H-19b2.....	51
3-4a.	Detailed geologic description of the Culebra interval from H-19b3.....	52
3-4b.	Detailed geologic description of the Culebra interval from H-19b3.....	53
3-5a.	Detailed geologic description of the Culebra interval from H-19b4.....	54
3-5b.	Detailed geologic description of the Culebra interval from H-19b4.....	55
3-5c.	Detailed geologic description of the Culebra interval from H-19b4.....	56
3-6a.	Detailed geologic description of the Culebra interval from H-19b5.....	57
3-6b.	Detailed geologic description of the Culebra interval from H-19b5.....	58
3-7a.	Detailed geologic description of the Culebra interval from H-19b6.....	59
3-7b.	Detailed geologic description of the Culebra interval from H-19b6.....	60
3-8a.	Detailed geologic description of the Culebra interval from H-19b7.....	61
3-8b.	Detailed geologic description of the Culebra interval from H-19b7.....	62
3-9.	Rustler stratigraphy	66
3-10a.	Detailed geologic description of the upper Rustler interval from H-19b1.....	67
3-10b.	Detailed geologic description of the upper Rustler interval from H-19b1.....	68
3-10c.	Detailed geologic description of the upper Rustler interval from H-19b1.....	69

Tables

2-1.	Abridged History of Drillhole H-19b0	10
2-2.	Summary of Drilling and Well Completion Records of Hydrologic Drillhole H-19b0	11
2-3.	Stratigraphic Summary of Drillhole H-19b0	13
2-4.	Abridged History of Drillhole H-19b1	14
2-4.	Abridged History of Drillhole H-19b1 (continued).....	15
2-5.	Summary of Drilling and Well Completion Records of Hydrologic Drillhole H-19b1	18
2-6.	Stratigraphic Summary of Drillhole H-19b1	19
2-7.	Abridged History of Drillhole H-19b2	20
2-8.	Summary of Drilling and Well Completion Records of Hydrologic Drillhole H-19b2	21
2-9.	Stratigraphic Summary of Drillhole H-19b2	23
2-10.	Abridged History of Drillhole H-19b3	24
2-11.	Summary of Drilling and Well Completion Records of Hydrologic Drillhole H-19b3	25
2-12.	Stratigraphic Summary of Drillhole H-19b3	27
2-13.	Abridged History of Drillhole H-19b4	28
2-14.	Summary of Drilling and Well Completion Records of Hydrologic Drillhole H-19b4	29
2-15.	Stratigraphic Summary of Drillhole H-19b4	31
2-16.	Abridged History of Drillhole H-19b5	32
2-17.	Summary of Drilling and Well Completion Records of Hydrologic Drillhole H-19b5	33
2-18.	Stratigraphic Summary of Drillhole H-19b5	35
2-19.	Abridged history of Drillhole H-19b6.....	36
2-20.	Summary of Drilling and Well Completion Records of Hydrologic Drillhole H-19b6	37
2-21.	Stratigraphic summary of Drillhole H-19b6.....	39
2-22.	Abridged History of Drillhole H-19b7	40
2-23.	Summary of Drilling and Well Completion Records of Hydrologic Drillhole H-19b7	41
2-24.	Stratigraphic Summary of Drillhole H-19b7	42
3-1.	Thicknesses of Culebra Hydrostratigraphic Units in H-19 Cores	63

Page intentionally left blank.

1. INTRODUCTION

This report presents data collected during the drilling and construction of seven wells (H-19b0, H-19b2, H-19b3, H-19b4, H-19b5, H-19b6, and H-19b7) on the H-19 hydropad at the Waste Isolation Pilot Plant (WIPP) site. Information obtained from an eighth drillhole that had to be abandoned, H-19b1, is also presented. The activities described herein were conducted between February and September 1995. Basic geologic, drilling, and well-construction data are presented in Section 2. Detailed geologic descriptions of the core collected are presented with other geologic data in Section 3. Included in appendices are the Field Operations Plan, pertinent memoranda, abridged hole histories, the well survey plat, well permits and records, the archeological clearance report for the site, and a list of the geophysical logs run by the Water Resources Division of the U.S. Geological Survey. Following the format of other basic data reports for WIPP drillholes, selected sections of this report are by different authors.

1.1 Purpose of WIPP

The WIPP is a U.S. Department of Energy (DOE) research and development facility designed to demonstrate the safe disposal of transuranic wastes resulting from the defense programs of the United States. The WIPP site is in eastern Eddy County, about 25 miles east of Carlsbad, New Mexico (Figure 1-1). The WIPP repository is excavated at a depth of approximately 2150 ft in bedded halite of the Permian-age Salado Formation. At the WIPP site, the Salado Formation is approximately 2000 ft thick and is overlain by the Permian-age Rustler Formation, which is about 300 ft thick (Figure 1-2).

Sandia National Laboratories (SNL), as scientific advisor to the DOE, supports the WIPP project through site characterization, including continuing evaluation of the geologic and hydrologic processes that may affect the WIPP site now and in the future.

1.2 Purpose of the Drillholes at the H-19 Hydropad

The Rustler Formation, particularly the Culebra Dolomite Member, is considered critical for hydrologic site characterization. The Culebra is the most transmissive saturated unit above the WIPP repository and, as such, is considered to be the most likely pathway for radionuclide transport to the accessible environment in the unlikely event the repository is breached.

Evaluation of WIPP's compliance with 40 CFR 191B by the WIPP Performance Assessment Department at SNL relies on a model of radionuclide transport through the Culebra. Modeling of transport through the Culebra requires, first, a conceptual model of the mechanisms and processes that govern the transport and, second, quantitative estimates of the parameters required for numerical simulation of those processes. The Culebra Transport Program was developed to provide the data necessary to construct a model for Culebra transport.

Field tracer tests are one component of the Culebra Transport Program. Tracer tests provide data with which to evaluate different processes affecting transport and to quantify transport parameters. Interpretations of previous tracer tests at the WIPP site indicated that the Culebra behaved locally as a double-porosity medium in which advective flow occurs through fractures while diffusion of solutes from the fractures to the surrounding rock matrix acts to retard solute transport. The seven boreholes in this program were drilled and completed to provide a group of test wells in which to conduct tracer tests to enhance our knowledge of the

parameters needed for performance assessment calculations. Construction of this “suite” of test wells also provided site-specific geologic and geophysical data and core samples from the Culobra for laboratory analyses. Detailed hydraulic tests were also conducted. The drilling and well-construction activities reported herein were performed following the Field Operations Plan (FOP) by Saulnier and Beauheim (1995), reprinted in Appendix A. The governing Quality Assurance program is described in the Memorandum of Record documenting modifications to the FOP also reprinted in Appendix A.

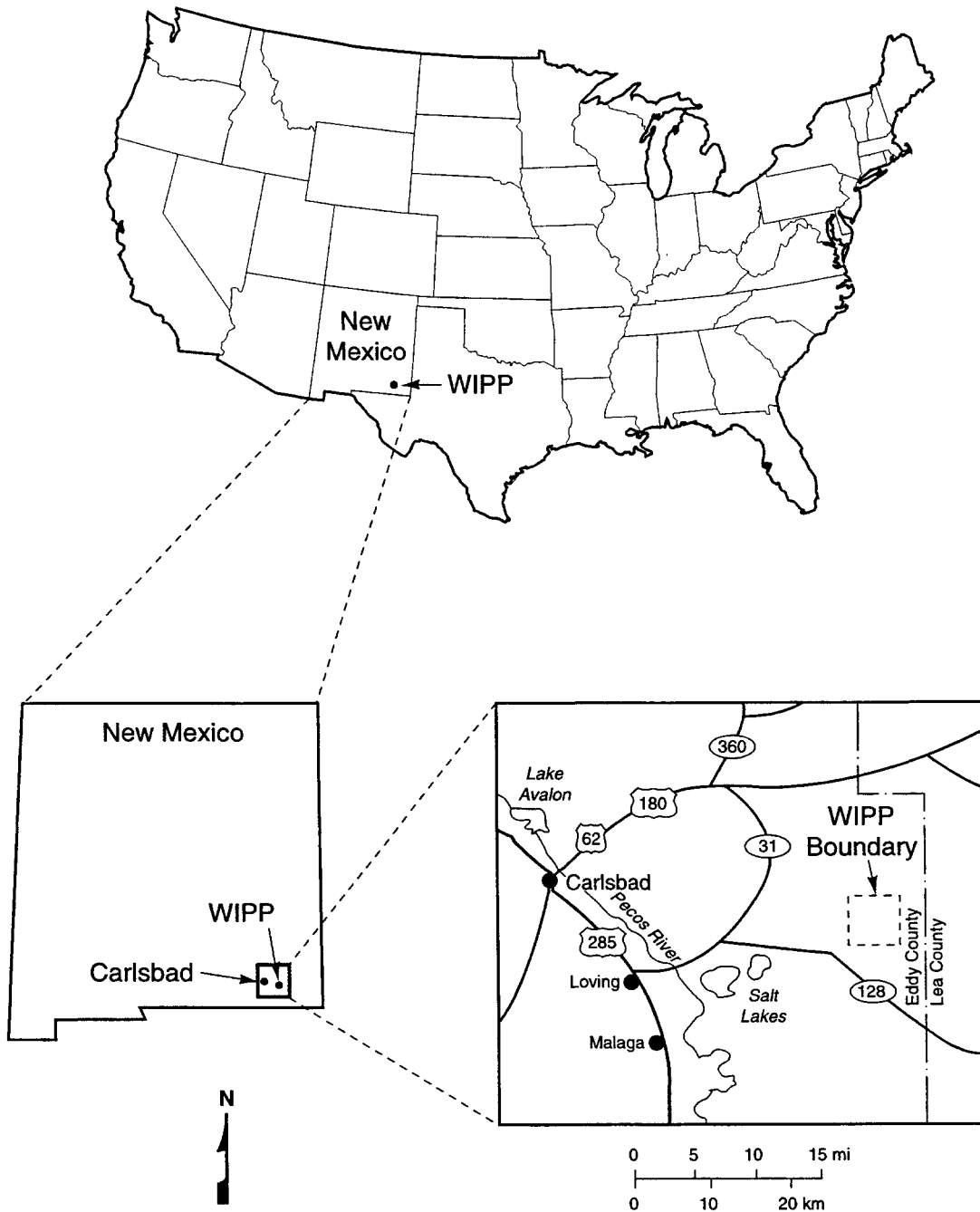

TRI-6330-3-5

Figure 1-1. Location of the WIPP site.

System	Series	Group	Formation	Member	Approximate Thickness* (m ft)		
Recent	Recent		Surficial Deposits		3	10	
Quaternary	Pleistocene		Mescalero Caliche		10	30	
			Gatuña				
Triassic		Dockum	Undivided		3	10	
Permian	Ochoan		Dewey Lake Redbeds		150	500	
			Rustler	Forty-niner		18	60
				Magenta		7	24
				Tamarisk		26	85
				Culebra Dolomite		7	24
				unnamed		37	120
			Salado		600	2000	
	Castile		400	1300			
	Guadalupian	Delaware Mountain	Bell Canyon		310	1000	
			Cherry Canyon		335	1100	
			Brushy Canyon		550	1800	

* At center of WIPP site.

TRI-6115-38-1

Figure 1-2. Stratigraphic units at the WIPP site.

Page intentionally left blank.

2. GEOLOGIC AND CONSTRUCTION DATA

The H-19 hydropad comprises seven test wells (H-19b0 through H-19b7), drilled to gather site-specific geologic and geophysical information and to provide a test pad on which to conduct hydraulic and tracer tests. These holes were drilled on a "hydropad" that is located southeast of the WIPP surface facilities between the H-3 hydropad and observation well DOE-1 (Figure 2-1). Originally to be the central well for the tracer test, H-19b1 had to be abandoned because of "stuck" tools lost during drilling and was replaced by H-19b0. The relative geographic positions of the seven wells at H-19 are shown in Figure 2-2. The target geologic unit that these tests were to investigate was the Culebra Dolomite Member of the Permian Rustler Formation.

Drilling and coring of these seven wells were accomplished from February 13 to September 6, 1995, on behalf of the U.S. Department of Energy (DOE). Technical direction and supervision of the drilling operations were provided by Sandia National Laboratories (SNL), Core support and core descriptions were provided by INTERA Inc. and by Robert M. Holt.

All measurements related to the H-19 drillholes are reported in inch-pound units. These units are used to facilitate the comparison of original measurements by surveyors to establish the geographic coordinates of the drillholes, by drillers reporting sample and core depths, and by geophysical loggers in recording inhole variations in rock properties versus depth. When metric equivalents of the inch-pound units are needed, use the following conversion factors.

To obtain metric unit	multiply English unit	by
meter (m)	foot (ft)	0.3048
millimeter (mm)	inch (in)	25.4
centimeter (cm)	inch (in)	2.54
kilometer (km)	mile (mi)	1.6093
kilogram (kg)	pound (lb)	0.454

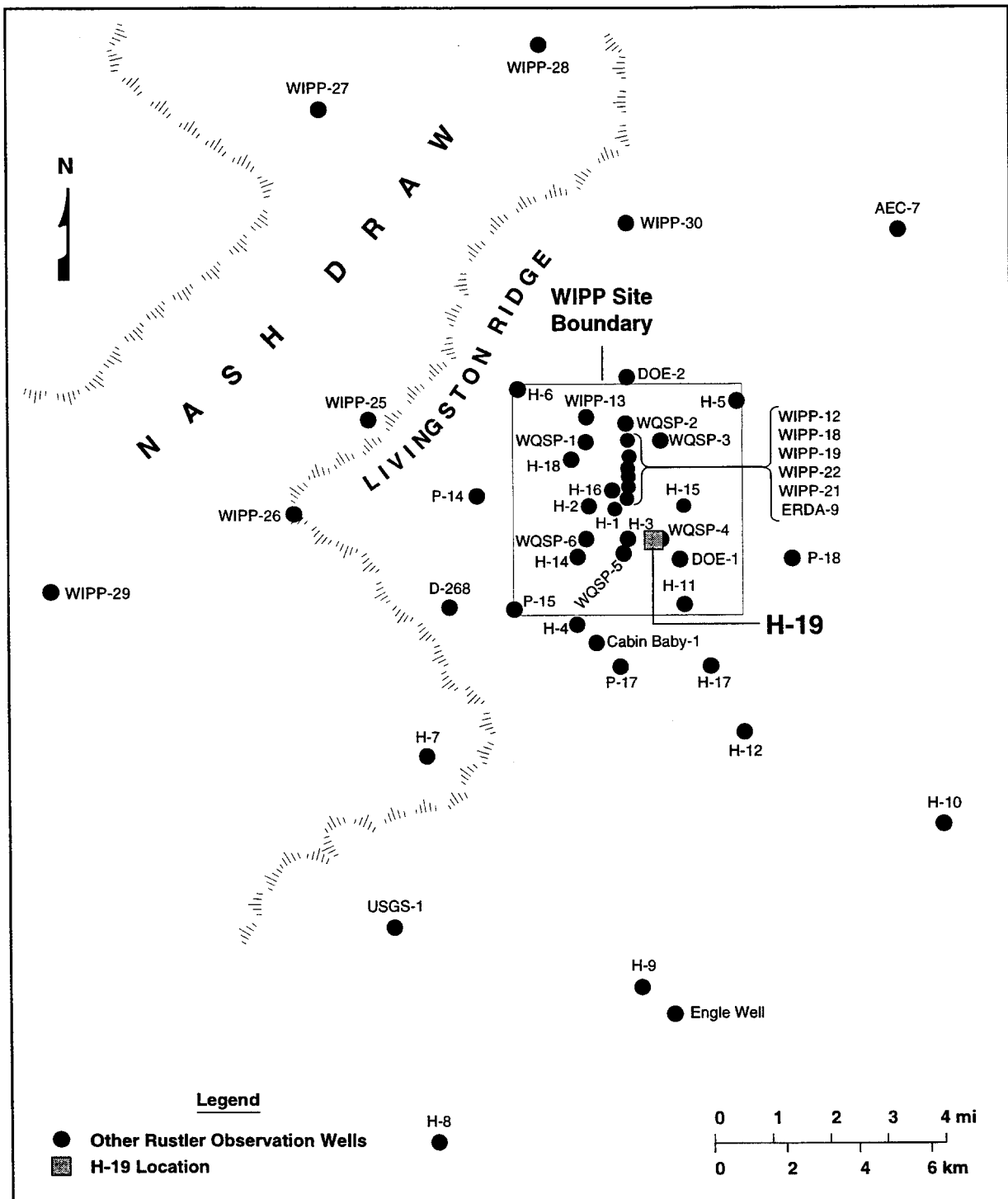

TRI-6344-665-6

Figure 2-1. Location of the H-19 hydropad with respect to other well locations.

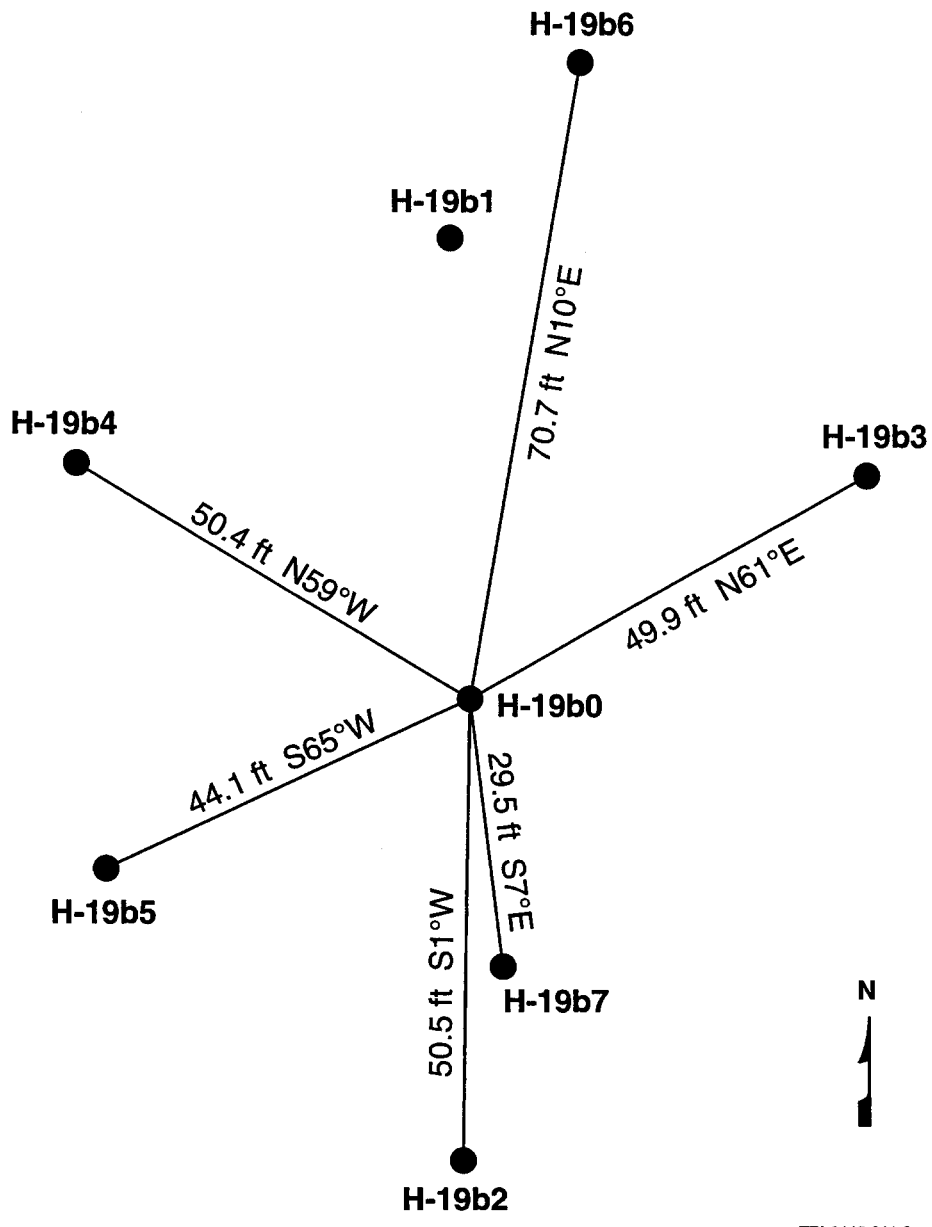

TRI-6115-911-0

Figure 2-2. Relative surface locations of the hydrologic drillholes at the H-19 hydrpad.

Conventional rotary-drilling procedures and saturated sodium chloride brine and salt gel were used to drill the upper part of all of the drillholes at the H-19 hydropad except H-19b1 from below the surface casing to a depth just above the target horizon. After a hole was cased, continuous wireline coring was conducted from below the casing to the total depth of the hole using either compressed air or a coring water pumped from the Culebra at either H-19b0 or a nearby well, WQSP-4. The interval cored in each of the H-19 drillholes except H-19b1 included the Culebra Dolomite Member of the Rustler Formation, which was the target geologic formation for the tracer testing. In H-19b1 continuous wireline coring was conducted from below the surface casing to the projected casing depth. Compressed air/mist was used to core all but the last 81 ft, which were cored with a saturated brine circulation fluid.

After completion of the well, a suite of geophysical logs was run by the Water Resources Division of the U.S. Geological Survey (USGS). The suite generally included (1) a natural gamma ray curve that records variations in the distribution of naturally occurring radioactive elements, (2) a neutron curve that records variations in the distribution of hydrogen, (3) a gamma-gamma density curve that records variations in rock density, and (4) a caliper log that measures the variations in the diameter of the drillhole. Appendix D lists the logs run in each hole.

The core was cleaned, measured, photographed, and described at the drill site by personnel from SNL, INTERA Inc., and DOE. (Section 3 of this report contains a detailed core description.) The core was then boxed and transported to the Core Library on the WIPP site, where it was signed over to Westinghouse personnel for recording and storage. Official photographs of the core were taken by SNL personnel.

Lithology and stratigraphy are discussed by geologic section. The geologic section in each of the drillholes at the H-19 hydropad included continental sediments of Quaternary and Triassic age and marine redbeds and evaporites of Late Permian age. The rock units are summarized for each drillhole in Tables 2-3, 2-6, 2-9, 2-12, 2-15, 2-18, 2-21, and 2-24.

Each drillhole, spudded in drill pad material (packed caliche), usually penetrated several ft of drill pad caliche, then several tens of ft of Holocene and Pleistocene deposits consisting of dune sand and Mescalero caliche. Below these deposits, the hole penetrated undifferentiated rocks of the Dockum Group of Late Triassic age.

Underlying the Triassic rocks, the Dewey Lake Redbeds consist of a thick sequence of dark-reddish-brown siltstone that contains sandstones and especially claystones interspersed at irregular intervals. The rock also contains grayish-green blebs and streaks resulting from the reduction of iron-bearing minerals. The lower two-thirds are distinguished by gypsum/anhydrite cement and gypsum-filled fractures, while the upper third is weakly cemented with carbonate and contains open fractures. These redbeds are the uppermost rocks of Late Permian age in the Delaware Basin.

The Rustler Formation underlies the Dewey Lake Redbeds and is divided into five members (from top to bottom): (1) Forty-niner Member; (2) Magenta Member; (3) Tamarisk Member; (4) Culebra Dolomite Member; and (5) an unnamed lower member. The Rustler Formation is also Late Permian in age.

The Forty-niner Member usually consists of two anhydrite or gypsum beds, or combinations of these separated by a claystone unit. Interpreting the lithology from cuttings, core from adjacent holes, and geophysical logs, the Forty-niner at the H-19 hydropad appears to be quite typical. The geophysical logs indicate that these units are predominantly anhydrite with some gypsum.

The Magenta Member, usually about 26 ft thick, underlies the Forty-niner Member. Again based on cuttings, core from adjacent holes, and geophysical logs, the lithology of the Magenta, a gypsiferous dolomite, is typical of other locations.

Underlying the Magenta is the Tamarisk Member. As identified in cuttings and core, the Tamarisk Member consists predominantly of upper and lower units of anhydrite and gypsum separated by relatively thin beds of siltstone and claystone.

The Culebra Dolomite Member, which underlies the Tamarisk Member, is usually about 24 ft thick. The Culebra commonly consists of clayey dolomite that is light-olive-gray to moderate-yellowish-brown in color. Numerous vugs, generally less than 1 mm in diameter, occur near the top and bottom of the member, but the central part of the member contains vugs as large as 5 mm. The rock is highly fractured in the central part, and only a few of the fractures are healed with gypsum (Section 3 contains a detailed lithologic description of the core).

Below the Culebra Dolomite Member is an unnamed lower member, which was penetrated only in its uppermost section. The part of this unit that was cored consists of black, plastic clay and reddish-brown clay containing selenite crystals and gypsum nodules, gypsum, and anhydrite.

2.1 Drillhole H-19b0

Drillhole H-19b0 is located in Eddy County, New Mexico; 1484.4 ft from the South line (FSL) and 2460.4 ft from the West line (FWL) of section 28, Township 22 South, Range 31 East, at a surface elevation of 3417.11 ft above mean sea level (AMSL). H-19b0 is a replacement hole for H-19b1 that was abandoned because of unrecoverable drill tools that were stuck in the hole. Figure 2-2 illustrates the location of drillhole H-19b0 in relation to the other drillholes on the H-19 hydropad. Table 2-1 includes the abridged hole history. Table 2-2 and Figure 2-3 show the well-completion records and the final “as-built” conditions of the H-19b0 well, respectively.

Conventional rotary drilling procedures and saturated sodium chloride brine and salt gel were used to drill the upper part of the drillhole from 38 ft (below the surface casing) to a depth of 735.5 ft (casing depth). After the hole was cased, continuous wireline coring was conducted from 740.8 ft to 778.7 ft (total depth of the hole) using water pumped from the Culebra at WQSP-4 as the circulation fluid. The interval cored in H-19b0 drillhole includes the Culebra Dolomite Member of the Rustler Formation, which was the target geologic formation for the tracer testing.

Table 2-3 summarizes the lithology and stratigraphy, including depth intervals, that were encountered in drillhole H-19b0.

Table 2-1. Abridged History of Drillhole H-19b0

LOCATION: Section 28, T. 22 S., R. 31 E. 1484.4 ft from South line and 2460.4 ft from West line

ALTITUDE: 3417.11 ft (AMSL). Datum for depth measurements in drilling and logging operations.

LOGS PREPARED BY: Robert M. Holt, New Mexico Tech; Jessie B. Dengate, INTERA Inc.

DRILLING CONTRACTOR: Water Development Corporation, Woodland, California

DRILLING RECORD:

Augered 24-inch hole to 38 ft, 40 ft of 20-inch OD surface pipe set.

Commenced drilling March 28, 1995.

Drilled 12.25-inch hole from 38 ft to 728 ft.

Reamed 12.25-inch hole to 14.75 inches to 735.5 ft.

Set and cemented 9.625-inch OD fiberglass casing to 731.9 ft.

Drilled out cement and shoe to 740.8 ft.

Cut 5.875-inch core from 740.8 ft to 778.7 ft.

Completed drilling operations April 23, 1995.

Core No.	Depth Interval (ft)		Interval (ft)		Recovered (%)
	from	to	cored	recovered	
1	740.8	– 745.8	5.0	5.0	100.0
2	745.8	– 750.8	5.0	5.0	100.0
3	750.8	– 755.8	5.0	5.0	100.0
4	755.8	– 760.8	5.0	4.6	92.0
5	760.8	– 765.2	4.4	3.6	82.0
6	765.2	– 770.2	5.0	0.0	0
7	770.2	– 773.7	3.5	4.4	126.0*
8	773.7	– 778.7	4.0	4.9	123.0*

* Excess core probably from previous run.

**Table 2-2. Summary of Drilling and Well Completion Records
of Hydrologic Drillhole H-19b0**

NOTE: All depths recorded are in ft below ground level.

WELL NAME: Hydrologic Drillhole H-19b0 (replacement hole for H-19b1)

LOCATION: Section 28, Township 22 South, Range 31 East

SURFACE COORDINATES: The well is located 1484.4 ft from the South line and 2460.4 ft from the West line of Section 28.

ELEVATION: All depths are reported below ground level (BGL) which is 3417.11 ft above mean sea level (AMSL). Primary datum for each well is a "v" notch in surface conductor casing that is 3417.49 ft AMSL.

DRILLING RECORD:

Start Date: Commenced drilling March 28, 1995; completed drilling activities April 23, 1995.

Circulation Fluid: Drilled with saturated sodium chloride brine water with salt gel to casing point at a depth of 735.5 ft. After casing was set, cemented, and drilled out the drilling fluid was changed over to Culebra water pumped from WQSP-4. Culebra water was used to core and ream the Culebra in H-19b0.

Cored Interval: 5.875-inch core was taken from 740.8 ft to 778.7 ft.

Rig and Drilling Contractor: Dresser T70W, Water Development Corporation, Woodland, California.

Drillhole Record:

Size (inches)	from (ft)	to (ft)
24	0	38
14.75	38	735.5
7.75	735.5	778.7 TD

Casing Record:

Size (inches)	Weight/foot (pounds)	from (ft)	to (ft)
20	53 (H-40 steel)	0	38
9.12	8.7 (Centron DHC-350) (Fiberglass)	0	731.9*

* 7.75-inch open hole from 735.5 ft to 778.7 ft.

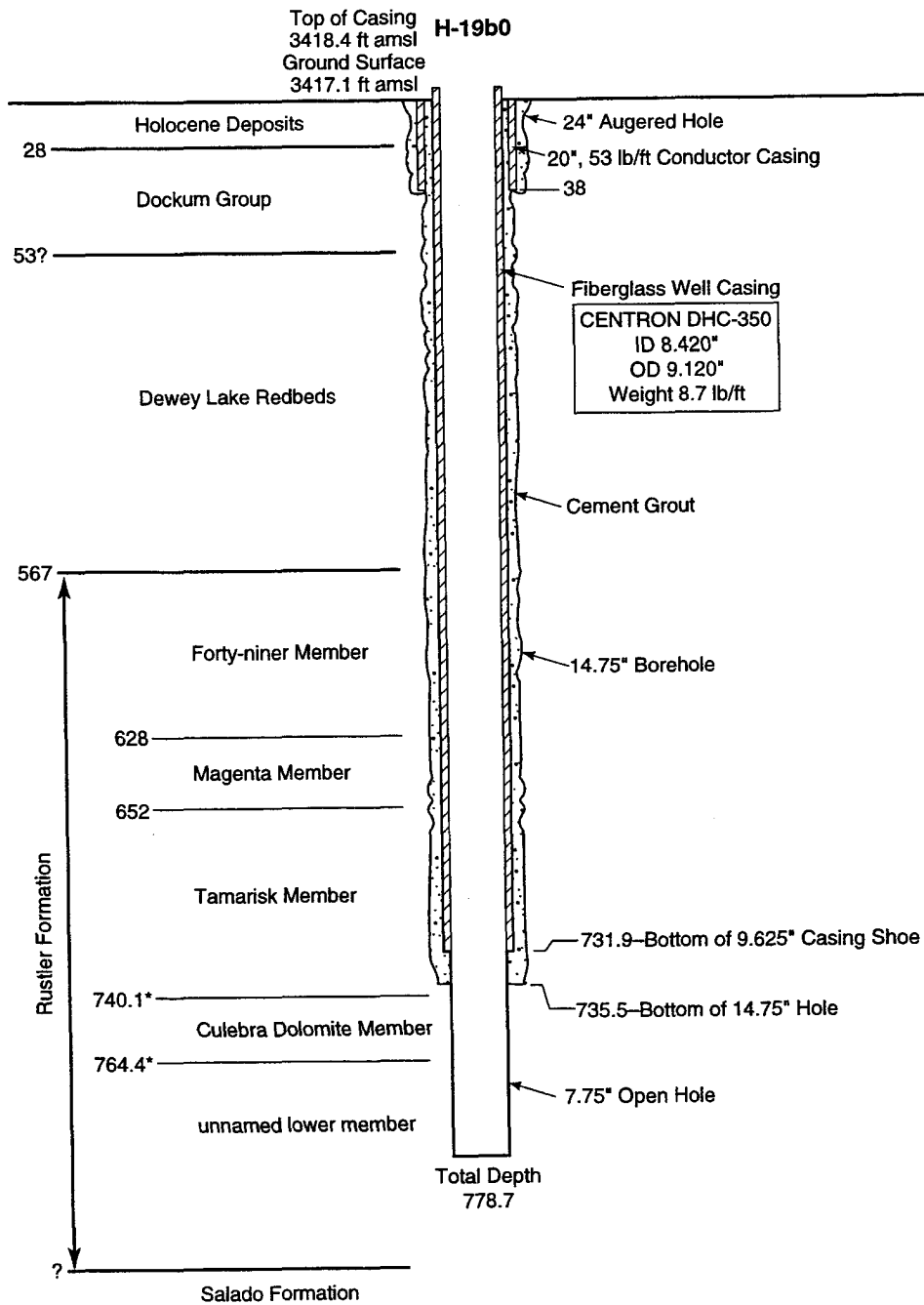

Notes:
 All depths are in approximate feet below ground surface.
 (*) indicates formation depths taken from core. All other formation depths from geophysical logs.
 (?) indicates uncertainty.
 Drawing not to scale.

TRI-6115-885-0

Figure 2-3. As-built conditions of hydrologic drillhole H-19b0.

Table 2-3. Stratigraphic Summary of Drillhole H-19b0

ROCK UNIT	DEPTH INTERVAL (ft)*
Quaternary Deposits	
Holocene Deposits**	0-28
Upper Triassic Rocks	
Dockum Group (undifferentiated)	28-53?
Upper Permian Rocks	
Dewey Lake Redbeds	53?-567
Rustler Formation	567-?
Forty-niner Member	567-628
Magenta Member	628-652
Tamarisk Member	652-740.1
Culebra Dolomite Member	740.1-764.4
unnamed lower member	764.4-?

* Depth intervals recorded from cuttings, cores, and geophysical logs.

** Includes dune sand and caliche.

2.2 Drillhole H-19b1

Drillhole H-19b1 is located in Eddy County, New Mexico, 1535.0 ft from the South line (FSL) and 2460.8 ft from the West line (FWL) of section 28, Township 22 South, Range 31 East, at a surface elevation of 3417.43 ft above mean sea level (AMSL). Drillhole H-19b1 was abandoned when drill tools were stuck in the hole. H-19b0 replaced H-19b1. Table 2-4 provides the abridged hole history of H-19b1 and Figure 2-3 shows the location of the abandoned drillhole in relation to the other holes drilled on the H-19 hydropad.

Continuous wireline coring was conducted from 38 ft (just below the surface casing) to a depth of 732.6 ft (projected casing depth). Compressed air/air mist was used to core from 38 ft to 651.6 ft; the coring fluid was changed to saturated brine from 651.6 ft to 732.6 ft. Following coring, the hole was reamed from 4.835 inches to 12.25 inches from 38 ft to 658 ft, where a tool joint broke and the drill tools became stuck in the hole. Numerous attempts at retrieving the tools were unsuccessful, and H-19b1 was abandoned. Subsequently, H-19b0 became the replacement hole.

A suite of geophysical logs (Appendix D) was run by the Water Resources Division of the U.S. Geological Survey after coring the hole. The lithology and stratigraphy, including depth intervals, that were encountered in drillhole H-19b1 are summarized in Table 2-5. Table 2-6 provides a stratigraphic summary of the drillhole. See Section 3.2 of this report for a detailed lithologic description of the core taken from H-19b1.

Table 2-4. Abridged History of Drillhole H-19b1

LOCATION: Section 28, T. 22 S., R. 31 E. 1535.0 ft from South line and 2460.8 ft from West line

ALTITUDE: 3417.43 ft (AMSL). Datum for depth measurements in drilling and logging operations.

LOGS PREPARED BY: Robert M. Holt, New Mexico Tech; Jessie B. Dengate, INTERA Inc.

DRILLING CONTRACTOR: Water Development Corporation, Woodland, California

DRILLING RECORD:

Augered 24-inch hole to 38 ft, 40 ft of 20-inch OD surface pipe set.

Commenced drilling February 14, 1995.

Cut 3.345-inch core by wireline method from 38 ft to 732.6 ft.

Reamed 4.835-inch hole to 12.25 inches from 38 ft to 658 ft.

Tool joint broke during reaming and lost tools from 573 ft to 658 ft.

Numerous attempts at tool retrieval were unsuccessful.

Hole abandoned March 19, 1995.

Core No.	Depth Interval (ft)			Interval (ft)		Recovered (%)
	from	–	to	cored	recovered	
1	36.8	–	41.8	5.0	5.0	100.0
2	41.8	–	46.8	5.0	5.0	100.0
3	46.8	–	51.8	5.0	5.0	100.0
4	51.8	–	56.8	5.0	4.9	98.0
5	56.8	–	61.6	4.8	4.8	100.0
6	61.6	–	66.6	5.0	4.3	86.0
7	66.6	–	71.6	5.0	4.9	98.0
8	71.6	–	76.6	5.0	5.0	100.0
9	76.6	–	81.6	5.0	5.0	100.0
10	81.6	–	86.6	5.0	4.9	98.0
11	86.6	–	91.6	5.0	5.0	100.0
12	91.6	–	96.6	5.0	5.0	100.0
13	96.6	–	101.6	5.0	5.0	100.0
14	101.6	–	106.6	5.0	4.5	90.0
15	106.6	–	111.6	5.0	4.8	96.0
16	111.6	–	116.6	5.0	5.0	100.0
17	116.6	–	121.6	5.0	4.5	90.0
18	121.6	–	126.6	5.0	4.9	98.0
19	126.6	–	131.6	5.0	5.0	100.0
20	131.6	–	136.6	5.0	5.0	100.0
21	136.6	–	141.6	5.0	5.0	100.0
22	141.6	–	146.6	5.0	4.9	98.0

Table 2-4. Abridged History of Drillhole H-19b1 (continued)

Core No.	Depth Interval (ft)			Interval (ft)		Recovered (%)
	from		to	cored	recovered	
23	146.6	-	151.6	5.0	5.0	100.0
24	151.6	-	156.6	5.0	4.9	98.0
25	156.6	-	161.6	5.0	5.0	100.0
26	161.6	-	164.0	2.4	2.4	100.0
27	164.0	-	169.0	5.0	4.8	96.0
28	169.0	-	174.0	5.0	5.0	100.0
29	174.0	-	179.0	5.0	5.0	100.0
30	179.0	-	184.0	5.0	2.2	44.0
31	184.0	-	188.0	4.0	2.7	68.0
32	188.0	-	193.0	5.0	4.0	80.0
33	193.0	-	198.0	5.0	4.4	88.0
34	198.0	-	203.0	5.0	5.0	100.0
35	203.0	-	208.0	5.0	5.0	100.0
36	208.0	-	213.0	5.0	5.0	100.0
37	213.0	-	218.0	5.0	5.0	100.0
38	218.0	-	223.0	5.0	5.0	100.0
39	223.0	-	228.0	5.0	5.0	100.0
40	228.0	-	233.0	5.0	5.0	100.0
41	233.0	-	238.0	5.0	5.0	100.0
42	238.0	-	243.0	5.0	5.0	100.0
43	243.0	-	248.0	5.0	5.0	100.0
44	248.0	-	253.0	5.0	4.9	98.0
45	253.0	-	258.0	5.0	5.0	100.0
46	258.0	-	263.0	5.0	5.0	100.0
47	263.0	-	268.0	5.0	5.0	100.0
48	268.0	-	273.0	5.0	5.0	100.0
49	273.0	-	278.0	5.0	5.0	100.0
50	278.0	-	283.0	5.0	5.0	100.0
51	283.0	-	288.0	5.0	5.0	100.0
52	288.0	-	293.0	5.0	5.0	100.0
53	293.0	-	298.0	5.0	5.0	100.0
54	298.0	-	303.0	5.0	5.0	100.0
55	303.0	-	308.0	5.0	5.0	100.0
56	308.0	-	313.0	5.0	5.0	100.0
57	313.0	-	318.0	5.0	5.0	100.0
58	318.0	-	323.0	5.0	5.0	100.0
59	323.0	-	328.0	5.0	5.0	100.0
60	328.0	-	333.0	5.0	5.0	100.0
61	333.0	-	338.0	5.0	5.0	100.0
62	338.0	-	343.0	5.0	5.0	100.0
63	343.0	-	348.0	5.0	5.0	100.0

Table 2-4. Abridged History of Drillhole H-19b1 (continued)

Core No.	Depth Interval (ft)		Interval (ft)		Recovered (%)	
	from	to	cored	recovered		
64	348.0	--	353.0	5.0	5.0	100.0
65	353.0	--	358.0	5.0	5.0	100.0
66	358.0	--	363.0	5.0	5.0	100.0
67	363.0	--	368.0	5.0	5.0	100.0
68	368.0	--	373.0	5.0	5.0	100.0
69	373.0	--	378.0	5.0	5.0	100.0
70	378.0	--	383.0	5.0	5.0	100.0
71	383.0	--	388.0	5.0	5.0	100.0
72	388.0	--	393.0	5.0	5.0	100.0
73	393.0	--	398.0	5.0	5.0	100.0
74	398.0	--	403.0	5.0	5.0	100.0
75	403.0	--	408.0	5.0	5.0	100.0
76	408.0	--	413.0	5.0	5.0	100.0
77	413.0	--	418.0	5.0	5.0	100.0
78	418.0	--	423.0	5.0	5.0	100.0
79	423.0	--	428.0	5.0	5.0	100.0
80	428.0	--	433.0	5.0	5.0	100.0
81	433.0	--	438.0	5.0	5.0	100.0
82	438.0	--	443.0	5.0	5.0	100.0
83	443.0	--	448.0	5.0	5.0	100.0
84	448.0	--	453.0	5.0	5.0	100.0
85	453.0	--	458.0	5.0	5.0	100.0
86	458.0	--	463.0	5.0	5.0	100.0
87	463.0	--	468.0	5.0	5.0	100.0
88	468.0	--	473.0	5.0	5.0	100.0
89	473.0	--	478.0	5.0	5.0	100.0
90	478.0	--	483.0	5.0	5.0	100.0
91	483.0	--	488.0	5.0	5.0	100.0
92	488.0	--	493.0	5.0	5.0	100.0
93	493.0	--	498.0	5.0	5.0	100.0
94	498.0	--	503.0	5.0	5.0	100.0
95	503.0	--	508.0	5.0	5.0	100.0
96	508.0	--	513.0	5.0	5.0	100.0
97	513.0	--	518.0	5.0	5.0	100.0
98	518.0	--	523.0	5.0	5.0	100.0
99	523.0	--	528.0	5.0	5.0	100.0
100	528.0	--	533.0	5.0	5.0	100.0
101	533.0	--	538.0	5.0	5.0	100.0
102	538.0	--	543.0	5.0	5.0	100.0
103	543.0	--	548.0	5.0	5.0	100.0
104	548.0	--	553.0	5.0	5.0	100.0

Table 2-4. Abridged History of Drillhole H-19b1 (continued)

Core No.	Depth Interval (ft)		Interval (ft)		Recovered (%)	
	from	to	cored	recovered		
105	553.0	–	558.0	5.0	5.0	100.0
106	558.0	–	563.0	5.0	5.0	100.0
107	563.0	–	568.0	5.0	5.0	100.0
108	568.0	–	573.0	5.0	5.0	100.0
109	573.0	–	578.0	5.0	5.0	100.0
110	578.0	–	583.0	5.0	5.0	100.0
111	583.0	–	588.0	5.0	5.0	100.0
112	588.0	–	593.0	5.0	5.0	100.0
113	593.0	–	598.0	5.0	5.0	100.0
114	598.0	–	603.0	5.0	2.5	50.0
115	603.0	–	608.0	5.0	5.0	100.0
116	608.0	–	613.0	5.0	5.0	100.0
117	613.0	–	618.0	5.0	5.0	100.0
118	618.0	–	623.0	5.0	5.0	100.0
119	623.0	–	628.0	5.0	5.0	100.0
120	628.0	–	633.0	5.0	4.4	88.0
121	633.0	–	638.0	5.0	2.2	44.0
122	638.0	–	642.6	4.6	4.6	100.0
123	642.6	–	647.6	5.0	5.0	100.0
124	647.6	–	651.6	4.0	4.0	100.0
125	651.6	–	654.6	3.0	2.8	93.0
126	654.6	–	659.6	5.0	4.8	96.0
127	659.6	–	664.6	5.0	5.0	100.0
128	664.6	–	669.6	5.0	5.0	100.0
129	669.6	–	674.6	5.0	5.0	100.0
130	674.6	–	677.6	3.0	2.9	97.0
131	677.6	–	682.6	5.0	5.0	100.0
132	682.6	–	687.6	5.0	5.0	100.0
133	687.6	–	692.6	5.0	5.0	100.0
134	692.6	–	697.6	5.0	4.8	96.0
135	697.6	–	702.6	5.0	5.0	100.0
136	702.6	–	707.6	5.0	5.0	100.0
137	707.6	–	712.6	5.0	5.0	100.0
138	712.6	–	717.6	5.0	5.0	100.0
139	717.6	–	722.6	5.0	5.0	100.0
140	722.6	–	727.6	5.0	5.0	100.0
141	727.6	–	732.6	5.0	5.0	100.0

**Table 2-5. Summary of Drilling and Well Completion Records
of Hydrologic Drillhole H-19b1**

NOTE: All depths recorded are in ft below ground level.

WELL NAME: Hydrologic Drillhole H-19b1

LOCATION: Section 28, Township 22 South, Range 31 East

SURFACE COORDINATES: The well is located 1535.0 ft from the South Line and 2460.8 ft from the West Line of Section 28.

ELEVATION: All depths are reported below ground level (BGL) which is 3417.43 ft above mean sea level (AMSL). Primary datum for each well is a "v" notch in surface conductor casing which is 3417.78 ft AMSL.

DRILLING RECORD:

Start Date: Commenced drilling February 14, 1995; completed drilling activities March 19, 1995, when hole was abandoned because of "stuck" tools.

Circulation Fluid: Cored with compressed air/air-mist to 651.6 ft and then changed over to saturated brine and cored to 732.6 ft. Reamed core hole with saturated brine and salt gel to 658 ft when tool joint broke and tool string was lost. Fishing was unsuccessful, and the drillhole was abandoned at this point.

Cored Interval: 3.345-inch core was taken from 36.8 ft to 732.6 ft.

Rig and Drilling Contractor: Dresser T70W, Water Development Corporation, Woodland, California.

Drillhole Record:

Size (inches)	from (ft)	to (ft)
24	0	38
12.25	38	658
4.835	658	732.6 TD

Casing Record:

Size (inches)	Weight/foot (pounds)	from (ft)	to (ft)
20	53 (H-40 steel)	0	38*

* Hole was abandoned and plugged because tools stuck in the hole were not retrievable. Tools (bit, stabilizers, and collars) are located in the hole at depths from 573 ft to 658 ft.

Table 2-6. Stratigraphic Summary of Drillhole H-19b1

ROCK UNIT	DEPTH INTERVAL (ft)*
Quaternary Deposits	
Holocene Deposits**	0-28
Upper Triassic Rocks	
Dockum Group (undifferentiated)	28-53?
Upper Permian Rocks	
Dewey Lake Redbeds	53?-567
Rustler Formation	567-?
Forty-niner Member	567-626.3
Magenta Member	626.3-650.5
Tamarisk Member	650.5-732.6
Culebra Dolomite Member	?-?
unnamed lower member	?-?

* Depth intervals recorded from cuttings, cores, and geophysical logs.

** Includes dune sand and caliche.

2.3 Drillhole H-19b2

Drillhole H-19b2 is located in Eddy County, New Mexico, 1434.3 ft from the South line (FSL) and 2459.6 ft from the West line (FWL) of section 28, Township 22 South, Range 31 East, at a surface elevation of 3417.13 ft above mean sea level (AMSL). Table 2-7 includes the abridged hole history. Table 2-8 and Figure 2-4 summarize well-completion records and the final "as-built" conditions of the H-19b2 well. Figure 2-2 illustrates the location of H-19b2 in relation to the other drillholes on the H-19 hydropad.

Conventional rotary drilling procedures and saturated sodium chloride brine and salt gel were used to drill from below the surface casing (37 ft) to a depth of 734.0 ft (casing depth). After casing was set to 732.35 ft, cemented, and drilled out, the drilling fluid was changed to compressed air, and continuous wireline coring was conducted from 735.5 ft to 764.5 ft. This interval cored includes the Culebra Dolomite Member of the Rustler Formation. Following completion of coring, the core hole was reamed, and a "rat hole" was drilled to 785.4 ft (total depth of hole). To prevent the hole from collapsing in the unnamed lower member, a PVC liner was placed from 765.4 to 785.4 ft.

After the hole was completed, a suite of geophysical logs (Appendix D) was run by the Water Resources Division of the U.S. Geological Survey. The lithology and stratigraphy, including depth intervals encountered in drillhole H-19b2, are summarized in Table 2-8. Section 3 of this report provides a detailed description of the core.

Table 2-7. Abridged History of Drillhole H-19b2

LOCATION: Section 28, T. 22 S., R. 31 E. 1434.3 ft from South line and 2459.6 ft from West line

ALTITUDE: 3417.13 ft (AMSL). Datum for depth measurements in drilling and logging operations.

LOGS PREPARED BY: Robert M. Holt, New Mexico Tech; Carl Young, INTERA Inc.

DRILLING CONTRACTOR: Water Development Corporation, Woodland, California

DRILLING RECORD:

Augered 18-inch hole to 37 ft, 40 ft of 14-inch OD surface pipe set.

Commenced drilling May 10, 1995.

Drilled 12.25-inch hole from 37 ft to 734.0 ft.

Set 7-inch fiberglass casing to 732.35 ft and cemented in May 16, 1995.

Cut 3.345-inch core by wireline method from 735.5 ft to 764.5 ft.

Reamed 4.835-inch core hole to 5.875 inches from 735.5 ft to 764.5 ft.

Drilled "rat hole" from 764.5 ft to 785.4 ft.

Drilling completed May 20, 1995.

Placed 5.5-inch PVC liner from 765.4 ft to 785.4 ft August 27, 1995.

Core No.	Depth Interval (ft)		Interval (ft)		Recovered (%)
	from	to	cored	recovered	
1	735.5	740.5	5.0	4.8	96.0
2	740.5	745.5	5.0	5.0	100.0
3	745.5	750.5	5.0	5.0	100.0
4	750.5	755.5	5.0	4.5	90.0
5	755.5	760.5	5.0	0	0
6	760.5	764.5	4.0	1.3	33.0

**Table 2-8. Summary of Drilling and Well Completion Records
of Hydrologic Drillhole H-19b2**

NOTE: All depths recorded are in ft below ground level.

WELL NAME: Hydrologic Drillhole H-19b2

LOCATION: Sec 28, Township 22 South, Range 31 East

SURFACE COORDINATES: The well is located 1434.3 ft from the South line and 2459.6 ft from the West line of Section 28.

ELEVATION: All depths are reported below ground level (BGL) which is 3417.13 ft above mean sea level (AMSL). Primary datum for each well is a "v" notch in surface conductor casing which is 3417.36 ft AMSL.

DRILLING RECORD:

Start Date: Commenced drilling May 10, 1995; completed drilling activities May 20, 1995. The drillhole was reworked August 27-28, 1995, when a PVC liner was placed in the hole.

Circulation Fluid: Drilled with saturated sodium chloride brine water with salt gel to casing point at a depth of 734.0 ft. After casing was set, cemented, and drilled out the drilling fluid was changed over to compressed air. Air was used to core and ream the Culebra in H-19b2.

Cored Interval: 3.345-inch core was taken from 735.5 ft to 764.5 ft.

Rig and Drilling Contractor: Dresser T70W, Water Development Corporation, Woodland, California.

Drillhole Record:

Size (inches)	from (ft)	to (ft)
18	0	37
12.25	37	734.0
5.875	734.0	785.4 TD

Casing Record:

Size (inches)	Weight/foot (pounds)	from (ft)	to (ft)
14	42 (H-40 steel)	0	37
7	5.7 (Centron DHC-300) (Fiberglass)	0	732.35*
5.5	3.9 (PVC)	765.4	785.4

*5.875-inch open hole from 734 ft to 764 ft.

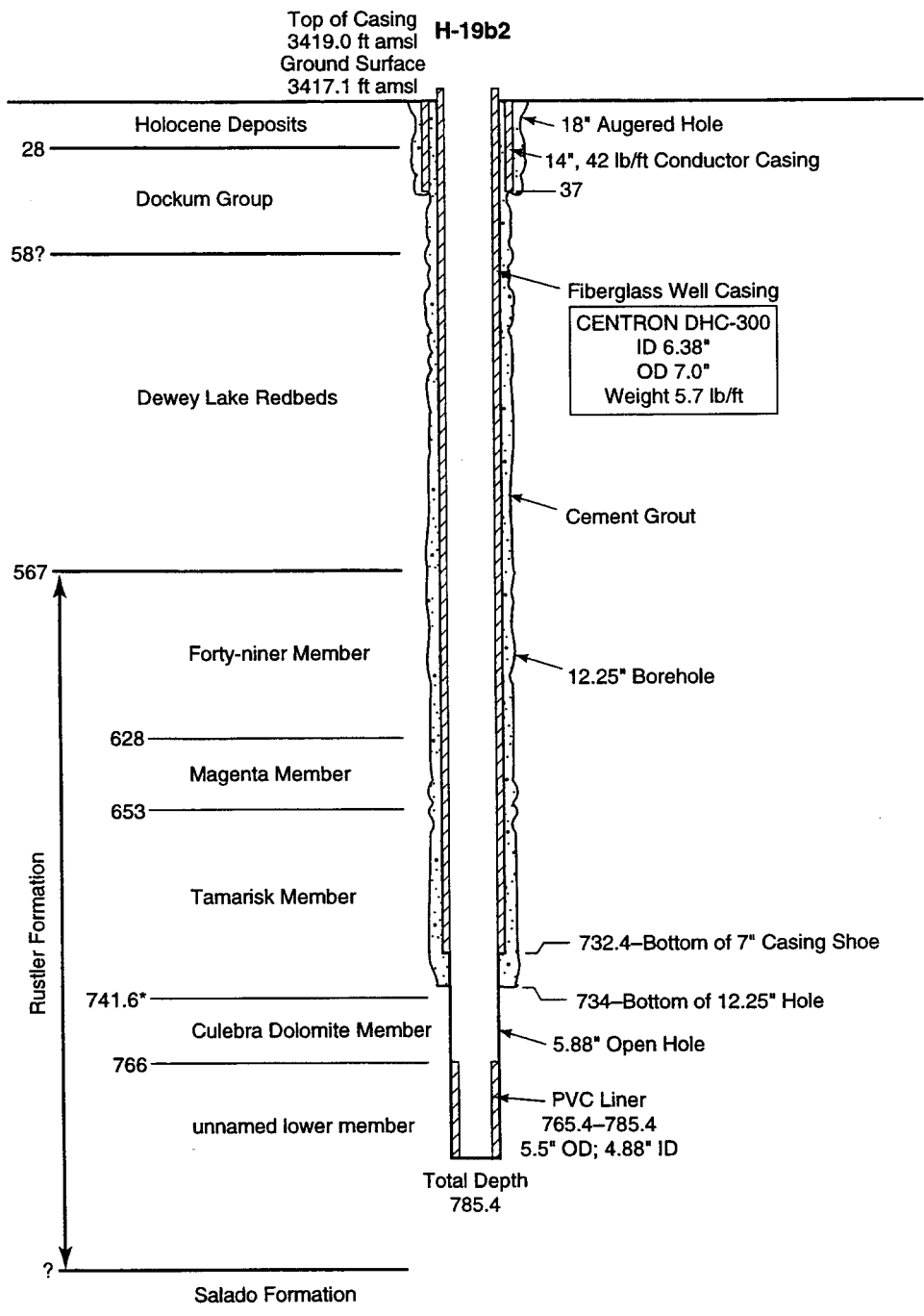

Notes:
 All depths are in approximate feet below ground surface.
 (*) indicates formation depths taken from core. All other formation depths from geophysical logs.
 (?) indicates uncertainty.
 Drawing not to scale.

TRI-6115-886-0

Figure 2-4. As-built conditions of hydrologic drillhole H-19b2.

Table 2-9. Stratigraphic Summary of Drillhole H-19b2

ROCK UNIT	DEPTH INTERVAL (ft)*
Quaternary Deposits	
Holocene Deposits**	0-28
Upper Triassic Rocks	
Dockum Group (undifferentiated)	28-58?
Upper Permian Rocks	
Dewey Lake Redbeds	58?-567
Rustler Formation	567-?
Forty-niner Member	567-628
Magenta Member	628-653
Tamarisk Member	653-741.6
Culebra Dolomite Member	741.6-766?
unnamed lower member	766?-?

* Depth intervals recorded from cuttings, cores, and geophysical logs.

** Includes dune sand and caliche.

2.4 Drillhole H-19b3

Drillhole H-19b3 is located in Eddy County, New Mexico, 1509.2 ft from the South line (FSL) and 2503.9 ft from the West line (FWL) of section 28, Township 22 South, Range 31 East, at a surface elevation of 3417.28 ft above mean sea level (AMSL). Table 2-10 provides the abridged hole history. Table 2-11 and Figure 2-5 present a summary of the well-completion records and the final "as-built" conditions of the H-19b3 well. Figure 2-2 illustrates the location of H-19b3 in relation to the other drillholes on the H-19 hydrograd.

Conventional rotary drilling procedures and saturated sodium chloride brine and salt gel were used to drill from 38 ft (just below the surface casing) to a depth of 734.0 ft (casing depth). After casing was set to 732.04 ft, cemented, and drilled out, the drilling fluid was changed to Culebra water pumped from H-19b0, and continuous wireline coring was conducted from 735.3 ft to 768.3 ft. This interval cored includes the tracer test target geologic horizon, the Culebra Dolomite Member of the Rustler Formation. Following completion of coring, the core hole was reamed and a "rat hole" was drilled to 784.9 ft (total depth). A PVC liner was placed from 763.2 to 783.2 ft to prevent the hole from collapsing in the unnamed lower member.

After completion of the hole, a suite of geophysical logs (Appendix D) was run by the Water Resources Division of the U.S. Geological Survey. The rock units, including depth intervals, are summarized in Table 2-12. A detailed description of the core is included in Section 3 of this report.

Table 2-10. Abridged History of Drillhole H-19b3

LOCATION: Section 28, T. 22 S., R. 31 E. 1509.2 ft from South line and 2503.9 ft from West line

ALTITUDE: 3417.28 ft (AMSL). Datum for depth measurements in drilling and logging operations.

LOGS PREPARED BY: Robert M. Holt, New Mexico Tech; Carl Young, INTERA Inc.

DRILLING CONTRACTOR: Water Development Corporation, Woodland, California

DRILLING RECORD:

Augered 18-inch hole to 38 ft, 40 ft of 14-inch OD surface pipe set.

Commenced drilling April 24, 1995.

Drilled 12.25-inch hole from 38 ft to 734.0 ft.

Set 7-inch fiberglass casing to 732.0 ft and cemented in April 30, 1995.

Cut 3.345-inch core by wireline method from 735.3 ft to 768.3 ft.

Reamed 4.835-inch core hole to 5.875 inches from 735.3 ft to 768.3 ft.

Drilled "rat hole" from 768.3 ft to 784.9 ft (total depth).

Drilling completed May 9, 1995.

Placed 5.5-inch PVC liner from 763.2 ft to 783.2 ft August 28, 1995.

Core No.	Depth Interval (ft)		Interval (ft)		Recovered (%)
	from	to	cored	recovered	
1	735.3	– 740.3	5.0	4.7	94.0
2	740.3	– 745.3	5.0	3.4	68.0
3	745.3	– 750.3	5.0	4.9	98.0
4	750.3	– 755.3	5.0	4.3	86.0
5	755.3	– 760.3	5.0	0	0
6	760.3	– 764.3	4.0	0	0
7	764.3	– 766.3	2.0	0	0
8	766.3	– 768.3	2.0	0	0

**Table 2-11. Summary of Drilling and Well Completion Records
of Hydrologic Drillhole H-19b3**

NOTE: All depths recorded are in ft below ground level.

WELL NAME: Hydrologic Drillhole H-19b3

LOCATION: Section 28, Township 22 South, Range 31 East

SURFACE COORDINATES: The well is located 1509.2 ft from the South line and 2503.9 ft from the West Line of Section 28.

ELEVATION: All depths are reported below ground level (BGL) which is 3417.28 ft above mean sea level (AMSL). Primary datum for each well is a "v" notch in surface conductor casing which is 3417.61 ft AMSL.

DRILLING RECORD:

Start Date: Commenced drilling April 24, 1995, and completed drilling activities May 9, 1995. The drillhole was reworked August 28–29, 1995, when a liner was placed in the hole.

Circulation Fluid: Drilled with saturated sodium chloride brine water with salt gel to casing point at a depth of 734.0 ft. After casing was set, cemented, and drilled out the drilling fluid was changed to Culebra water pumped from H-19b0. Culebra water was used to core and ream the Culebra in H-19b3.

Cored Interval: 3.345-inch core was taken from 735.3 ft to 768.3 ft.

Rig and Drilling Contractor: Dresser T70W, Water Development Corporation, Woodland, California.

Drillhole Record:

Size (inches)	from (ft)	to (ft)
18	0	38
12.25	38	734.0
5.875	734.0	784.9 TD

Casing Record:

Size (inches)	Weight/foot (pounds)	from (ft)	to (ft)
14	42 (H-40 steel)	0	38
7	5.7 (Centron DHC-300) (Fiberglass)	0	732.04*
5.5	3.9 (PVC)	763.2	783.2

*5.875-inch open hole from 734 ft to 762 ft

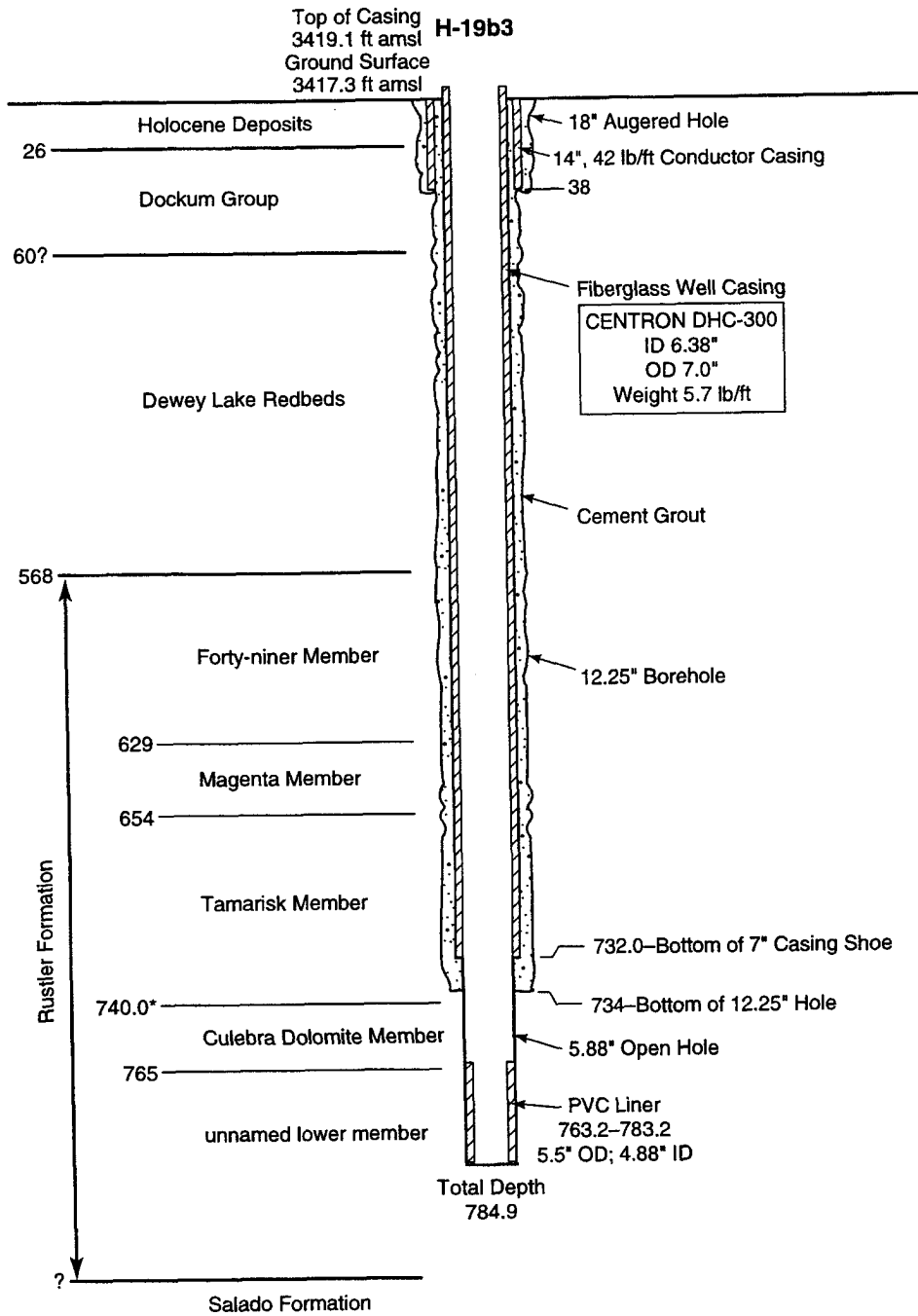

Notes:
 All depths are in approximate feet below ground surface.
 (*) indicates formation depths taken from core. All other formation depths from geophysical logs.
 (?) indicates uncertainty.
 Drawing not to scale.

TRI-6115-887-0

Figure 2-5. As-built conditions of hydrologic drillhole H-19b3.

Table 2-12. Stratigraphic Summary of Drillhole H-19b3

ROCK UNIT	DEPTH INTERVAL (ft)*
Quaternary Deposits	
Holocene Deposits**	0-26
Upper Triassic Rocks	
Dockum Group (undifferentiated)	26-60?
Upper Permian Rocks	
Dewey Lake Redbeds	60?-568
Rustler Formation	568-?
Forty-niner Member	568-629
Magenta Member	629-654
Tamarisk Member	654-740
Culebra Dolomite Member	740-765?
unnamed lower member	765?-?

* Depth intervals recorded from cuttings, cores, and geophysical logs.

** Includes dune sand and caliche.

2.5 Drillhole H-19b4

Drillhole H-19b4 is located in Eddy County, New Mexico, 1510.6 ft from the South line (FSL) and 2417.1 ft from the West line (FWL) of section 28, Township 22 South, Range 31. East, at a surface elevation of 3417.2 ft above mean sea level (AMSL). Table 2-13 presents the abridged hole history. Table 2-14 and Figure 2-6 give a summary of the well-completion records and the final "as-built" conditions of the H-19b4 well, respectively. Figure 2-2 shows the location of H-19b4 in relation to the other drillholes on the H-19 hydrograd.

Conventional rotary drilling procedures and saturated sodium chloride brine and salt gel were used to drill from 38 ft (just below the surface casing) to a depth of 734.0 ft (casing depth). After casing was set to 730.7 ft, cemented, and drilled out, the drilling fluid was changed to Culebra water pumped from H-19b0, and continuous wireline coring was conducted from 735.5 ft to 781.5 ft. This interval cored includes the tracer target geologic horizon (the Culebra Dolomite Member) and the upper part of the unnamed lower member of the Rustler Formation. Following completion of coring, the core hole was reamed to 781.5 ft (total depth). To prevent the hole from collapsing in the unnamed lower member, a PVC liner was placed from 761.8 to 781.0 ft.

After completion of the hole, a suite of geophysical logs (Appendix D) was run by the Water Resources Division of the U.S. Geological Survey. The lithology and stratigraphy, including depth intervals, are summarized in Table 2-15. Section 3 of this report contains a detailed core description of the lithology of the Culebra in drillhole H-19b4.

Table 2-13. Abridged History of Drillhole H-19b4

LOCATION: Section 28, T. 22 S., R. 31 E. 1510.6 ft from South line and 2417.1 ft from West line.

ALTITUDE: 3417.2 ft (AMSL). Datum for depth measurements in drilling and logging operations.

LOGS PREPARED BY: Robert M. Holt, New Mexico Tech; Carl Young, INTERA Inc.

DRILLING CONTRACTOR: Water Development Corporation, Woodland, California

DRILLING RECORD:

Augered 18-inch hole to 38 ft, 40 ft of 14-inch OD surface pipe set.

Commenced drilling May 20, 1995.

Drilled 12.25-inch hole from 38 ft to 734.0 ft.

Set 7-inch fiberglass casing to 730.7 ft and cemented in June 1, 1995.

Cut 3.345-inch core by wireline method from 735.5 ft to 781.5 ft.

Reamed 4.835-inch core hole to 5.875 inches from 735.5 ft to 781.5 ft.

Drilling completed June 5, 1995.

Placed 5.5-inch PVC liner from 761.8 ft to 781.0 ft August 21, 1995.

U.S. Geological Survey ran geophysical logs September 6, 1995.

Core No.	Depth Interval (ft)		Interval (ft)		Recovered (%)
	from	to	cored	recovered	
1	735.5	740.5	5.0	5.0	100.0
2	740.5	745.5	5.0	5.0	100.0
3	745.5	750.5	5.0	5.0	100.0
4	750.5	755.5	5.0	5.0	100.0
5	755.5	760.5	5.0	5.0	100.0
6	760.5	761.5	1.0	0.2	20.0
7	761.5	766.5	5.0	4.5	90.0
8	766.5	771.5	5.0	5.0	100.0
9	771.5	776.5	5.0	5.0	100.0
10	776.5	781.5	5.0	5.0	100.0

**Table 2-14. Summary of Drilling and Well Completion Records
of Hydrologic Drillhole H-19b4**

NOTE: All depths recorded are in ft below ground level.

WELL NAME: Hydrologic Drillhole H-19b4

LOCATION: Section 28, Township 22 South, Range 31 East

SURFACE COORDINATES: The well is located 1510.6 ft from the South line and 2417.1 ft from the West line of Section 28.

ELEVATION: All depths are reported below ground level (BGL) which is 3417.2 ft above mean sea level (AMSL). Primary datum was a "v" notch in the surface conductor casing which was inadvertently destroyed during the drilling operations. The reference point now is an aluminum cap near H-19b4 which is 3416.37 ft AMSL.

DRILLING RECORD:

Start Date: Commenced drilling May 20, 1995; completed drilling activities June 5, 1995. The drillhole was reworked August 21–22, 1995, when a PVC liner was placed in the hole.

Circulation Fluid: Drilled with saturated sodium chloride brine water with salt gel to casing point at a depth of 734.0 ft. After casing was set, cemented, and drilled out, the drilling fluid was changed to Culebra water pumped from H-19b0. Culebra water was used to core and ream the Culebra in H-19b4.

Cored Interval: 3.345-inch core was taken from 735.5 ft to 781.5 ft.

Rig and Drilling Contractor: Dresser T70W, Water Development Corporation, Woodland, California.

Drillhole Record:

Size (inches)	from (ft)	to (ft)
18	0	38
12.25	38	734.0
5.875	734.0	781.5 TD

Casing Record:

Size (inches)	Weight/foot (pounds)	from (ft)	to (ft)
14	42 (H-40 steel)	0	38
7	5.7 (Centron DHC-300) (Fiberglass)	0	730.7*
5.5	3.9 (PVC)	761.8	781.0

*5.875-inch open hole from 734.0 ft to 761 ft.

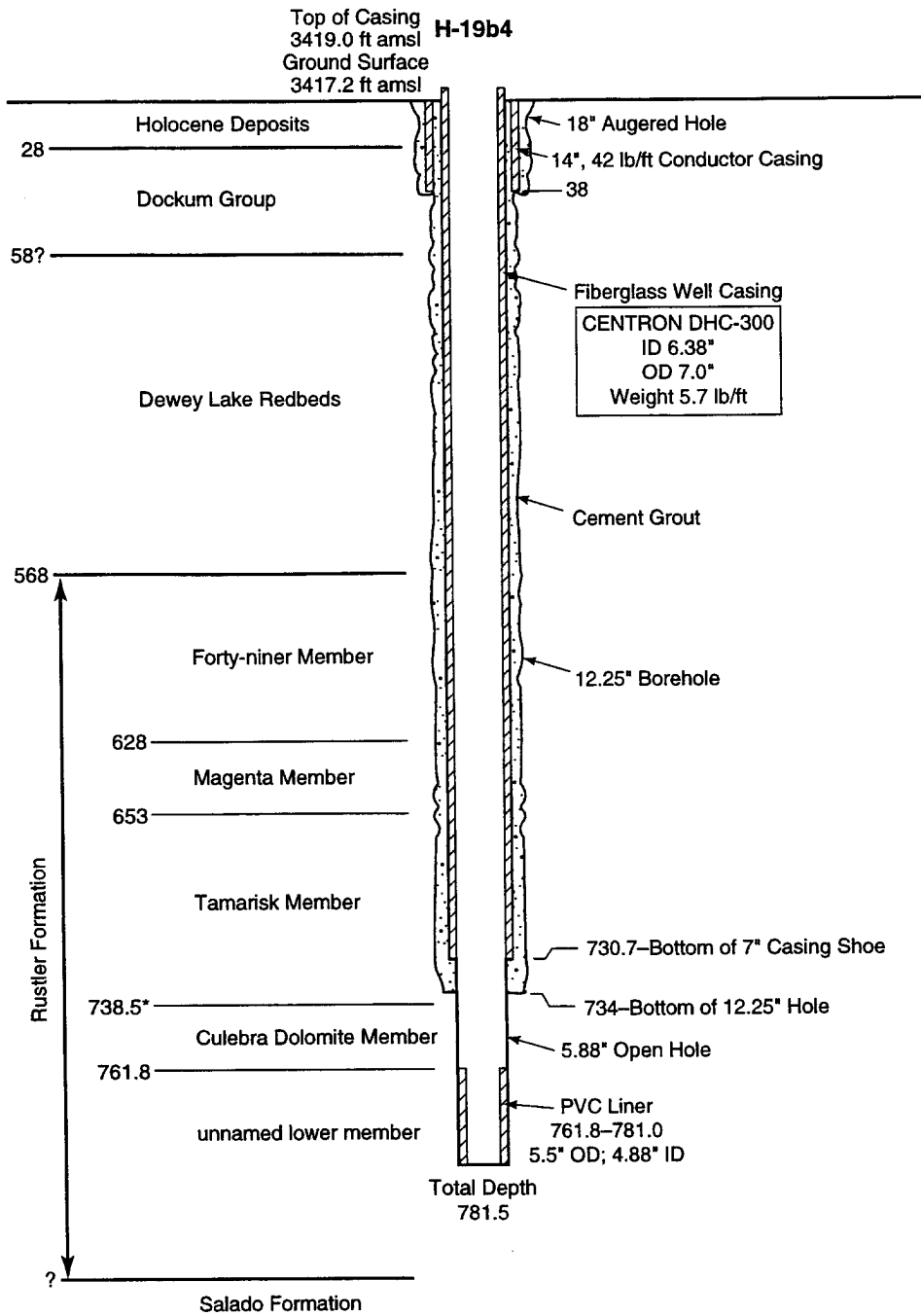

Notes:
 All depths are in approximate feet below ground surface.
 (*) indicates formation depths taken from core. All other formation depths from geophysical logs.
 (?) indicates uncertainty.
 Drawing not to scale.

TRI-6115-888-0

Figure 2-6. As-built conditions of hydrologic drillhole H-19b4.

Table 2-15. Stratigraphic Summary of Drillhole H-19b4

ROCK UNIT	DEPTH INTERVAL (ft)*
Quaternary Deposits	
Holocene Deposits**	0–28
Upper Triassic Rocks	
Dockum Group (undifferentiated)	28–58?
Upper Permian Rocks	
Dewey Lake Redbeds	58?–568
Rustler Formation	568–?
Forty-niner Member	568–628
Magenta Member	628–653
Tamarisk Member	653–738.5
Culebra Dolomite Member	738.5–761.8
unnamed lower member	761.8–?

* Depth intervals recorded from cuttings, cores, and geophysical logs.

** Includes dune sand and caliche.

2.6 Drillhole H-19b5

Drillhole H-19b5 is located in Eddy County, New Mexico, 1466.3 ft from the South line (FSL) and 2420.4 ft from the West line (FWL) of section 28, Township 22 South, Range 31 East, at a surface elevation of 3416.89 ft above mean sea level (AMSL). Table 2-16 shows the abridged hole history. Table 2-17 and Figure 2-7 summarize the well-completion records and illustrate the final “as-built” conditions of the H-19b5 well, respectively. Figure 2-2 shows the location of H-19b5 in relation to the other drillholes on the H-19 hydropad.

Conventional rotary drilling procedures and saturated sodium chloride brine and salt gel were used to drill from 37 ft (just below the surface casing) to a depth of 734.2 ft (casing depth). After casing was set to 730.7 ft, cemented, and drilled out, the drilling fluid was changed to compressed air, and air was used for continuous wireline coring from 735.5 ft to 785.5 ft. This interval cored includes the tracer target geologic horizon (the Culebra Dolomite Member) and the upper part of the unnamed lower member of the Rustler Formation. Following completion of coring, the core hole was reamed to 785.5 ft (total depth). To prevent the hole from collapsing in the unnamed lower member, a PVC liner was placed from 761.7 to 781.7 ft.

After completion of the hole, a suite of geophysical logs (Appendix D) by the Water Resources Division of the U.S. Geological Survey. The lithology and stratigraphy, including depth intervals, that were encountered in drillhole H-19b5 are summarized in Table 2-18. Section 3 of this report contains a detailed lithologic description of the core taken.

Table 2-16. Abridged History of Drillhole H-19b5

LOCATION: Section 28, T. 22 S., R. 31 E. 1466.3 ft from South line and 2420.4 ft from West line

ALTITUDE: 3416.89 ft (AMSL). Datum for depth measurements in drilling and logging operations.

LOGS PREPARED BY: Robert M. Holt, New Mexico Tech; Carl Young, INTERA Inc.

DRILLING CONTRACTOR: Water Development Corporation, Woodland, California

DRILLING RECORD:

Augered 18-inch hole to 37 ft, 40 ft of 14-inch OD surface pipe set.

Commenced drilling June 11, 1995.

Drilled 12.25-inch hole from 37 ft to 734.2 ft.

Set 7-inch fiberglass casing to 730.7 ft and cemented in June 29, 1995.

Moved rig off hole to H-19b6 July 9, 1995 before completing hole.

Moved rig back August 25, 1995

Cut 3.345-inch core by wireline method from 735.5 ft to 785.5 ft.

Reamed 4.835-inch core hole to 5.875 inches from 735.5 ft to 785.5 ft.

Drilling completed August 26, 1995.

Placed 5.5-inch PVC liner from 761.7 ft to 781.7 ft August 26, 1995.

U.S. Geological Survey ran geophysical logs September 6, 1995.

Core No.	Depth Interval (ft)		Interval (ft)		Recovered (%)
	from	to	cored	recovered	
1	735.5	– 740.5	5.0	4.6	92.0
2	740.5	– 745.5	5.0	5.0	100.0
3	745.5	– 750.5	5.0	4.2	84.0
4	750.5	– 755.5	5.0	3.0	60.0
5	755.5	– 760.5	5.0	4.5	90.0
6	760.5	– 765.5	5.0	4.1	82.0
7	765.5	– 770.5	5.0	5.0	100.0
8	770.5	– 775.5	5.0	4.8	96.0
9	775.5	– 780.5	5.0	5.0	100.0
10	780.5	– 785.5	5.0	3.5	70.0

**Table 2-17. Summary of Drilling and Well Completion Records
of Hydrologic Drillhole H-19b5**

NOTE: All depths recorded are in ft below ground level.

WELL NAME: Hydrologic Drillhole H-19b5

LOCATION: Section 28, Township 22 South, Range 31 East

SURFACE COORDINATES: The well is located 1466.3 ft from the South line and 2420.4 ft from the West line of Section 28.

ELEVATION: All depths are reported below ground level (BGL) which is 3416.89 ft above mean sea level (AMSL). Primary datum for each well is a "v" notch in surface conductor casing which is 3417.29 ft AMSL.

DRILLING RECORD:

Start Date: Commenced drilling June 11, 1995; completed initial drilling activities July 6, 1995. Following placement and cementing of casing at a depth of 730.7 ft, the rig was moved to another hole. The rig reoccupied the hole August 25, 1995, and the Culebra was cored, thus completing drilling activities. On August 26, 1995, the hole was reamed; a PVC liner was placed in the hole.

Circulation Fluid: Drilled with saturated sodium chloride brine water with salt gel to casing point at a depth of 734.2 ft. After casing was set, cemented, and drilled out, the drilling fluid was changed to compressed air. Air was used to core and ream the Culebra in H-19b5.

Cored Interval: 3.345-inch core was taken from 735.5 ft to 785.5 ft.

Rig and Drilling Contractor: Dresser T70W, Water Development Corporation, Woodland, California.

Drillhole Record:

Size (inches)	from (ft)	to (ft)
18	0	38
12.25	38	734.2
5.875	734.2	783.4
4.833	783.4	785.5 TD

Casing Record:

Size (inches)	Weight/foot (pounds)	from (ft)	to (ft)
14	42 (H-40 steel)	0	38
7	5.7 (Centron DHC-300) (Fiberglass)	0	730.7*
5.5	3.9 (PVC)	761.7	781.7

*5.875-inch open hole from 734.2 ft to 763 ft.

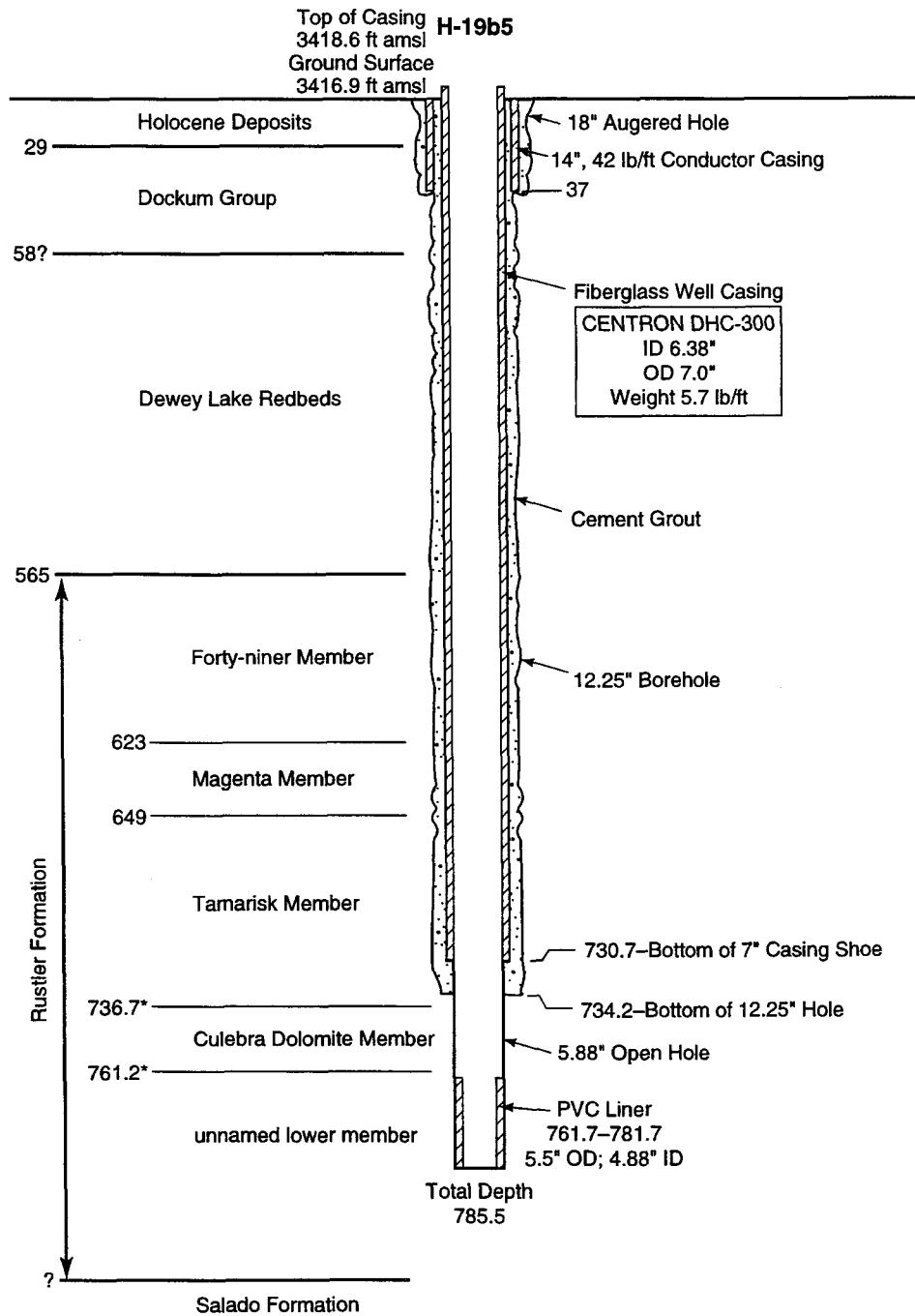

Notes:
 All depths are in approximate feet below ground surface.
 (*) indicates formation depths taken from core. All other formation depths from geophysical logs.
 (?) indicates uncertainty.
 Drawing not to scale.

TRI-6115-889-0

Figure 2-7. As-built conditions of hydrologic drillhole H-19b5.

Table 2-18. Stratigraphic Summary of Drillhole H-19b5

ROCK UNIT	DEPTH INTERVAL (ft)*
Quaternary Deposits	
Holocene Deposits**	0-29
Upper Triassic Rocks	
Dockum Group (undifferentiated)	29-58?
Upper Permian Rocks	
Dewey Lake Redbeds	58?-565
Rustler Formation	565-?
Forty-niner Member	565-623
Magenta Member	623-649
Tamarisk Member	649-736.7
Culebra Dolomite Member	736.7-761.2
unnamed lower member	761.2-?

* Depth intervals recorded from cuttings, cores, and geophysical logs.

** Includes dune sand and caliche.

2.7 Drillhole H-19b6

Drillhole H-19b6 is located in Eddy County, New Mexico, 1554.4 ft from the South line (FSL) and 2472.6 ft from the West line (FWL) of section 28, Township 22 South, Range 31 East, at a surface elevation of 3417.25 ft above mean sea level (AMSL). Table 2-19 presents the abridged hole history. Table 2-20 and Figure 2-8 summarize the well-completion records and show the final "as-built" conditions of the H-19b6 well. Figure 2-2 illustrates the location of drillhole H-19b6 in relation to the other drillholes on the H-19 hydropad.

Conventional rotary drilling procedures and saturated sodium chloride brine and salt gel were used to drill from 39 ft (just below the surface casing) to a depth of 732.8 ft (casing depth). After casing was set to 730.1 ft, cemented, and drilled out, the drilling fluid was changed to compressed air, and air was used for continuous wireline coring from 736.5 ft to 788.1 ft. This interval cored includes the tracer target geologic horizon (the Culebra Dolomite Member) and the upper part of the unnamed lower member of the Rustler Formation. Following completion of coring, the core hole was reamed to 788.1 ft (total depth). To prevent the hole from collapsing in the unnamed lower member, a PVC liner was placed from 765 to 785 ft.

After completion of the hole, a suite of geophysical logs (Appendix D) was run by the Water Resources Division of the U.S. Geological Survey. The rock units and their respective depth intervals are summarized in Table 2-21. Section 3 of this report contains a detailed description of these cored intervals.

Table 2-19. Abridged history of Drillhole H-19b6

LOCATION: Section 28, T. 22 S., R. 31 E. 1554.4 ft from South line and 2472.6 ft from West line

ALTITUDE: 3417.25 ft above mean sea level (AMSL). Datum for depth measurements in drilling and logging operations.

LOGS PREPARED BY: Robert M. Holt, New Mexico Tech; Carl Young, INTERA Inc.

DRILLING CONTRACTOR: Water Development Corporation, Woodland, California

DRILLING RECORD:

Augered 18-inch hole to 39 ft, 40 ft of 14-inch OD surface pipe set.

Commenced drilling July 10, 1995.

Drilled 12.25-inch hole from 39 ft to 732.8 ft.

Set 7-inch fiberglass casing to 730.1 ft and cemented in July 18, 1995.

Moved rig off hole to H-19b7 July 26, 1995 before completing hole.

Moved rig back August 22, 1995

Cut 3.345-inch core by wireline method from 736.5 ft to 788.1 ft.

Reamed 4.835-inch core hole to 5.875 inches from 736.5 ft to 788.1 ft.

Drilling completed August 24, 1995.

Placed 5.5-inch PVC liner from 765 ft to 785 ft August 24, 1995.

U.S. Geological Survey ran geophysical logs September 5, 1995.

Core No.	Depth Interval (ft)			Interval (ft)		Recovered (%)
	from		to	cored	recovered	
1	736.5	–	741.5	5.0	4.1	82.0
2	741.5	–	746.5	5.0	4.1	82.0
3	746.5	–	751.5	5.0	4.1	82.0
4	751.5	–	755.2	3.7	2.2	60.0
5	755.2	–	759.2	4.0	2.0	50.0
6	759.2	–	764.2	5.0	2.3	46.0
7	764.2	–	768.1	3.9	3.1	79.0
8	768.1	–	773.1	5.0	5.0	100.0
9	773.1	–	778.1	5.0	5.0	100.0
10	778.1	–	783.1	5.0	5.0	100.0
11	783.1	–	788.1	5.0	3.9	78.0

**Table 2-20. Summary of Drilling and Well Completion Records
of Hydrologic Drillhole H-19b6**

NOTE: All depths recorded are in ft below ground level.

WELL NAME: Hydrologic Drillhole H-19b6

LOCATION: Section 28, Township 22 South, Range 31 East

SURFACE COORDINATES: The well is located 1554.4 ft from the South line and 2472.6 ft from the West line of Section 28.

ELEVATION: All depths are reported below ground level (BGL) which is 3417.25 ft above mean sea level (AMSL). Primary datum for each well is a "v" notch in surface conductor casing which is 3417.50 ft AMSL.

DRILLING RECORD:

Start Date: Commenced drilling July 10, 1995; completed drilling activities July 26, 1995. Following placement and cementing of casing at a depth of 730.1 ft, the rig was moved to another hole. The rig reoccupied the H-19b6 hole August 23, 1995, and the Culebra was cored. On August 24, 1995, the hole was reamed, and a PVC liner was placed in the hole.

Circulation Fluid: Drilled with saturated sodium chloride brine water with salt gel to casing point at a depth of 732.8 ft. After casing was set, cemented, and drilled out, the drilling fluid was changed to compressed air. Air was used to core and ream the Culebra in H-19b6.

Cored Interval: 3.345-inch core was taken from 736.5 ft to 788.1 ft.

Rig and Drilling Contractor: Dresser T70W, Water Development Corporation, Woodland, California.

Drillhole Record:

Size (inches)	from (ft)	to (ft)
18	0	39
12.25	39	732.8
5.875	732.8	785.0
4.833	785.0	788.1 TD

Casing Record:

Size (inches)	Weight/foot (pounds)	from (ft)	to (ft)
14	42 (H-40 steel)	0	39
7	5.7 (Centron DHC-300) (Fiberglass)	0	730.1*
5.5	3.9 (PVC)	765	785

*5.875-inch open hole from 732.8 ft to 766 ft.

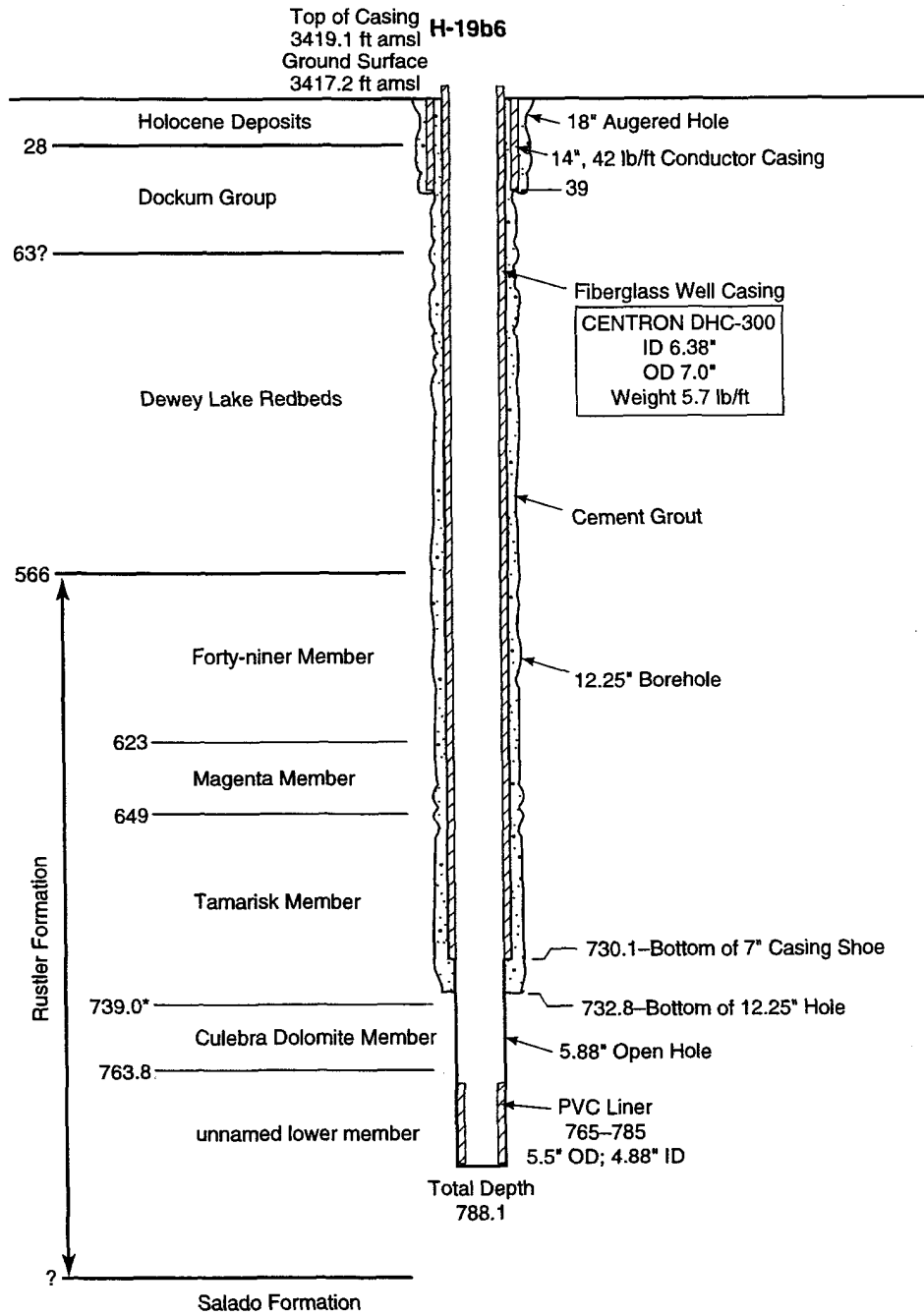

Notes:
 All depths are in approximate feet below ground surface.
 (*) indicates formation depths taken from core. All other formation depths from geophysical logs.
 (?) indicates uncertainty.
 Drawing not to scale.

TRI-6115-890-0

Figure 2-8. As-built conditions of hydrologic drillhole H-19b6.

Table 2-21. Stratigraphic summary of Drillhole H-19b6

ROCK UNIT	DEPTH INTERVAL (ft)*
Quaternary Deposits	
Holocene Deposits**	0-28
Upper Triassic Rocks	
Dockum Group (undifferentiated)	28-63?
Upper Permian Rocks	
Dewey Lake Redbeds	63?-566
Rustler Formation	566-623
Forty-niner Member	623-649
Magenta Member	649-649
Tamarisk Member	649-739
Culebra Dolomite Member	739.0-763.8
unnamed lower member	763.8-?

* Depth intervals recorded from cuttings, cores, and geophysical logs.

** Includes dune sand and caliche.

2.8 Drillhole H-19b7

Drillhole H-19b7 is located in Eddy County, New Mexico, 1455.6 ft from the South line (FSL) and 2464.1 ft from the West line (FWL) of section 28, Township 22 South, Range 31 East, at a surface elevation of 3416.94 ft above mean sea level (AMSL). Table 2-22 includes the abridged hole history. Tables 2-23 and 2-24 summarize the well-completion records and the rock units and their respective depth intervals, respectively. Figure 2-9 shows the final "as-built" conditions of the H-19b7 well. Figure 2-2 shows the location of H-19b7 in relation to the other drillholes on the H-19 hydropad.

Conventional rotary drilling procedures and saturated sodium chloride brine and salt gel were used to drill from 38 ft (just below the surface casing) to a depth of 678.6 ft. At 678.6 ft, continuous wireline coring was conducted in the Tamarisk Member of the Rustler Formation to a depth of 735.3 ft. After coring, the hole was reamed to a casing depth of 733.6 ft. Casing was set to 731.01 ft, cemented, and drilled out, then the drilling fluid was changed to compressed air. Air was used for continuous wireline coring from 736.0 ft to 783.0 ft. This interval cored includes the Culebra Dolomite Member and the upper part of the unnamed lower member of the Rustler Formation. Following completion of coring, the core hole was reamed to 783.0 ft and continued to 785.0 ft (total depth). To prevent the hole from collapsing in the unnamed lower member, a PVC liner was placed from 762.5 to 782.5 ft.

After completion of the hole, a suite of geophysical logs (Appendix D) was run by the Water Resources Division of the U.S. Geological Survey. Section 3 of this report contains a detailed core description.

Table 2-22. Abridged History of Drillhole H-19b7

LOCATION: Section 28, T. 22 S., R. 31 E. 1455.6 ft from South line and 2464.1 ft from West line

ALTITUDE: 3416.94 ft (AMSL). Datum for depth measurements in drilling and logging operations.

LOGS PREPARED BY: Robert M. Holt, New Mexico Tech; Carl Young, INTERA Inc.

DRILLING CONTRACTOR: Water Development Corporation, Woodland, California

DRILLING RECORD:

Augered 18-inch hole to 38 ft, 40 ft of 14-inch OD surface pipe set.

Commenced drilling July 27, 1995.

Drilled 6.25-inch hole from 38 ft to 577.4 ft.

Changed to 4.875-inch bit and drilled from 577.4 ft to 678.6 ft.

Cut 3.345-inch core by wireline method from 678.6 ft to 735.3 ft.

Reamed hole to 12.25 inches from 39 ft to 733.6 ft (casing depth).

Set 7-inch fiberglass casing to 731.01 ft; cemented in August 7, 1995.

Cut 3.345-inch core by wireline method from 736.0 ft to 783.0 ft.

Reamed 4.835-inch core hole to 5.875 inches from 733.6 ft to 785.0 ft.

Drilling completed August 18, 1995.

Placed 5.5-inch PVC liner from 762.5 ft to 782.5 ft August 19, 1995.

U.S. Geological Survey ran geophysical logs September 5, 1995.

Core No.	Depth Interval (ft)			Interval (ft)		Recovered (%)
	from		to	cored	recovered	
1	678.6	–	683.6	5.0	5.0	100.0
2	683.6	–	688.6	5.0	5.0	100.0
3	688.6	–	693.6	5.0	5.0	100.0
4	693.6	–	698.6	5.0	5.0	100.0
5	698.6	–	703.6	5.0	5.0	100.0
6	703.6	–	708.6	5.0	5.0	100.0
7	708.6	–	712.1	3.5	3.5	100.0
8	712.1	–	715.3	3.2	3.2	100.0
9	715.3	–	720.3	5.0	5.0	100.0
10	720.3	–	725.3	5.0	5.0	100.0
11	725.3	–	730.3	5.0	5.0	100.0
12	730.3	–	735.3	5.0	4.8	96.0
13	736.0	–	741.0	5.0	4.6	92.0
14	741.0	–	746.0	5.0	4.9	98.0

Table 2-22. Abridged History of Drillhole H-19b7 (continued)

Core No.	Depth Interval (ft)		Interval (ft)		Recovered (%)
	from	to	cored	recovered	
15	746.0	– 750.2	4.2	2.6	62.0
16	750.2	– 754.7	4.5	3.0	67.0
17	754.7	– 759.7	5.0	4.3	86.0
18	759.7	– 764.7	5.0	2.7	54.0
19	764.7	– 768.0	3.3	1.7	52.0
20	768.0	– 773.0	5.0	4.0	80.0
21	773.0	– 778.0	5.0	5.0	100.0
22	778.0	– 783.0	5.0	5.0	100.0

Table 2-23. Summary of Drilling and Well Completion Records of Hydrologic Drillhole H-19b7

NOTE: All depths recorded are in ft below ground level.

WELL NAME: Hydrologic Drillhole H-19b7

LOCATION: Section 28, Township 22 South, Range 31 East

SURFACE COORDINATES: The well is located 1455.6 ft from the South line and 2464.1 ft from the West line of Section 28.

ELEVATION: All depths are reported below ground level (BGL) which is 3416.94 ft above mean sea level (AMSL). Primary datum for each well is a “v” notch in surface conductor casing which is 3417.27 ft AMSL.

DRILLING RECORD:

Start Date: Commenced drilling July 27, 1995; completed drilling activities August 18, 1995. On August 18–19, 1995, the hole was reamed and a PVC liner was placed in the hole.

Circulation Fluid: Drilled with saturated sodium chloride brine water with salt gel to casing point at a depth of 733.6 ft. Cored the interval from 678.6 ft to 735.3 ft using saturated brine water. After casing was set, cemented, and drilled out, the drilling fluid was changed to compressed air. Air was used to core and ream the Culebra in H-19b7.

Cored Interval: 3.345-inch core was taken from 678.6 ft to 735.3 ft and from 736.0 ft to 783.0 ft.

Rig and Drilling Contractor: Dresser T70W, Water Development Corporation, Woodland, California.

Drillhole Record:

Size (inches)	from (ft)	to (ft)
18	0	38
12.25	38	733.6
5.875	733.6	785.0 TD

Casing Record:

Size (inches)	Weight/foot (pounds)	from (ft)	to (ft)
14	42 (H-40 steel)	0	38
7	5.7 (Centron DHC-300) (Fiberglass)	0	731.0*
5.5	3.9 (PVC)	762.5	782.5

*5.875-inch open hole from 731.0 ft to 762.5 ft.

Table 2-24. Stratigraphic Summary of Drillhole H-19b7

ROCK UNIT	DEPTH INTERVAL (ft)*
Quaternary Deposits	
Holocene Deposits**	0-28
Upper Triassic Rocks	
Dockum Group (undifferentiated)	28-60?
Upper Permian Rocks	
Dewey Lake Redbeds	60?-567
Rustler Formation	567-?
Forty-niner Member	567-627
Magenta Member	627-652
Tamarisk Member	652-739.5
Culebra Dolomite Member	739.5-764?
unnamed lower member	764?-?

* Depth intervals recorded from cuttings, cores, and geophysical logs.

** Includes dune sand and caliche.

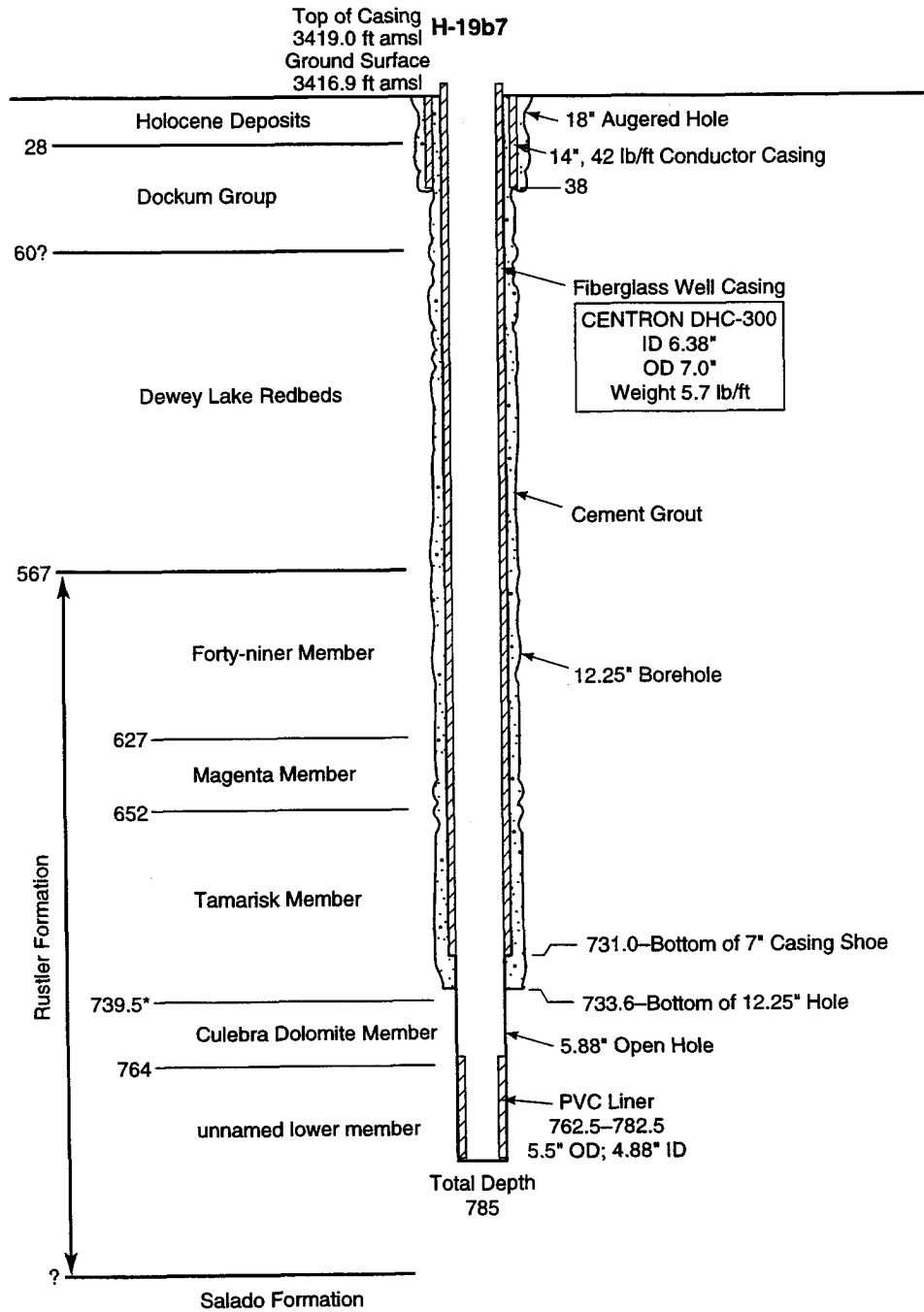

Notes:
 All depths are in approximate feet below ground surface.
 (*) indicates formation depths taken from core. All other formation depths from geophysical logs.
 (?) indicates uncertainty.
 Drawing not to scale.

TRI-6115-891-0

Figure 2-9. As-built conditions of hydrologic drillhole H-19b7.

Page intentionally left blank.

3. DETAILED DESCRIPTION AND INTERPRETATION OF SELECTED CORE INTERVALS FROM THE H-19 HYDROPAD

Robert M. Holt











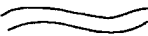

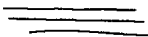



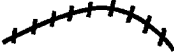

This section of the basic data report addresses special geologic issues related to the H-19 hydropad, including (1) geologic issues relevant to the hydraulic and tracer testing of the Culebra Dolomite Member of the Rustler Formation at the H-19 hydropad, (2) the general geologic characterization of the Rustler Formation; and (3) the origin of perched water in the upper part of the Dewey Lake Redbeds. During drilling activities at the H-19 hydropad, seven cores, H-19b0, H-19b2, H-19b3, H-19b4, H-19b5, H-19b6, and H-19b7, were removed from the Culebra and subsequently were described geologically in detail. The legend and the graphic logs from these descriptions are presented in Section 3.1. On the basis of the geologic descriptions, four hydrostratigraphic units were identified in the Culebra at the H-19 hydropad and are described in Section 3.1. In addition, the results reported here provided the basis for a conceptual model of transport processes in the Culebra (Holt, 1997).

In addition, the Dewey Lake Redbeds and the upper Rustler Formation were cored at another borehole, H-19b1. The entire Rustler section above the Culebra in the H-19b1 core was described in detail. The geologic description of the upper Rustler units is summarized and interpreted and a graphic log of the description is presented in Section 3.2. During the drilling of borehole H-19b1, moisture was encountered in the upper part of the Dewey Lake Redbeds. A 41-ft-thick section of the Dewey Lake was selected for detailed description to qualify the geologic conditions related to perched water in the upper Dewey Lake. These descriptions and related interpretations are presented in Section 3.3.

3.1 Culebra Hydrogeology at the H-19 Hydropad

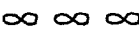
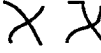
Seven Culebra cores were recovered during drilling activities at the H-19 hydropad and subsequently described. The legend used for the graphic logs of these descriptions is provided in Figure 3-1. The detailed descriptions of each core are provided in Figures 3-2 through 3-8. Observations of Culebra geologic features at the H-19 hydropad are consistent with the observations of Holt and Powers (1988; 1990a) and Beauheim and Holt (1990). Four hydrostratigraphic units were identified in the Culebra cores from the H-19 hydropad. These units correlate with the mapping units reported by Holt and Powers (1990a) from the Culebra at the WIPP air intake shaft (AIS). A summary of the thickness of each of these hydrostratigraphic units is presented in Table 3-1. The following discussion summarizes the geologic character of each of the hydrostratigraphic units at the H-19 hydropad and represents a synthesis of all H-19 hydropad core descriptions. Consistent with existing core and shaft descriptions and geophysical logs, English-System length units (ft, in) will be used.

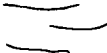
The uppermost hydrostratigraphic unit in the Culebra, CU-1, corresponds to AIS mapping units 1 and 2 and varies in thickness from 9.7 to 10.5 ft in complete cores from the H-19 hydropad (Table 3-1). CU-1 consists of well-indurated, microcrystalline dolomite. It is more massively bedded than the underlying units, and strata within the beds are primarily parallel. Some burrows are present, and bioturbation becomes less common upward. Several areally persistent zones showing cryptalgal layering occur within the upper part of CU-1, and H-19 cores show dark-brown-stained bedding-plane separations in the vicinity of these features.

Legend for H-19b0, b2, b3, b4, b5, b6, b7			
	Wavy strata		Coated grains
	Flat strata		Interbed containing poorly cemented silty dolomite
	Bedding plane parting with no cement filling		Vug filled with poikilotopic gypsum cement
	Cryptalgal layering		Vug
	Soft sediment deformation with shear		Gypsum-filled fracture
	Burrow or bioturbation		Gypsum nodule
	Microvugs		Halite or anhydrite pseudomorphs after vertically oriented prismatic gypsum crystals
	Breccia		Smeared Intraclast texture (e.g., Holt and Powers, 1988)
	Fractures with no cement or filling		Boudin structures
	Discontinuous or wispy strata		Irregular masses of poorly cemented silt- to clay-size dolomite

TRI-6801-41-1

Figure 3-1. Legend for the Culebra core descriptions of H-19b0, b2, b3, b4, b5, b6, and b7.

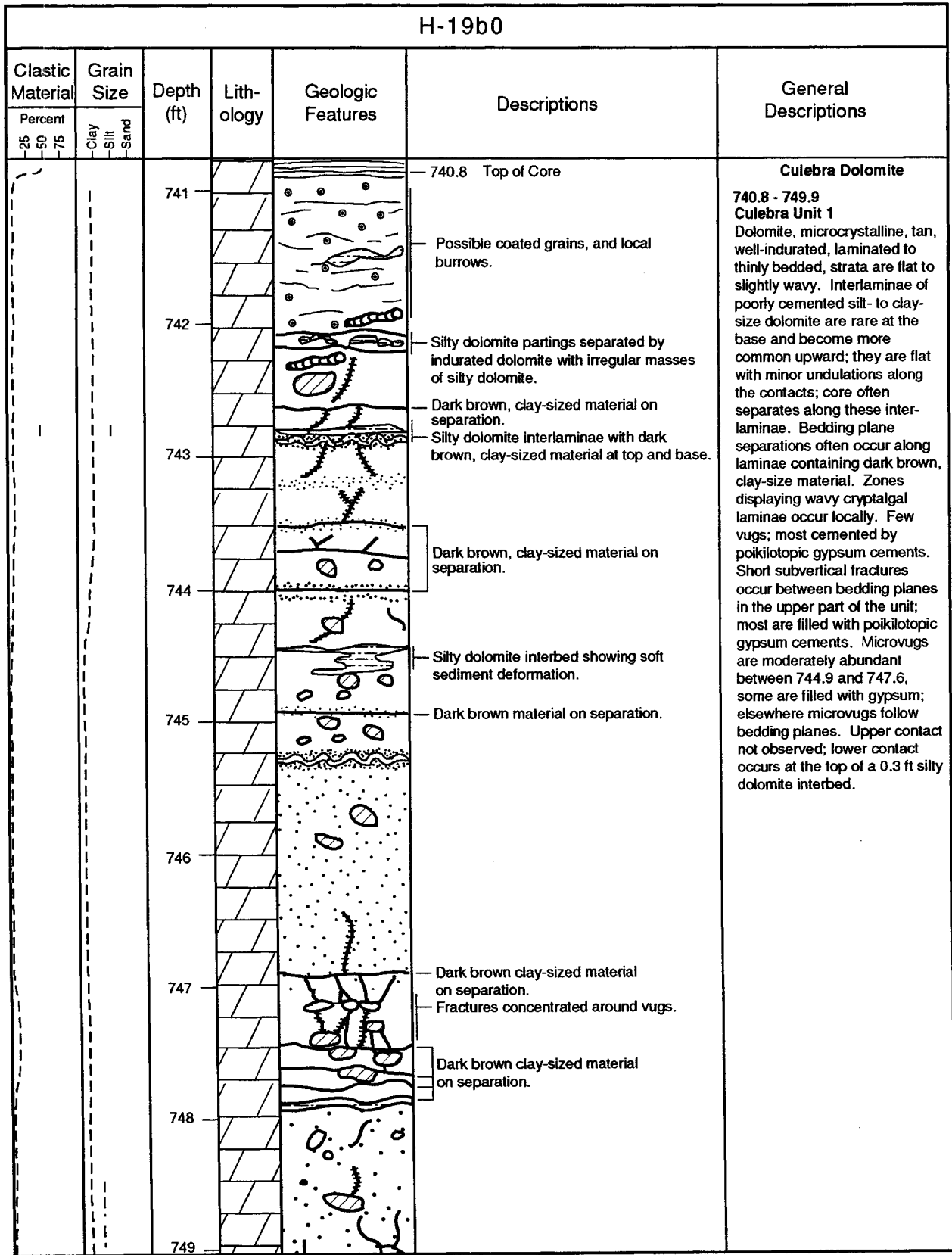
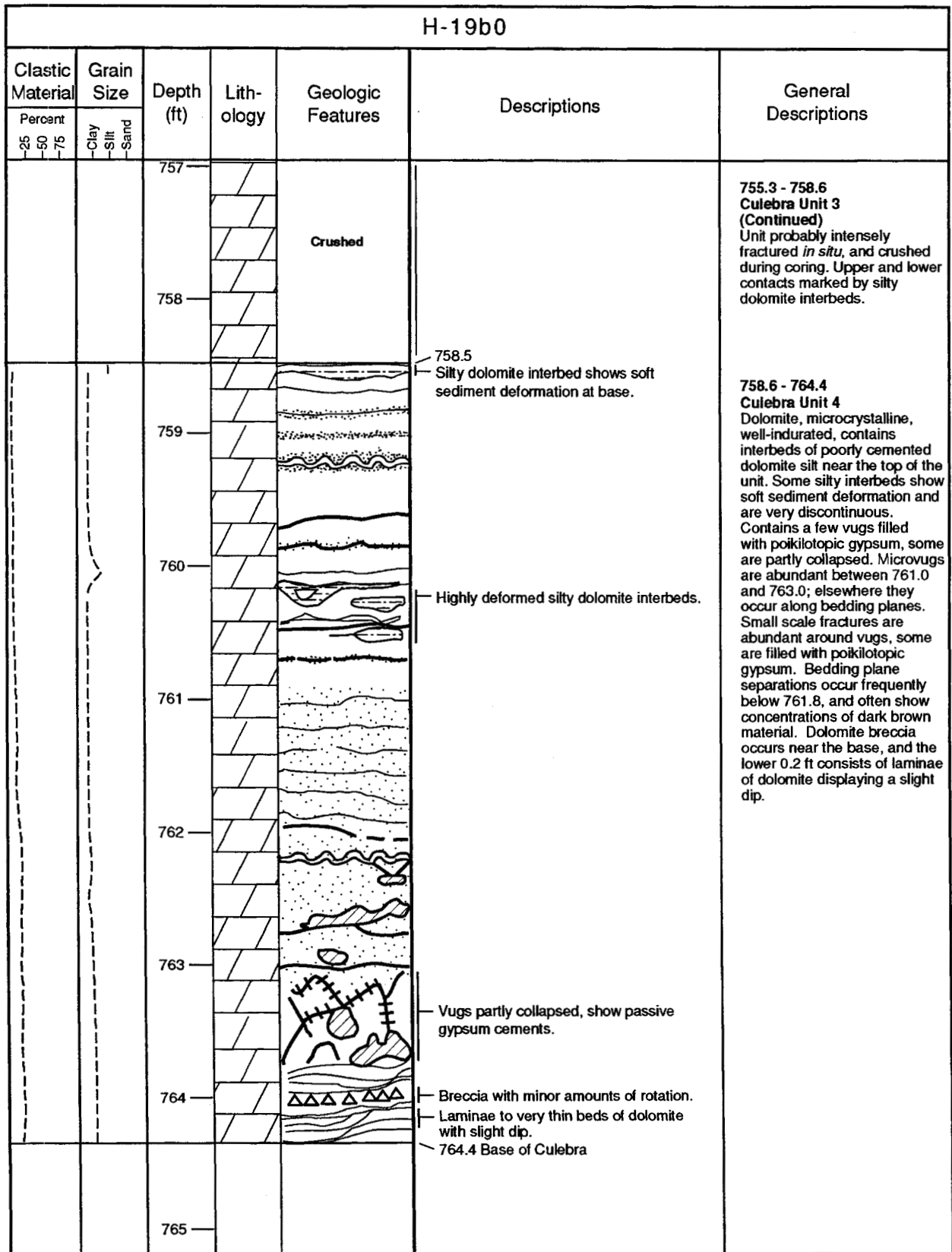

Figure 3-2a. Detailed geologic description of the Culebra interval from H-19b0.

H-19b0						
Clastic Material	Grain Size	Depth (ft)	Lithology	Geologic Features	Descriptions	General Descriptions
		750		Crushed	749.6 Crushed dolomite, dark brown stains of block surfaces. Some silt flour.	749.9 - 755.3 Culebra Unit 2 Well-indurated, microcrystalline dolomite with interlaminae and interbeds of poorly cemented, silt- to clay-size dolomite. Dolomite silt interbeds become more common upward; dolomite silt laminae show abundant soft sediment slumping and disruption near the base and in the middle of the unit. Locally shows bioturbation. Large vugs moderately abundant; some are filled with poikilotopic gypsum cements. Small-scale fractures with highly variable orientations occur around vugs, bedding planes, and dolomite silt interbeds. Intense fracturing below 754.0. Dark brown and orange stains are present on some fracture surfaces. Upper and lower contacts marked by silty dolomite interbeds.
		751			750.8 Microlaminated, silty dolomite interbed. Upper and lower surfaces show dark brown clay and minor soft sediment formation. Dark brown stains on some fracture surfaces.	
		752			Microlaminated, silty dolomite interbed. Upper and lower surfaces show dark brown clay and minor soft sediment formation.	
		753			Intensely fractured, some fracture surfaces show dark brown stains. Deformed interlaminae of siltstone.	
		754				
		755			Intensely fractured. Silty dolomite interlaminae deformed, have dark brown clay at top and bottom.	
		756		Crushed	755.8 Crushed dolomite, block size increases toward middle. Abundant silt flour. Dark brown stains on some block surfaces.	755.3 - 758.6 Culebra Unit 3 Zone almost entirely crushed and broken. Consists of irregular pieces of indurated dolomite and silty dolomite ranging from < 0.5 in. to over 5 in. on a side. Silt- to clay-sized dolomite flour abundant. Shows dark brown stains on some fracture surfaces.
		757				

TRI-6115-893-0

Figure 3-2b. Detailed geologic description of the Culebra interval from H-19b0.



TRI-6115-894-0

Figure 3-2c. Detailed geologic description of the Culebra interval from H-19b0.

H-19b2						
Clastic Material	Grain Size	Depth (ft)	Lithology	Geologic Features	Descriptions	General Descriptions
-25	-50	-75				
		741			741.6 Top of Culebra 741.7 741.9	<p>Culebra Dolomite</p> <p>741.6 - 751.3 Culebra Unit 1 Dolomite, microcrystalline, microlaminated to thinly bedded, strata are flat to wavy. Upper 1 ft consists of silty dolomite. Surface of core partly obscured by silty dolomite flour. Interlaminæ of silt- to clay-size dolomite are rare at the base and become more common upward. Bedding plane separations and surfaces of intact core show dark brown stains and accumulations of dark brown material. Orange stains occur along some fracture surfaces. Poikilotopic gypsum occurs in some fractures and post-dates orange and brown stains on fracture surfaces. Few vugs, microvugs are locally abundant and some are filled with poikilotopic gypsum. Small scale subvertical fractures are concentrated around bedding plane partings. Depth of lower contact of unit is estimated from core photographs.</p> <p>751.3 - 755.0 Culebra Unit 2 Crushed blocks of dolomite with irregular shapes; blocks range from < 0.5 to over 5 in. on a side. Intact dolomite is microcrystalline and microlaminated to thinly bedded. Silty dolomite flour is abundant. Surfaces of blocks may show orange and dark brown stains. Base of unit not observed.</p>
		742		Crushed	Shows cryptalgal layering and dark brown material. Silty, possible coated grains.	
		743		Crushed	Highly crushed, very silty, probable silty interbed.	
		744			Orange stain on subvertical fracture surfaces.	
		745		Crushed Dolomite	745.2	
		746		Crushed Dolomite	745.8 Some poikilotopic gypsum on fracture surfaces. 746.4	
		747		Crushed Dolomite	747.3	
		748		Crushed Dolomite	747.7 748.0 Core surface shows clay skin, penetrates 0.1 - 0.5 in.	
		749		Crushed Dolomite	748.9	
		750			749.5 Dark brown stains on fracture surfaces. Silty dolomite interbeds, spaced 0.2 - 0.5 ft.	
		751			751.2	
		752			Crushed blocks of dolomite; blocks typically very small, under 1 in. on a side. Surfaces of blocks show orange and dark brown stains. Silty dolomite abundant.	
		753		Crushed Dolomite		
		754				
		755			755.0	
		756		No Recovery		
		757				

TRI-6115-895-0

Figure 3-3a. Detailed geologic description of the Culebra interval from H-19b2.

H-19b2						
Clastic Material	Grain Size	Depth (ft)	Lithology	Geologic Features	Descriptions	General Descriptions
		757				
		758				
		759		No Recovery		
		760				
		761		Crushed Dolomite	760.5 761.8 Crushed blocks of dolomite are larger than above, usually >5 in. on a side. Block surfaces show dark brown stains. Abundant microvugs.	760.5 - 761.8 Culebra Unit 4 Upper and lower contacts of unit not observed. Consists of larger crushed blocks of well-indurated dolomite; blocks range from 1 to > 5 in. on a side. Some block surfaces show dark brown stains. Microvugs are abundant.
		762				
		763		No Recovery		
		764				
		765			764.5 Unnamed lower member. Gray mudstone, thin to micro-laminated. 765.0	
		766		No Recovery		
		767			766.7	



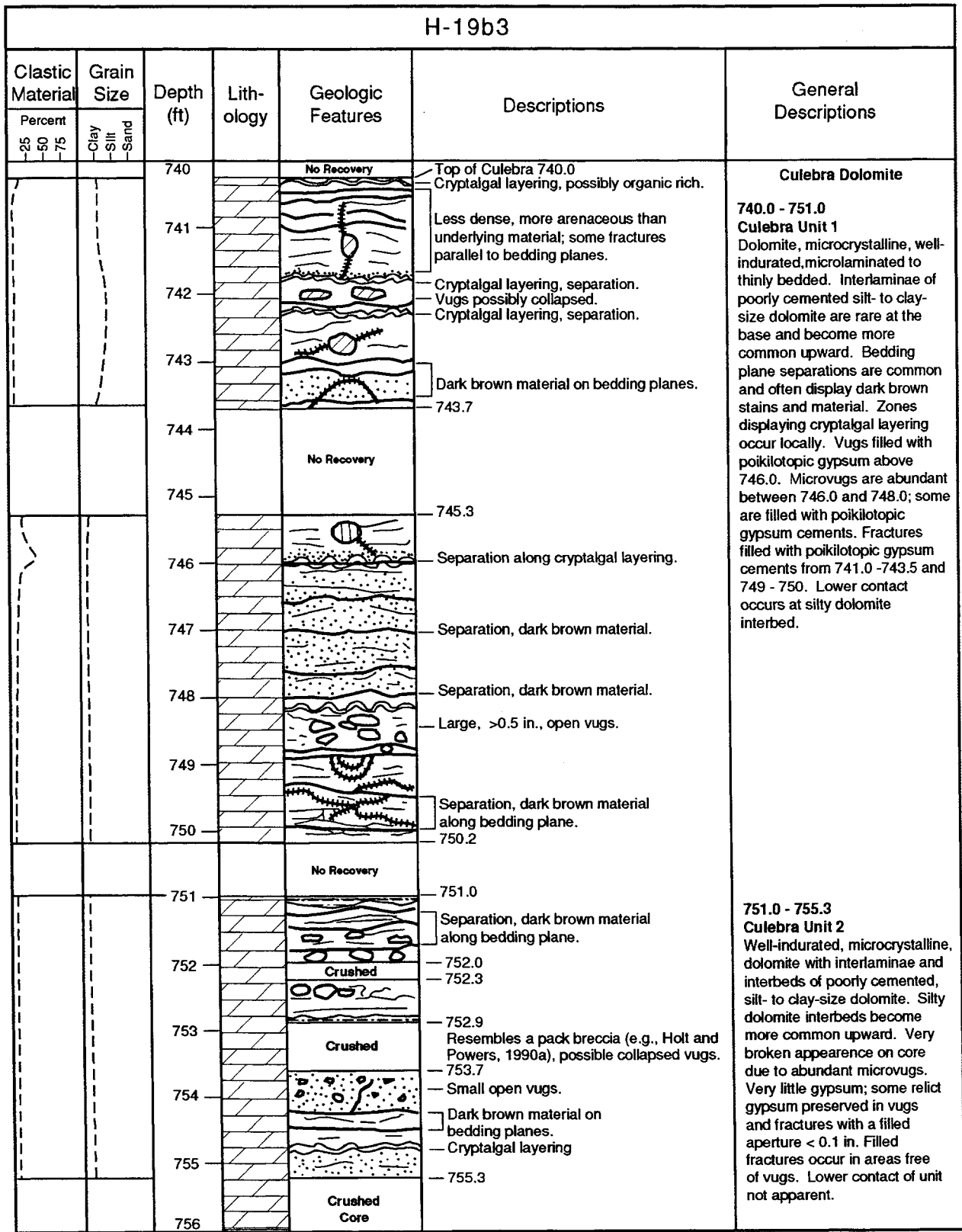

TRI-6115-998-0

Figure 3-3b. Detailed geologic description of the Culebra interval from H-19b2.



TRI-6115-897-0

Figure 3-4a. Detailed geologic description of the Culebra interval from H-19b3.

H-19b3						
Clastic Material	Grain Size	Depth (ft)	Lithology	Geologic Features	Descriptions	General Descriptions
25 50 75						
		756			Two pieces 4 inches long recovered, remainder lost.	
		757				
		758				
		759				
		760				
				No Further Recovery	760.3	

TRI-6115-898-0

Figure 3-4b. Detailed geologic description of the Culebra interval from H-19b3.

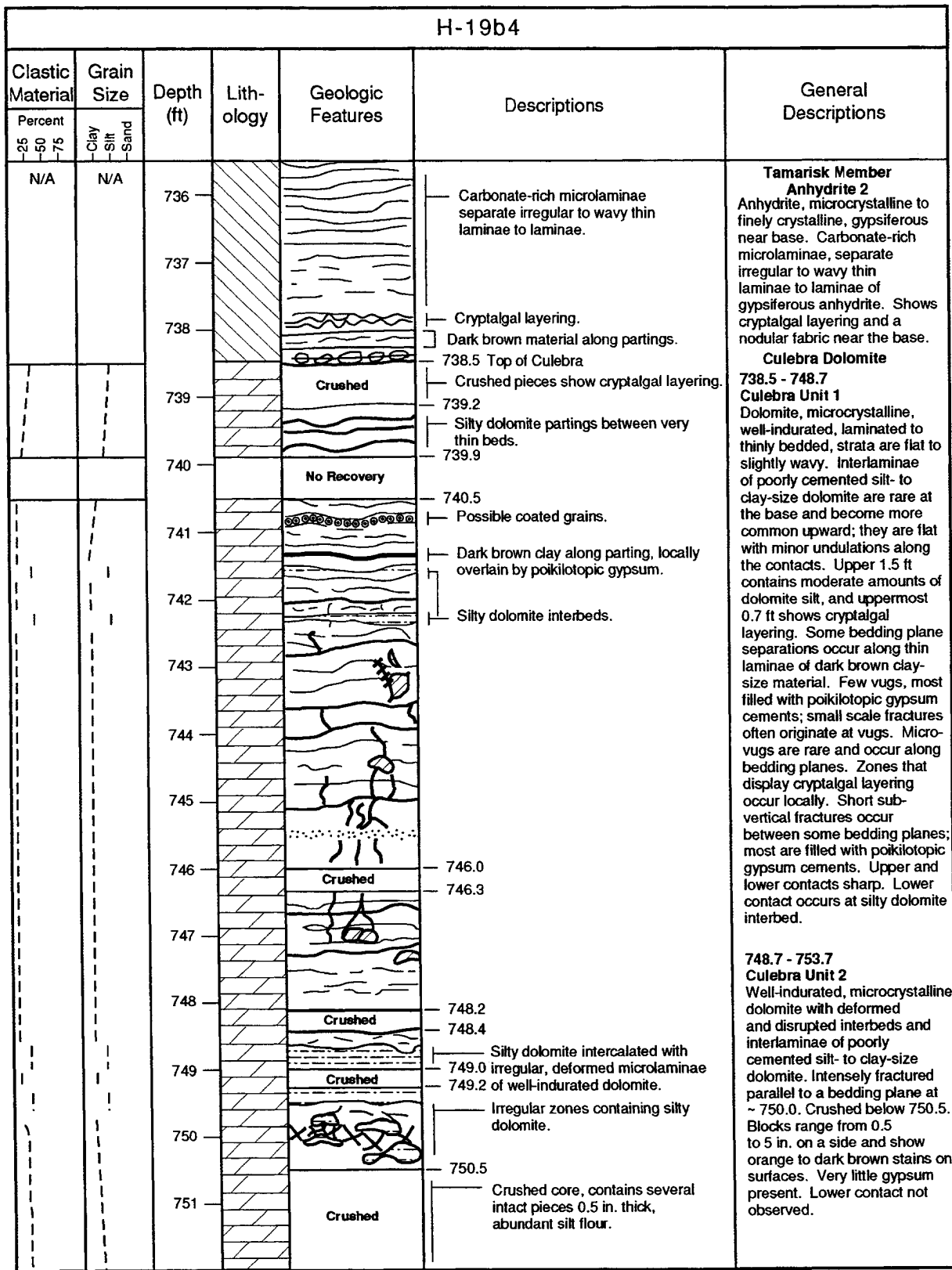

TRI-6115-899-0

Figure 3-5a. Detailed geologic description of the Culebra interval from H-19b4.

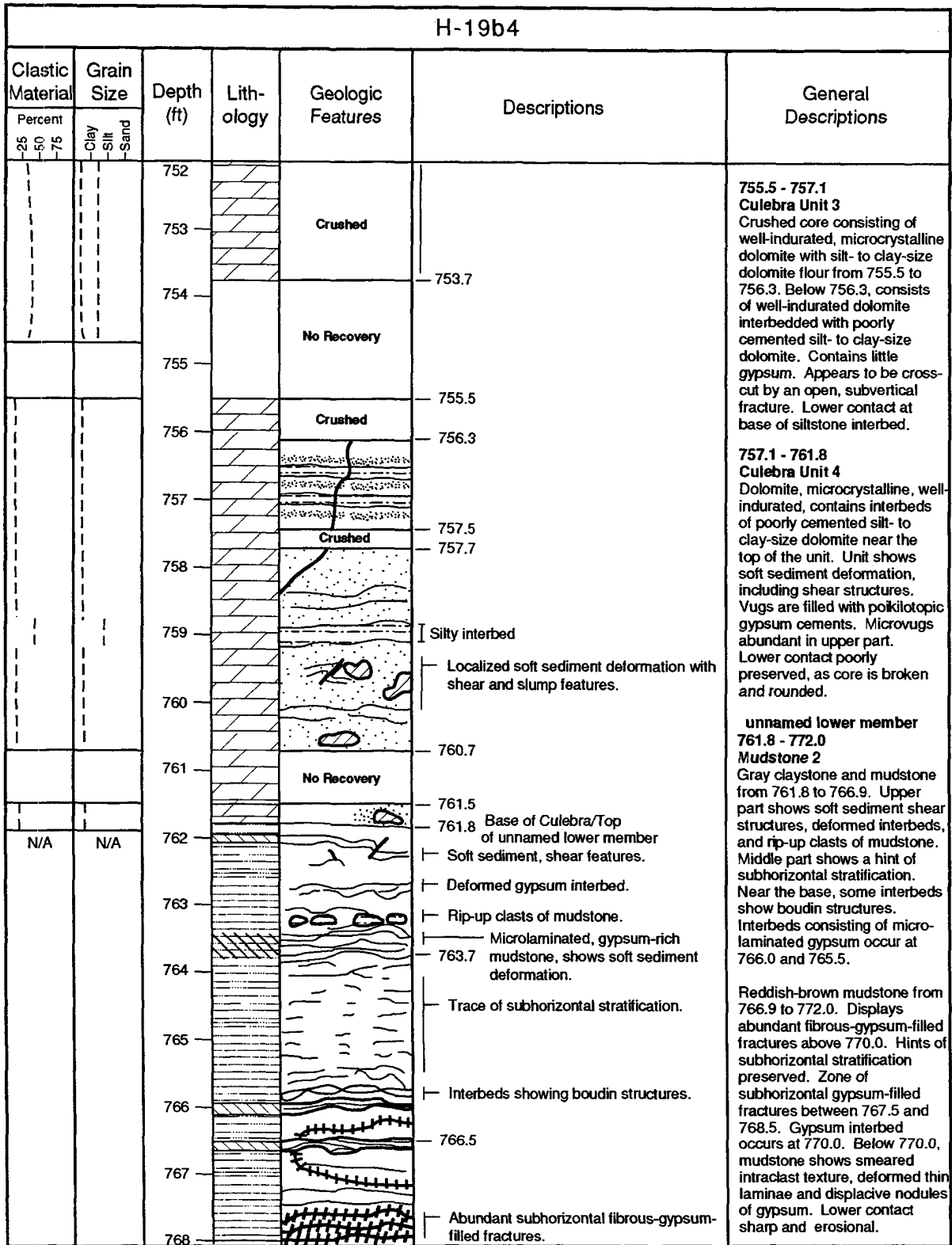

TRI-6115-900-0

Figure 3-5b. Detailed geologic description of the Culebra interval from H-19b4.

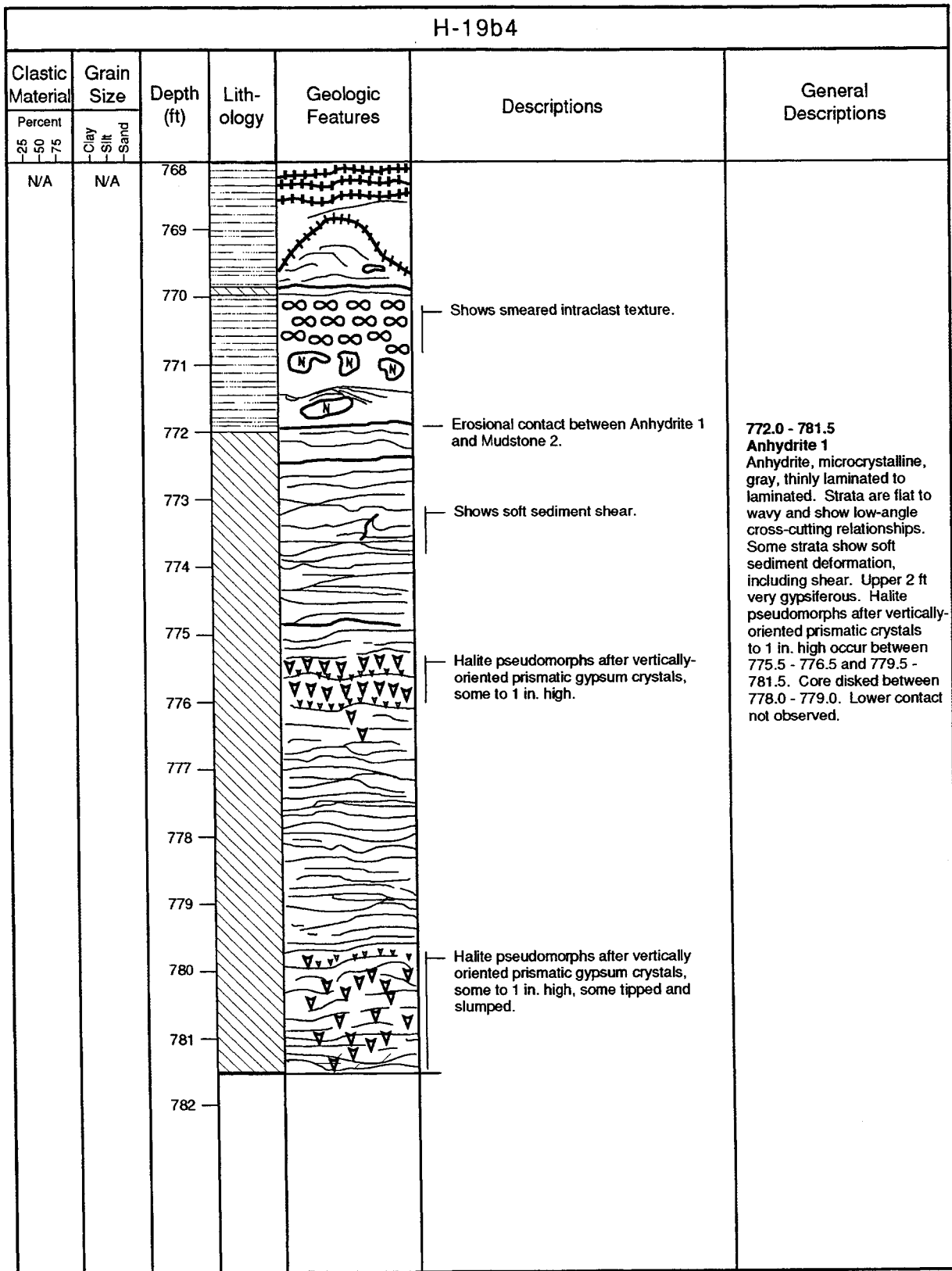

TRI-6115-901-0

Figure 3-5c. Detailed geologic description of the Culebra interval from H-19b4.

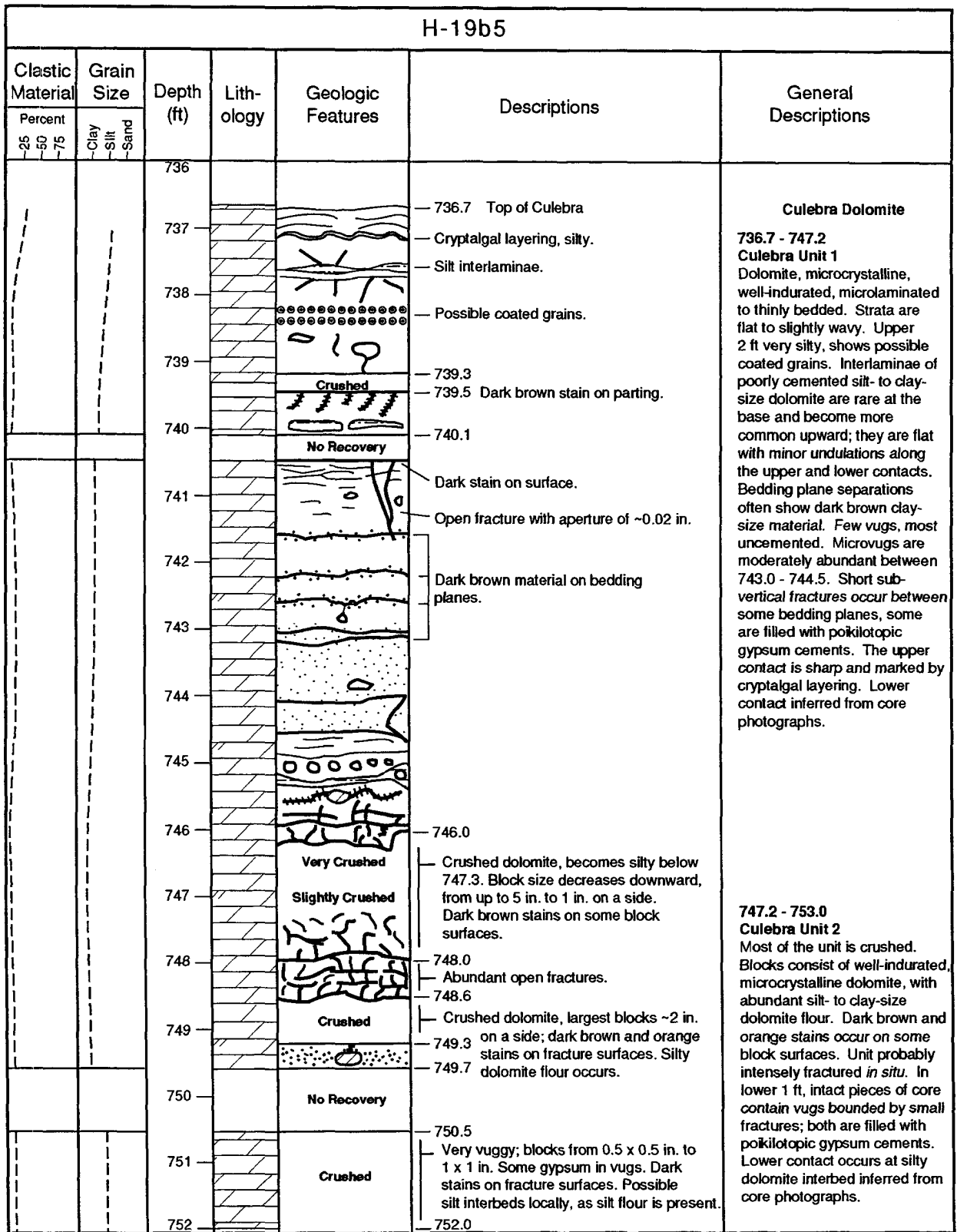

TRI-6115-902-0

Figure 3-6a. Detailed geologic description of the Culebra interval from H-19b5.

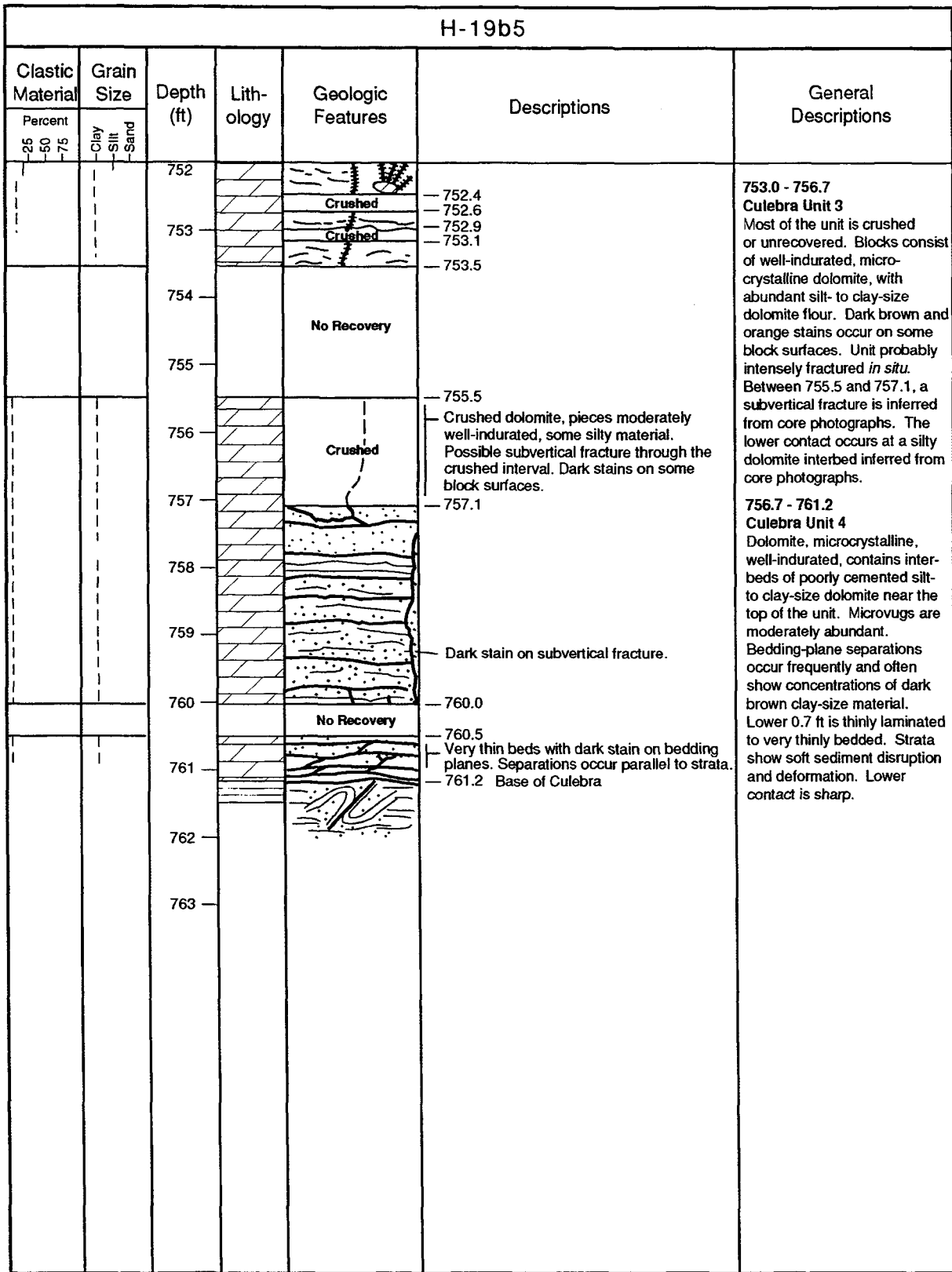

TRI-6115-903-0

Figure 3-6b. Detailed geologic description of the Culebra interval from H-19b5.

H-19b6						
Clastic Material	Grain Size	Depth (ft)	Lithology	Geologic Features	Descriptions	General Descriptions
25 50 75	Clay -Silt -Sand					
N/A	N/A	736			— Top of core	Tamarisk Member Anhydrite 2
		737				Anhydrite, microcrystalline to finely crystalline, gypsiferous near base. Carbonate-rich microlaminae separate irregular to wavy thin laminae to laminae of gypsiferous anhydrite. Lower contact sharp.
		738				Culebra Dolomite
		739			— 739.0	739.0 - 749.1 Culebra Unit 1
		740			Partly crushed, silty, shows cryptalgal layering. Contains a few vugs; some open microfractures.	Dolomite, microcrystalline, well-indurated, microlaminated to thinly bedded. Strata are flat to slightly wavy. Upper 1.5 ft very silty. Interlaminae of poorly cemented silt- to clay-size dolomite are rare at the base and become more common upward; they are flat with minor undulations along the upper and lower contacts. Bedding plane separations often show dark brown clay-size material. Few vugs, most uncemented. Short subvertical fractures occur between some bedding planes; some are filled with poikilotopic gypsum cements. The upper contact is sharp and marked by cryptalgal layering. Lower contact occurs at silty dolomite interbed (inferred from core photographs).
		741		No Recovery	— 740.5	
		742		Crushed Dolomite	— 741.5 Silty — 742.0	
		743			Subvertical fractures filled with poikilotopic gypsum.	
		744			Slightly crushed, dark brown stain on subhorizontal parting.	
		745			Dark brown stain on subhorizontal parting.	
		746		No Recovery	— 745.5	
		747			— 746.5	749.1 - 753.7 Culebra Unit 2
		748			Core mainly crushed. Texture interpreted from core photo. At least two nearly vertical fractures in this zone, they may persist for up to 2 ft. Dark stains are present on some fracture surfaces. Poikilotopic fracture fillings 0.05 to 0.1 in. thick. Some gypsum-filled vugs to 0.5 in. thick. Possible thick silty interbeds between 749.1 to 749.4 and 750.1 to 750.2.	Most of the unit is crushed or unrecovered. Blocks consist of well-indurated, microcrystalline dolomite, with abundant silt- to clay-size dolomite flour. Dark brown and orange stains occur on some block surfaces. Unit probably intensely fractured <i>in situ</i> . In core photographs, small - to moderate-size blocks show a general vertical fabric. Some core pieces show gypsum-cemented vugs to 0.75 in. diameter and poikilotopic gypsum fracture fillings to 0.1 in. thick. May have originally had some silty interbeds as core pieces are coated with a silt- to clay-size dolomite flour. Lower contact not observed.
		749				
		750				
		751		No Recovery	— 750.6	
		752			— 751.5	

TRI-6115-904-0

Figure 3-7a. Detailed geologic description of the Culebra interval from H-19b6.

H-19b6						
Clastic Material	Grain Size	Depth (ft)	Lithology	Geologic Features	Descriptions	General Descriptions
		752				<p>755.2 - 757.2 Culebra Unit 3 Most of the unit is crushed or unrecovered. Blocks consist of well-indurated, microcrystalline dolomite, with abundant silt- to clay-size dolomite flour. Dark brown and orange stains occur on some block surfaces. Unit probably intensely fractured <i>in situ</i>. Lower contact not observed.</p> <p>759.2 - 761.5 Culebra Unit 4 Dolomite, microcrystalline, well-indurated, may contain interbeds of poorly cemented silt- to clay-size dolomite. Abundant microvugs, 0.05 - 0.1 in. Some subvertical surfaces show a dark brown stain. Very discontinuous, irregular interbed of silt-sized dolomite near top of zone. Some very thin beds contain no vugs and show wavy to thin microlaminae. Some crushed pieces show abundant microfractures with block sizes ~0.5 x 0.5 in. Bedding plane separations occur frequently and often show concentrations of dark brown, clay-size material. Upper and lower contacts not observed.</p>
		753				
		754		No Recovery		
		755		Crushed Dolomite		
		756		Crushed Dolomite	Core partly crushed. Contains larger microvugs to 0.1 in. Some poikilotopic gypsum fracture fillings. Silty dolomite interbeds at 755.8 and 756.1.	
		757		No Recovery		
		758		No Recovery		
		759		Crushed Dolomite		
		760		Crushed Dolomite		
		761		Crushed Dolomite		
		762		No Recovery		
		763		No Recovery		
		764		No Recovery		

TRI-6115-905-0

Figure 3-7b. Detailed geologic description of the Culebra interval from H-19b6.

H-19b7						
Clastic Material	Grain Size	Depth (ft)	Lithology	Geologic Features	Descriptions	General Descriptions
		740			739.5 Top of Culebra Cryptalgal layering, silty, mainly crushed parts along subhorizontal bedding planes; partings show dark brown material.	<p>Culebra Dolomite</p> <p>739.5 - 748.7 Culebra Unit 1 Dolomite, microcrystalline, well-indurated, microlaminated to thinly bedded. Strata are flat to slightly wavy. Upper 1 ft very silty. Interlaminae of poorly cemented silt- to clay-size dolomite are rare at the base and become more common upward; they are flat with minor undulations along the upper and lower contacts. Bedding plane separations often show dark brown, clay-size material. Few vugs, most cemented with gypsum. Microvugs are moderately abundant between 743.0 - 745.9. Short subvertical fractures occur between some bedding planes. Most fractures are filled with poikilotopic gypsum cements. The upper contact is sharp and marked by cryptalgal layering. Lower contact occurs at a silty dolomite interbed inferred from core photographs.</p> <p>748.7 - 753.5 Culebra Unit 2 Most of the unit is crushed or unrecovered. Blocks consist of well-indurated, microcrystalline dolomite, with abundant silt- to clay-size dolomite flour. Dark brown and orange stains occur on some block surfaces. Unit probably intensely fractured <i>in situ</i>. In core photographs, small -to moderate-size blocks show a general vertical fabric. Some vugs 0.1 - 0.5 in. diameter. Blocks range in size from ~0.5 x 0.5 in. to 1 x 1 in. Probable silt interlaminae locally, as silt flour abundant. Fracture surfaces show dark brown and orange stains. Probable subvertical fracture below 752.0, as shown in core photo. Few microvugs. Lower contact not observed.</p>
		741		No Recovery	740.6	
		741		Crushed	741.0 741.5 Crushed dolomite, large well-indurated piece above crushed, silty, dolomite.	
		742			Irregular, deformed silt interbed with dark material at the base.	
		743				
		744				
		745				
		746		No Recovery	745.9 746.0	
		747		Crushed	Very crushed, rotated, and silty at base of zone; more intact near top. Few microvugs. Core photo suggests possible subvertical fractures near base. Surfaces of blocks show orange and dark brown stains.	
		748				
		749		No Recovery	748.7	
		750				
		751			750.2 Silty dolomite at top; dark stain behind poikilotopic gypsum fracture filling. 750.7	
		752		Crushed		
		753			753.2	
		754		No Recovery		
		755			754.7	

TRI-6115-906-0

Figure 3-8a. Detailed geologic description of the Culebra interval from H-19b7.

H-19b7							
Clastic Material	Grain Size	Depth (ft)	Lithology	Geologic Features	Descriptions	General Descriptions	
							Percent
		755			<p>Mostly crushed with a few intact pieces to 0.3 ft thick. Abundant microvugs to 0.1 in. Most fracture surfaces show dark stains and no gypsum, although poikilotopic gypsum is present on a few fracture surfaces.</p>	<p>754.7 - 757.5 Culebra Unit 3 Most of the unit is crushed or unrecovered. Blocks consist of well-indurated, microcrystalline dolomite, with abundant silt- to clay-size dolomite flour. Dark brown and orange stains occur on some block surfaces. Unit probably intensely fractured <i>in situ</i>. Poikilotopic gypsum present on a few fracture surfaces. Upper contact not observed. Lower contact at silty dolomite interbed inferred from core photograph.</p>	
		756					
		757					
		758					
		759					
		759.0			No Recovery		
		760			759.7	<p>Pieces of intact core 0.2 - 0.3 ft thick separated by crushed regions 0.1 - 0.2 ft thick.</p>	<p>757.5 - 762.4 Culebra Unit 4 Most of unit is crushed or unrecovered. Blocks consist of well-indurated, microcrystalline dolomite, with some silt- to clay-size dolomite flour. Dark brown and orange stains occur on some block surfaces. Pieces of intact core 0.2 - 0.3 ft thick separated by crushed regions 0.1 - 0.2 ft thick. Completely crushed below 761.6 ft. Abundant microvugs, up to 5%, are filled with gypsum. A few larger, 1/2 inch-scale, dark brown, stained fracture surfaces are evident. Lower contact not observed.</p>
		761					
		762					
		762.4			No Recovery		
		763		No Recovery			
		764		No Recovery			
		765					

TRI-6115-907-0

Figure 3-8b. Detailed geologic description of the Culebra interval from H-19b7.

Table 3-1. Thicknesses of Culebra Hydrostratigraphic Units in H-19 Cores

Well	CU-1 Core Thickness (ft)	CU-2 Core Thickness (ft)	CU-3 Core Thickness (ft)	CU-4 Core Thickness (ft)	Total Core Thickness (ft)
H-19b0	9.8 ⁺	5.4	3.3	5.8	24.3 ⁺
H-19b2	9.7	3.7 ⁺	Not Recovered	0.7 ⁺	14.1 ⁺
H-19b3	11.0 ⁻	4.3 ⁺	Not Recovered	Not Recovered	15.3 ⁺
H-19b4	10.2	5.0 ⁺	1.6 ⁺	4.7	21.5 ⁺
H-19b5	10.5	5.8	3.7	4.5	24.5
H-19b6	10.1	4.6	2.0 ⁺	2.3 ⁺	19.0 ⁺
H-19b7	9.2	4.8 ⁺	2.8 ⁺	4.9 ⁺	21.7 ⁺
Average	9.9 ⁺	5.2 ⁺	3.5 ⁺	5.0 ⁺	23.6 ⁺

NOTE: Total core thickness is a sum of the average thickness of each hydrostratigraphic unit.

+ Upper or lower contact of the unit was not present in the core, and unit thickness is greater than the thickness listed.

- Amount of core loss assigned to the interval containing the hydrostratigraphic unit may be too great, yielding a thickness that is too large.

* Averages include only complete core intervals (those not marked by + or -).

Dark brown stains also occur along other bedding-plane separations. Laminae of poorly cemented, silt- to clay-size (chalky) dolomite are rare at the base, but become more common upward. The laminae are flat with minor undulations along the contacts. Core often separates along these interlaminae. Partially cemented chalky dolomite with cryptalgal layering makes up the upper 1 to 2 ft of CU-1. These features are consistent with the organic-rich, crinkled “algal” laminae or stromatolitic mounds observed at the upper contact of the Culebra by Holt and Powers (1984, 1988). This zone may also contain oolites or coated grains. Fractures are less common than in lower units, are usually parallel to bedding planes, or may propagate subvertically from bedding plane to bedding plane. CU-1 typically contains very few large vugs, although microvugs are common and frequently parallel stratification. Poikilotopic gypsum cements fill some vugs, microvugs, and fractures. The upper contact of the Culebra is sharp and distinct.

The thickness of the second hydrostratigraphic unit (CU-2) varies between 4.6 and 5.8 ft in complete cores from the H-19 hydropad (Table 3-1). CU-2 corresponds to AIS mapping unit 3a. Only three cores from the H-19 hydropad contain the entire thickness of CU-2, and recovered CU-2 core is mostly crushed. CU-2 is intensely fractured in the AIS and was described by Holt and Powers (1990a) as a packbreccia. The term packbreccia (Morrow, 1982) refers to a highly broken rock with limited rotation of the broken pieces. At the H-19 hydropad, CU-2 consists of laminated to thinly bedded dolomite exhibiting cross-cutting relationships. Strata are mostly parallel and flat, although some low-angle cross-stratification, ripple cross-laminae, and ripple forms are preserved. Interbeds of chalky dolomite from 0.5 in. to 3 in. thick become more abundant near the top of CU-2. Subhorizontal burrows up to 2 in. long and 0.5 in. in diameter occur within well-indurated dolomite. Small-scale, soft-sediment deformation is locally abundant as strata are slumped, sheared, and disrupted to varying degrees. Near the base, chalky dolomite strata typically are disrupted and may form irregular masses. Vugs and gypsum

nodules, to 3 in. diameter, are locally abundant in CU-2. In places, these vugs give the unit a honeycombed appearance and disrupt and disconnect strata. Holt and Powers (1988) report that the margins of vugs in the Culebra show soft-sediment displacement. Some vugs are partly to completely collapsed. Nearly all vugs are interconnected by fractures. Crushed core pieces range from <0.5 in. to ~ 4 in. on a side. Based on photographs taken of the cores prior to removal from the core barrel, it is likely that fracture spacings occur at a similar scale. Fracture and block surfaces are frequently stained orange or dark brown. The upper contact of CU-2 is arbitrarily placed at a silty dolomite interbed.

The third hydrostratigraphic unit in the Culebra (CU-3) is between 3.3 and 3.7 ft thick in complete H-19 cores (Table 3-1). It corresponds to AIS mapping unit 3b. At borehole H-19b0, fluid logging indicates that the greatest flow rate into the borehole occurs within CU-3 (Beauheim et al., 1997). Complete recovery of this zone during H-19 coring activities was achieved only at boreholes H-19b0 and H-19b5. Even when all of CU-3 was recovered, the majority of the unit was crushed during coring activities. At the AIS, Holt and Powers (1990a) describe this unit as a packbreccia because of its intensely fractured appearance. Intact pieces of core from CU-3 are rare and show wavy discontinuous thin laminae with some low-angle cross-cutting relationships. Crushed core consists of blocks of well-indurated, microcrystalline dolomite with abundant silt- to clay-size dolomite flour. Blocks range in size from <0.5 in. to ~ 4 in. on a side. The dolomite flour is probably derived from irregular, highly discontinuous and deformed laminae and very thin beds of chalky dolomite found elsewhere in CU-3 (e.g., Holt and Powers, 1990a). Photographs of the core, prior to its removal from the core barrel, show that the unit is intensely fractured. Holt and Powers (1990a) report that large open vugs from this interval are partly to wholly collapsed at the AIS. Fracture surfaces commonly display an orange or dark brown stain. The upper contact of CU-3 is arbitrarily assigned to a silty dolomite interbed that is persistent across the H-19 hydropad.

The lowermost hydrostratigraphic unit (CU-4) corresponds to AIS mapping units 3c and 4. At the H-19 hydropad, its thickness ranges from 4.5 to 5.8 ft in complete cores (Table 3-1). In WIPP shafts, the lower contact of the CU-1 is irregular and undulatory, with undulations up to 3 ft (Holt and Powers, 1986; 1990a). Similar undulations may be present at the H-19 hydropad. The lowermost 0.5 to 0.7 ft consists of thinly laminated to laminated dolomicrite with thin argillaceous partings. This zone is equivalent to AIS mapping unit 4, and at the AIS, the structure of these laminae mimic the lower contact. Where the undulations at the lower contact are most extreme, the laminated dolomite is often brecciated (e.g., Holt and Powers, 1986). Minor amounts of brecciation were observed in this zone at H-19b0. The remainder of CU-1 is thinly laminated to very thinly bedded. These strata are mostly flat to wavy and show low-angle cross-cutting relationships. Near the top of CU-4, several interlaminae of chalky dolomite occur. These interbeds show moderate amounts of soft-sediment deformation. Large gypsum nodules and vugs (up to 1.5 in diameter) may occur in the lower 1 ft of this zone. Some of these nodules and vugs show evidence of collapse. Gypsum-filled, subvertical fractures connected with angular, gypsum-filled pore spaces are preserved in some H-19 cores (e.g., H-19b0). The shapes of these features are consistent with minor amounts of downward displacement with horizontal extension. Cores of CU-4 often separate along bedding planes (spaced 0.2 to 1.0 ft) showing orange or dark brown stains. Gypsum-filled or open, subvertical fractures also showing dark brown or orange stains terminate at these bedding planes. Small, open vugs (<0.1 in) are

common in CU-4 and appear to be concentrated in the vicinity of bedding-plane partings. The upper contact of CU-4 is sharp and is arbitrarily assigned to a silty dolomite interbed.

3.2 Geology of the Rustler Formation at the H-19 Hydropad

The entire Rustler section above the Culebra was cored in borehole H-19b1. The core was described in detail using the informal Rustler stratigraphic subdivisions of Holt and Powers (1988) shown in Figure 3-9. Figures 3-10a, b, and c present a graphic log depicting the geologic features observed in the upper Rustler. In this section, the geologic features observed in each unit and their implications are discussed.

Anhydrite 2 (A-2) is the lowermost unit of the Tamarisk Member and occurs in the depth interval from 722.4 to 732.6 ft. It consists of locally gypsiferous microcrystalline anhydrite interlaminated with minor amounts of carbonate. Between 728.1 and 732.6 ft, A-2 is thinly laminated to very thinly bedded, and strata are wavy with low-angle cross-cutting relationships. Small anhydrite pseudomorphs after vertically oriented prismatic gypsum crystals occur between 730.5 and 730.1 ft. An irregular zone containing large coarsely crystalline gypsum occurs between 731.0 and 732.5 ft. Between 727.65 and 728.1 ft, a siltstone displaying wavy to contorted, thin laminae to laminae and smeared intraclast textures occurs. Above 727.65 ft, gypsiferous anhydrite shows relict thin laminae to very thin beds. Stratification becomes less common above 724.3 ft, and a nodular fabric occurs. Gypsum occurs in irregularly shaped zones below 725.5 ft, and a zone containing coarsely crystalline gypsum occurs at 725.0 ft. The upper contact of A-2 is sharp and irregular. The lower contact of A-2 was not observed.

Mudstone 3 (M-3) occurs in the Tamarisk in the depth interval from 709.25 to 722.4 ft. Between 720.3 and 722.4 ft, M-3 consists of mudstone. It displays abundant rounded to angular pebbles and granules of gray and red siltstone showing soft-sediment deformation and small angular cobbles of anhydrite and microlaminated mudstone. Smeared intraclast textures (e.g., Holt and Powers, 1988) are also present. Some fractures filled with fibrous gypsum cross-cut breccia clasts. A large, displaced block of laminated anhydrite occurs between 718.5 and 720.3 ft. Mudstone-supported pebbles of siltstone and mudstone occur between 718.2 and 718.5 ft. The upper surface of the mudstone shows slickensides that do not parallel the dip of the contact. Between 717.25 and 718.2 ft, a second large, displaced block of laminated anhydrite occurs. Strata within the displaced blocks of anhydrite are discordant with the block-bounding surfaces. Above 717.25 ft, M-3 consists of mudstone-supported granule- to cobble-size breccia clasts of mudstone and laminated anhydrite. Smeared intraclast textures are preserved locally. The upper contact of M-3 is sharp.

Anhydrite 3 (A-3), the uppermost unit in the Tamarisk, occurs in the depth interval between 650.3 and 709.25 ft. It consists of microcrystalline anhydrite interlaminated with minor amounts of carbonate. Holt and Powers (1988) subdivided A-3 into three zones, which are present in the H-19b1 core. The lower zone, A-3a, occurs between 685.0 and 709.25 ft. Strata are wavy to slightly irregular thin laminae and very thin beds showing low-angle cross-cutting relationships. Anhydrite rip-up clasts occur at 708.5 ft. Anhydrite pseudomorphs after vertically oriented prismatic gypsum crystals become more common upward and range in size from <0.06 in. to >2 in. The middle zone, A-3b, occurs between 667.0 and 685.0 ft. Strata are wavy, thin laminae to very thin beds showing low-angle cross-cutting relationships and soft-sediment deformation. The crushed prism texture (Holt and Powers, 1988) characterizes this zone.

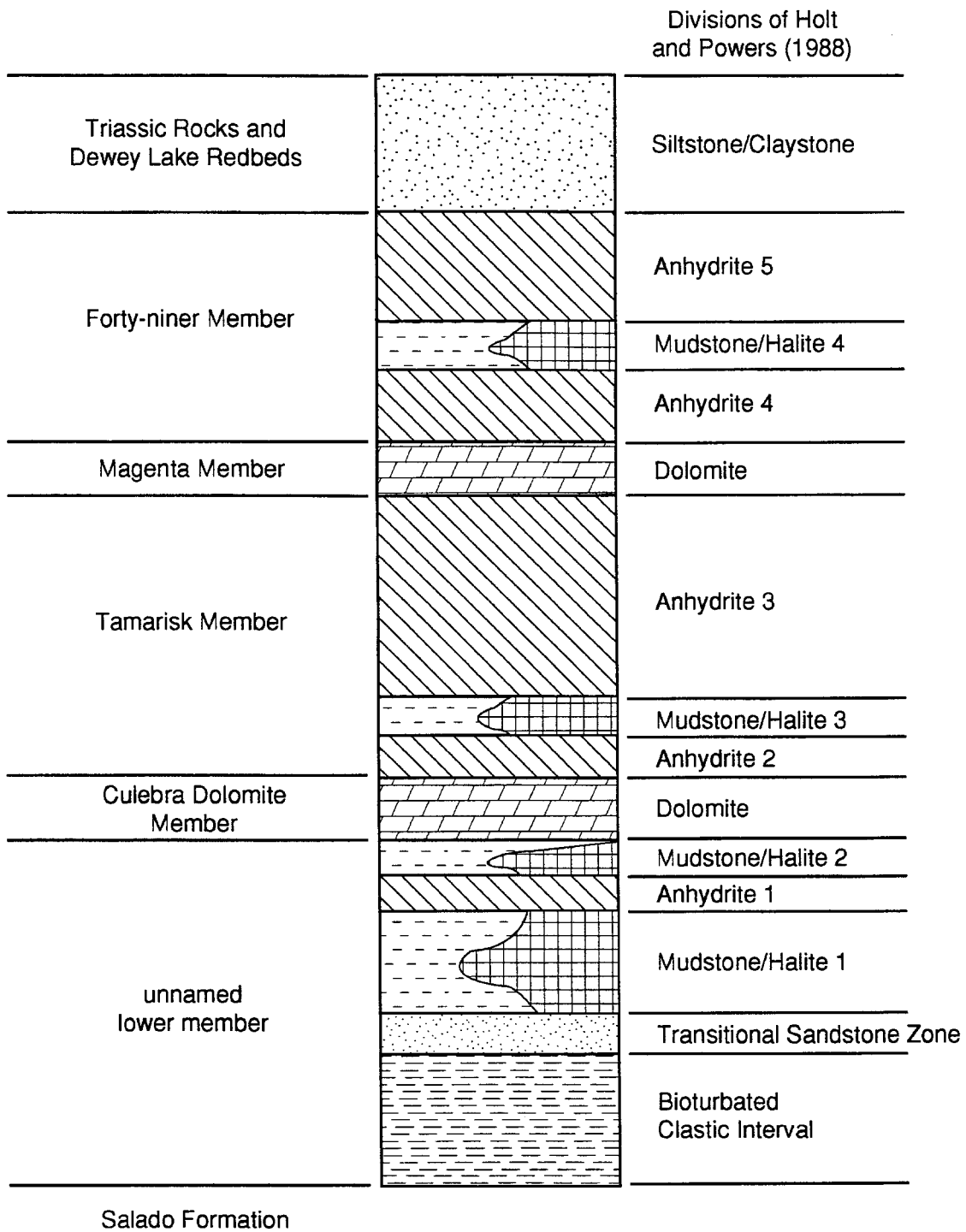

TRI-6115-912-0

Figure 3-9. Rustler stratigraphy.

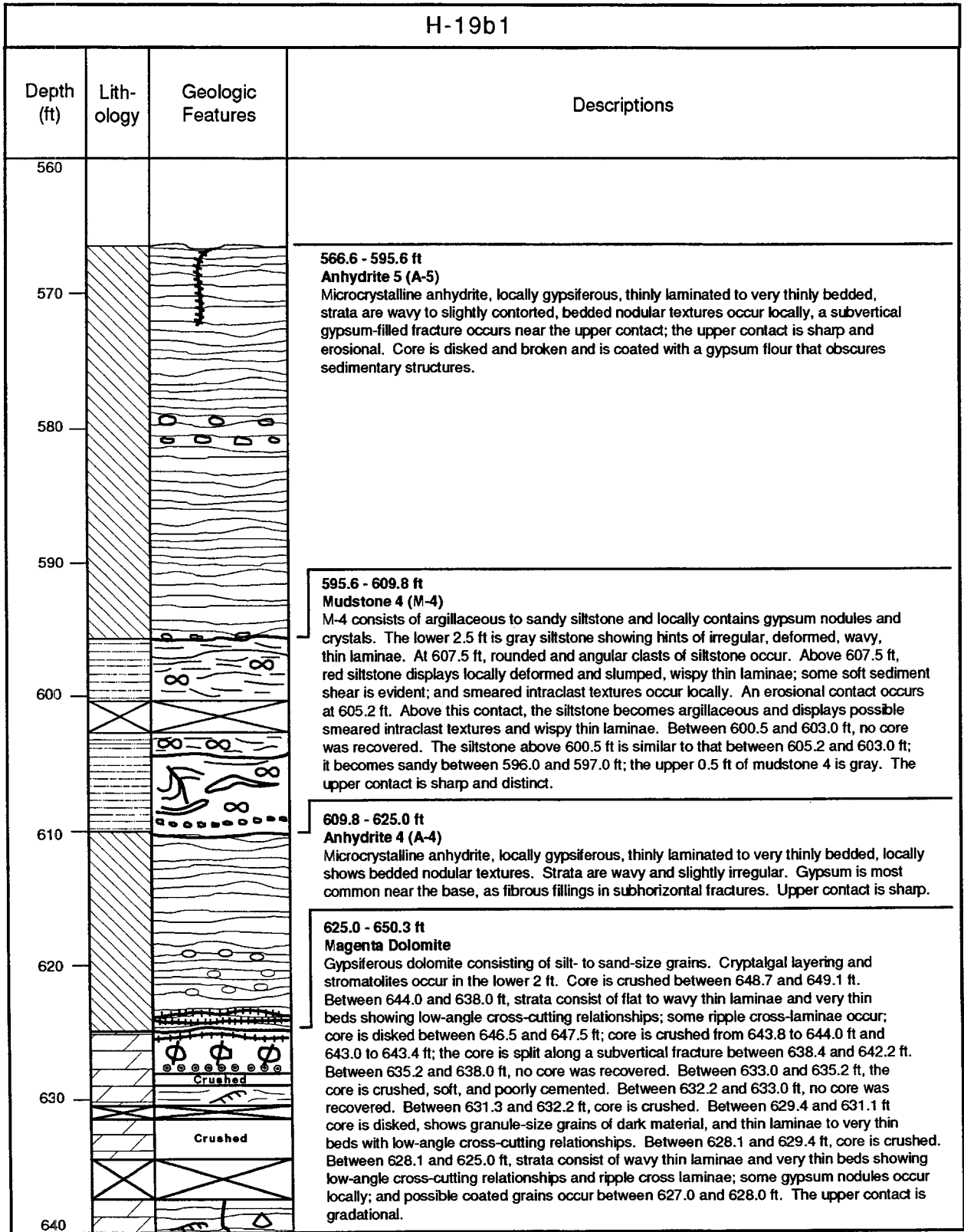

TRI-6115-908-0

Figure 3-10a. Detailed geologic description of the upper Rustler interval from H-19b1.

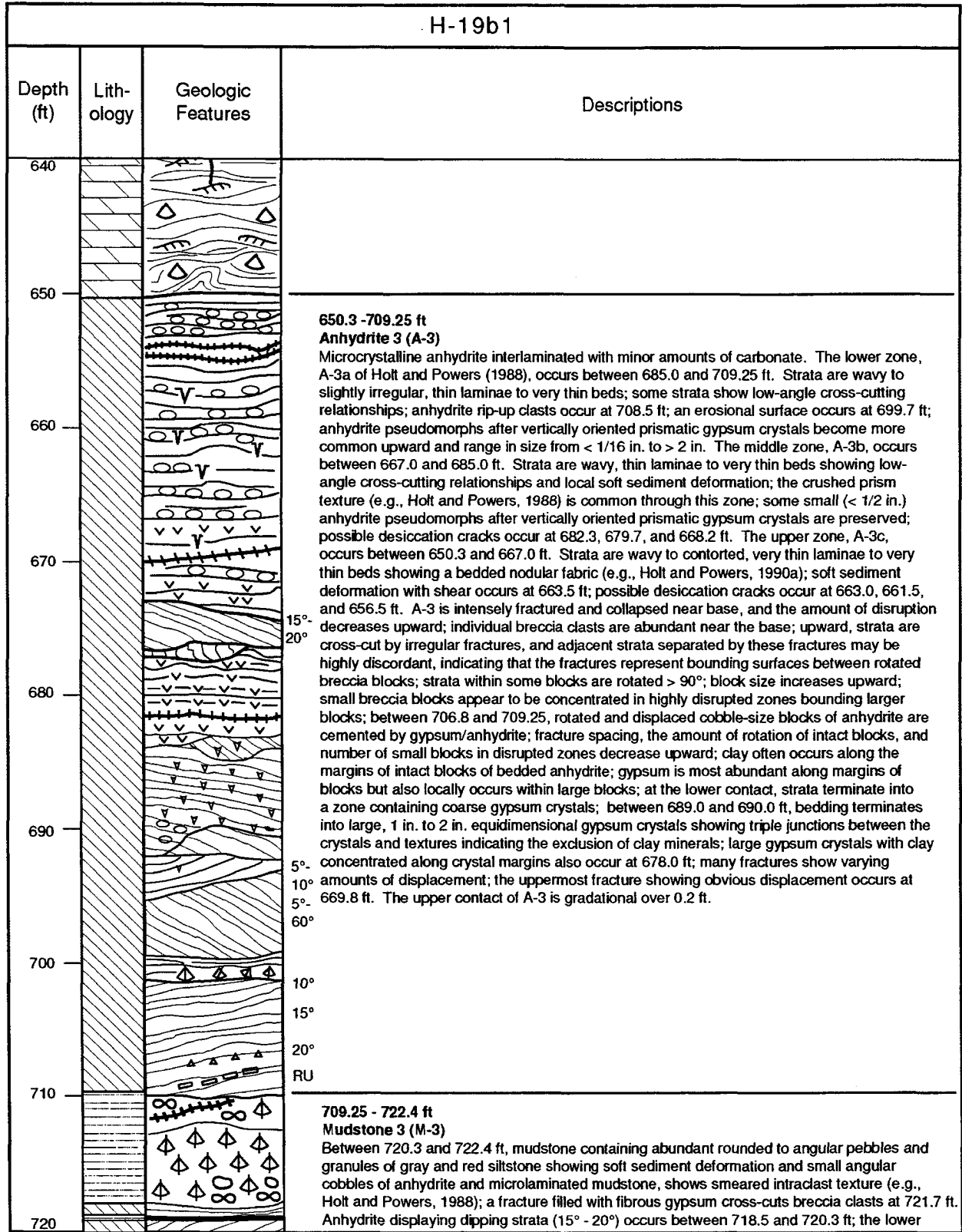

TRI-6115-909-0

Figure 3-10b. Detailed geologic description of the upper Rustler interval from H-19b1.

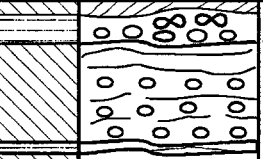
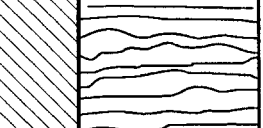
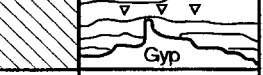
H-19b1			
Depth (ft)	Lithology	Geologic Features	Descriptions
720			<p>surface dips > 20°; strata terminate discordantly along the lower surface indicating that this is a floating block of down-dropped anhydrite; a fracture containing fibrous gypsum occurs at the lower surface, and fibers are oriented horizontally. Between 718.2 and 718.5 ft, mudstone containing pebbles of siltstone and mudstone occurs; the upper surface shows slickensides that do not parallel the dip of the contact. Between 717.25 and 718.2 ft, laminated anhydrite occurs; strata are discordant with the lower contact. Between 709.25 and 717.25, mudstone contains granule- to cobble-size breccia clasts of mudstone and laminated anhydrite; smeared intraclast textures are preserved locally; most breccia occurs between 711.5 and 716.0 ft. The upper contact of M-3 is sharp.</p> <p>722.4 - 732.6 ft Anhydrite 2 (A-2) Microcrystalline anhydrite interlaminated with minor amounts of carbonate, locally gypsiferous. Between 728.1 and 732.6 ft, anhydrite is thinly laminated to very thinly bedded, strata are wavy with low angle cross-cutting relationships, and small anhydrite pseudomorphs after vertically oriented prismatic gypsum crystals occur between 730.5 and 730.1 ft; an irregular zone containing large coarsely crystalline gypsum occurs between 731.0 and 732.5 ft. Between 727.65 and 728.1 ft, a siltstone displaying wavy to contorted, thin laminae to laminae and smeared intraclast textures occurs. Between 722.4 and 727.65, gypsiferous anhydrite occurs; it shows relict thin laminae to very thin beds; it becomes nodular above 724.3 ft; gypsum occurs in irregularly shaped zones below 725.5 ft; a zone containing coarsely crystalline gypsum occurs at 725.0 ft. The upper contact of A-2 is sharp and irregular. The lower contact of A-2 was not observed.</p>
730			
740			

TRI-6115-910-0

Figure 3-10c. Detailed geologic description of the upper Rustler interval from H-19b1.

Some small (<0.5 in.) anhydrite pseudomorphs after vertically oriented prismatic gypsum crystals are preserved. The upper zone, A-3c, occurs between 650.3 and 667.0 ft. Strata consist of wavy to contorted, very thin laminae to very thin beds showing a bedded nodular fabric (Holt and Powers, 1990a). In both A-3b and A-3c, possible desiccation cracks occur locally. The upper contact of A-3 is gradational over 0.2 ft.

A-3 is intensely fractured and collapsed near its base; the amount of collapse decreases upward. Individual breccia clasts are more abundant and smaller near the base of A-3. The block size increases upward and, in general, the amount of rotation decreases. Large blocks are distinguished by dipping strata that are discordant with bounding surfaces. Strata within some blocks are rotated >90°. Small breccia blocks appear to be concentrated in highly disrupted zones bounding larger blocks. Clay often occurs along the margins of intact, rotated blocks of bedded anhydrite. Gypsum is most abundant along margins of blocks but also occurs locally within large blocks. Gypsum textures indicating possible recrystallization occur locally. These textures include: strata terminating into a zone containing coarse gypsum crystals, large equidimensional gypsum crystals showing intercrystalline triple junctions, and textures indicating the exclusion of clay minerals. The uppermost fracture showing obvious displacement occurs at 669.8 ft.

The Magenta Member of the Rustler Formation occurs in the depth interval between 625.0 and 650.3 ft. The Magenta consists of gypsum- and dolomite-cemented silt- to sand-size grains of dolomite. Cryptalgal layering and stromatolites occur in the lower 2 ft. Strata within the remainder of the unit consist of flat to wavy to lenticular thin laminae and very thin beds showing low-angle cross-cutting relationships. Some ripple cross-laminae also occur. The condition of the Magenta core generally is poor when compared to other WIPP cores. The core shows moderate diskings locally and is crushed in several intervals. In addition, the core is split along a subvertical fracture between 638.4 and 642.2 ft. No core was recovered between 635.2 and 638.0 ft. In general, the lower portion of the Magenta is soft and poorly cemented. Some gypsum nodules are present, and coated grains occur between 627.0 and 628.0 ft. The upper contact is gradational.

Anhydrite 4 (A-4) is the lowermost unit of the Forty-niner Member and occurs in the depth interval from 609.8 to 625.0 ft. A-4 consists of locally gypsiferous microcrystalline anhydrite. It is thinly laminated to very thinly bedded and locally shows bedded nodular textures. Strata are wavy and slightly irregular. Gypsum is most common near the base, where it occurs as fibrous fillings in subhorizontal fractures. The upper contact is sharp.

Mudstone 4 (M-4) occurs in the Forty-niner in the depth interval from 595.6 to 609.8 ft. It consists of argillaceous to sandy siltstone and locally contains gypsum nodules and crystals. The lower 2.5 ft is gray siltstone showing hints of irregular, deformed, wavy, thin laminae. At 607.5 ft, rounded and angular clasts of siltstone occur. Above 607.5 ft, red siltstone displays wispy thin laminae that are locally deformed and slumped, and some soft-sediment shears and smeared intraclast textures are evident locally. An erosional contact occurs at 605.2 ft. Above this contact, the siltstone becomes argillaceous and displays possible smeared intraclast textures and wispy thin laminae. No core was recovered between 600.5 and 603.0 ft. Sandy siltstone occurs between 596 and 597 ft. The upper 0.5 ft of M-4 is gray. The upper contact is sharp and distinct.

Anhydrite 5 (A-5) is the uppermost unit of the Forty-niner and occurs in the depth interval from 566.6 to 595.6 ft. Core from A-5 is disked and broken and coated with a gypsum flour that obscures sedimentary structures. It is a locally gypsiferous, microcrystalline anhydrite with wavy to slightly contorted, thin laminae to very thin beds. Bedded nodular textures occur locally. The upper contact of A-5 with the Dewey Lake Redbeds is sharp and erosional.

The sedimentary structures observed in the Rustler at H-19b1 are consistent with those reported by Holt and Powers (1988, 1990a) and Powers and Holt (1990). Rustler units above A-2, however, show evidence of upward stoping, brecciation, and collapse. Stratigraphic disruption appears to originate in the M-3/H-3 interval. These features are strong evidence of post-depositional dissolution (Holt and Powers, 1990a). The collapse features observed at H-19b1 are similar to those reported at H-3b3 by Holt and Powers (1988). At H-3b3, Holt and Powers (1988) estimate that as much as 30 ft of halite was removed from the M-3/H-3 interval. They also report minor amounts of collapse originating in the M-3/H-3 interval at H-11. Holt and Powers (1988) suggest that, if present, post-depositional dissolution of halite from Rustler mudstone/halite units would most likely be found in a boundary zone between the region known to contain halite and the region where sedimentary features indicate that halite did not survive the deposition of the overlying unit. They also suggest that boreholes H-3b3 and H-11 fall within this zone. The H-19 hydropad is situated in the same region. Because the disruption observed at H-19b1 occurs above the Culebra, it is unlikely to have affected Culebra hydraulic properties. The vertically averaged hydraulic conductivity of the Magenta, however, may be increased at the H-19 hydropad.

The timing of the dissolution and collapse observed at H-19b1 remains unknown. Nevertheless, some timing relationships are evident in the core. Because fractures filled with fibrous gypsum cross-cut and bound some breccia clasts, these fractures must post-date dissolution and collapse. The fibrous habit of the fracture-filling gypsum indicates that the fractures were filled with gypsum as they opened (Holt and Powers, 1990a; Durney and Ramsay, 1973). The age of these fractures is unknown, but they may be very old. Similar gypsum-filled fractures in the Dewey Lake Redbeds developed syndepositionally (Holt and Powers, 1990a; e.g., Figure 16).

3.3 Perched Water Tables in the Dewey Lake Redbeds

The entire section of Dewey Lake Redbeds was cored at H-19b1. During the drilling, moisture was first encountered at a depth of 184 ft. At boreholes WQSP-6 and 6a, 1.2 miles west of H-19, a perched water table was encountered at a depth of approximately 164 ft (Beauheim and Ruskauff, 1998). In addition, water has been encountered in several boreholes near the southern WIPP-site boundary and several stock wells south of the WIPP site are possibly completed in a perched aquifer in the upper Dewey Lake Redbeds (Mercer, 1983). Holt and Powers (1990a), who also described moisture in the upper part of the Dewey Lake at the AIS, noted that the lower part of the Dewey Lake Redbeds was cemented with a very hard material, probably anhydrite or gypsum, and was characterized by abundant gypsum-filled fractures. They reported that the upper Dewey Lake was poorly indurated, weakly cemented with carbonate, contained no gypsum-filled fractures, and was moist (Holt and Powers, 1990a). The transition between the two cement types was abrupt and occurred at a depth of 164.5 ft. Coincident with this change in cement, fractures became filled with fibrous gypsum, and no moisture was

observed below the cement contact. Holt and Powers (1990a) hypothesized that perched water tables elsewhere in the Dewey Lake may rest on this cement change. Supporting their hypothesis, borehole video logs from WQSP-6a reveal that most water inflow into the borehole occurs above the first occurrence of gypsum-filled fractures.

A portion of the Dewey Lake core from borehole H-19b1 was described in detail to test the Holt and Powers (1990a) hypothesis. Based on the reported first occurrence of moisture, the depth interval between 169.0 and 209.4 was chosen for description. In this interval, the Dewey Lake Redbeds consist of interbedded medium to very fine sand and silt in upward fining sequences ranging from <1.0 to ~ 4.0 ft thick. Strata are primarily flat thin laminae to very thin beds, although some ripple cross-stratification and low-angle cross-cutting relationships are evident in the core. Some soft-sediment slump features, including probable pillow structures, are present. Rip-up clasts occur locally. Below a depth of 201.0 ft, the Dewey Lake sediments are well-indurated and hard, poikilotopic cements are evident along broken pieces of core, and fractures are filled with fibrous gypsum. Above 201.0 ft, the Dewey Lake is poorly indurated and soft. Bedding-plane separations and other fractures have no gypsum fillings or linings, although some fracture surfaces appear to have a carbonate coating. Open fractures are occasionally preserved within intact pieces of core.

The Holt and Powers hypothesis is supported by the observations at H-19b1. The cement change observed by Holt and Powers (1990a) at the AIS is also present at H-19b1, in roughly the same stratigraphic position (365 ft above the Rustler/Dewey Lake contact at H-19b1 vs. 348.5 ft above the contact at the AIS), and moisture appears at 184 ft. Thus, it is likely that this cement change has significant areal extent. The reduction in permeability caused by the cement change probably represents a significant impediment to vertical infiltration of water. If the infiltration rate exceeds the vertical, saturated hydraulic conductivity of the well-cemented portion of the Dewey Lake, ponding will occur on the surface defined by the cement change. Under these conditions, local relief on the surface will define the areal extent of any perched water zone.

Holt and Powers (1990a) also suggested that this cement change may reflect the depth and extent of infiltration of recent meteoric water. Evidence from Nash Draw, however, does not support this assertion. The lower part of the Dewey Lake is exposed along the southern part of Livingstone Ridge. Stratigraphically higher sections of the Dewey Lake are exposed northward along Livingstone Ridge. Along Livingstone Ridge, the Dewey Lake is unconformably overlain by the Gatuña Formation and the Mescalero caliche. The Mescalero caliche began to form approximately 510,000 years ago (Bachman, 1985). If the cement difference observed in the subsurface is related to the dissolution of cements from Gatuña-age or younger near-surface groundwaters, no gypsum fracture fillings would be preserved in Dewey Lake outcrops. However, fibrous gypsum fracture fillings are present in Dewey Lake outcrops along most of Livingstone Ridge. In the uppermost part of the Dewey Lake, e.g., near Maroon Cliffs, no gypsum fracture fillings are observed, suggesting that the cement change is unrelated to recent, or even Cenozoic, processes. Because sulfate cements in the Dewey Lake are in part syndepositional (Holt and Powers, 1990a; 1990b), the cement change observed in the WIPP area may reflect a syndepositional change in groundwater chemistry, or it may indicate dissolution of sulfate cements during a period of intense groundwater circulation (e.g., the Mesozoic). Without further investigation, however, the spatial distribution of this cement change or its origin cannot be known.

3.4 Summary

At the H-19 hydropad, the Culebra can be subdivided into four distinct hydrostratigraphic units. These hydrostratigraphic units correlate with mapping units identified by Holt and Powers (1990a) in the Culebra at the WIPP AIS. The uppermost hydrostratigraphic unit (CU-1) is massively bedded and fractures are primarily subhorizontal, follow bedding planes, and are widely spaced. The average recovered thickness of CU-1 at the H-19 hydropad is 9.9 ft. The second and third hydrostratigraphic units (CU-2 and CU-3) are lithologically similar. They are intensely fractured with fracture spacings as small as 0.5 in. The average recovered thicknesses of CU-2 and CU-3 are 5.2 and 3.5 ft, respectively. The lowermost hydrostratigraphic unit (CU-4) is moderately fractured, and its average recovered thickness is 5.0 ft.

The entire upper part of the Rustler Formation was cored at borehole H-19b1. The sedimentary features preserved in this core are consistent with those reported by Holt and Powers (1988). Textures indicating brecciation, upward stoping, and collapse originate in the Tamarisk Member mudstone (M-3/H-3 of Holt and Powers, 1988). Similar features occur at the H-3 and H-11 hydropads. Holt and Powers (1988) interpreted these features as the product of post-depositional dissolution of halite from the Tamarisk mudstone/halite interval. They suggested that these boreholes occur in a zone that marks the original depositional margin of halite in the Tamarisk Member. The H-19 hydropad is located in the same region.

Several boreholes in the region south of the WIPP site, including H-19b1, have encountered perched water or moist zones in the upper part of the Dewey Lake Redbeds (see Mercer, 1983). In the AIS, moisture was also observed in the upper part of the Dewey Lake (Holt and Powers, 1990a). At the AIS, this moisture occurred above a change in the material cementing the Dewey Lake sediments. Descriptions from the H-19b1 core reveal that moisture encountered during drilling occurs above a similar cement change and support the hypothesis that the cement change is a regional feature that may control the occurrence of water in the upper Dewey Lake Redbeds (Holt and Powers, 1990a).

Page intentionally left blank.

4. REFERENCES

- Bachman, G.O. 1985. *Assessment of Near-Surface Dissolution At and Near the Waste Isolation Pilot Plant (WIPP), Southeastern New Mexico*. SAND84-7178. Albuquerque, NM: Sandia National Laboratories.
- Beauheim, R.L., and R.M. Holt. 1990. "Hydrogeology of the WIPP Site," *Geological and Hydrological Studies of Evaporites in the Northern Delaware Basin for the Waste Isolation Pilot Plant (WIPP), New Mexico, GSA Field Trip #14 Guidebook, November 1-4, 1990*. Dallas, TX: Dallas Geological Society. 131-179.
- Beauheim, R.L., and G.J. Ruskauff. 1998. *Analysis of Hydraulic Tests of the Culebra and Magenta Dolomites and Dewey Lake Redbeds Conducted at the Waste Isolation Pilot Plant Site*. SAND98-0049. Albuquerque, NM: Sandia National Laboratories.
- Beauheim, R.L., L.C. Meigs, and P.B. Davies. 1997. "Rationale for the H-19 and H-11 Tracer Tests at the WIPP Site," *Field Tracer Experiments: Role in the Prediction of Radionuclide Migration, Synthesis and Proceeding of an NEA/EC GEOTRAP Workshop, Cologne, Germany, 28-30 August 1996*. Paris, France: Organization for Economic Co-operation and Development, Nuclear Energy Agency. 107-118.
- Durney, D.W., and J.G. Ramsay. 1973. "Incremental Strains Measured by Syntectonic Crystal Growths," *Gravity and Tectonics*. Eds. K.A. DeJong and R. Scholten. New York, NY: John Wiley & Sons. 67-96.
- Holt, R.M. 1997. *Conceptual Model for Transport Processes in the Culebra Dolomite Member, Rustler Formation*. SAND97-0194. Albuquerque, NM: Sandia National Laboratories.
- Holt, R.M., and D.W. Powers. 1984. *Geotechnical Activities in the Waste Handling Shaft*. WTSD-TME-038. Carlsbad, NM: U.S. Department of Energy by TSC and International Technology Corporation. (Copy on file in the SWCF under WPO#41347.)
- Holt, R.M., and D.W. Powers. 1986. *Geotechnical Activities in the Exhaust Shaft*. DOE-WIPP-86-008. Carlsbad, NM: U.S. Department of Energy, WIPP Project Office. (Copy on file in the SWCF under WPO#41696.)
- Holt, R.M., and D.W. Powers. 1988. *Facies Variability and Post-Depositional Alteration within the Rustler Formation in the Vicinity of the Waste Isolation Pilot Plant, Southeastern New Mexico*. DOE-WIPP-88-004. Carlsbad, NM: U.S. Department of Energy, WIPP Project Office. (Copy on file in the SWCF under WPO#42145.)
- Holt, R.M., and D.W. Powers. 1990a. *Geologic Mapping of the Air Intake Shaft at the Waste Isolation Pilot Plant*. DOE-WIPP 90-051. Carlsbad, NM: U.S. Department of Energy, WIPP Project Office. (Copy on file in the SWCF under WPO#42312.)
- Holt, R.M., and D.W. Powers. 1990b. "The Late Permian Dewey Lake Formation at the Waste Isolation Pilot Plant," *Geological and Hydrological Studies of Evaporites in the Northern Delaware Basin for the Waste Isolation Pilot Plant (WIPP), New Mexico, GSA Field Trip #14 Guidebook, November 1-4, 1990*. Dallas, TX: Dallas Geological Society. 107-129.

Mercer, J.W. 1983. *Geohydrology of the Proposed Waste Isolation Pilot Plant Site, Los Medaños Area, Southeastern New Mexico*. Water Resources Investigations Report 83-4016, Albuquerque, NM: U.S. Geological Survey.

Morrow, D.W. 1982. "Descriptive Field Classification of Sedimentary and Diagenetic Breccia Fabrics in Carbonate Rocks," *Bulletin of Canadian Petroleum Geologists*. Vol. 30, no. 3, 227–229.

Powers, D.W., and R.M. Holt. 1990. "Sedimentology of the Rustler Formation near the Waste Isolation Pilot Plant (WIPP) Site," *Geological and Hydrological Studies of Evaporites in the Northern Delaware Basin for the Waste Isolation Pilot Plant (WIPP), New Mexico, GSA Field Trip #14 Guidebook, November 1–4, 1990*. Dallas, TX: Dallas Geological Society. 79–106.

Saulnier, G.J., Jr., and R.L. Beauheim. 1995. "Field Operations Plan: Well Construction and Preliminary Testing on the H-19 Hydropad at the WIPP Site." Albuquerque, NM: Sandia National Laboratories. (Copy on file in the SWCF under WPO#20472.)

APPENDIX A

Field Operations Plan and Well-Siting Memos

Page intentionally left blank.

CULEBRA TRANSPORT PROGRAM

**FIELD OPERATIONS PLAN:
WELL CONSTRUCTION AND PRELIMINARY TESTING
ON THE H-19 HYDROPAD AT THE WIPP SITE**

**George J. Saulnier, Jr.
INTERA Inc.**

and

**Richard L. Beauheim
Sandia National Laboratories**

February 3, 1995

ACKNOWLEDGEMENTS

The authors thank Jerry Mercer, Allan Sattler, Lucy Meigs, John Pickens, Wayne Stensrud, Don Fulton, and many reviewers for their assistance in preparing this Field Operations Plan.

CULEBRA TRANSPORT PROGRAM

FIELD OPERATIONS PLAN:
WELL CONSTRUCTION AND PRELIMINARY TESTING
ON THE H-19 HYDROPAD AT THE WIPP SITE

Sandia National Laboratories
Albuquerque, NM 87185

Prepared by:

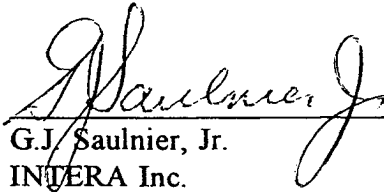
G.J. Saulnier, Jr.
INTERA Inc.

1/18/95
Date

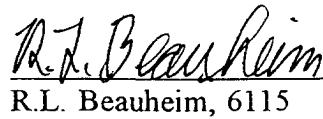
R.L. Beauheim, 6115

Principal Investigator, Geohydrology Dept.

11/28/94
Date

Reviewed by:

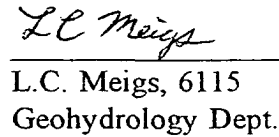

L.C. Meigs, 6115
Geohydrology Dept.

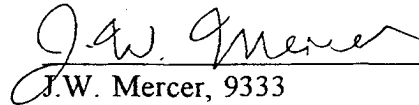
11/28/94
Date

J.W. Mercer, 9333

Engineering Projects and Explosives Applications Dept.

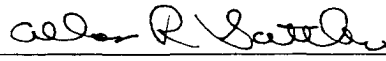
12/2/94
Date

A.R. Sattler, 6111

Geothermal Research Dept.

11/23/94
Date

Organizational
Approvals:

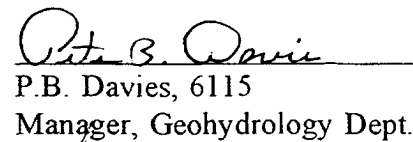
P.B. Davies, 6115
Manager, Geohydrology Dept.

12-6-94
Date

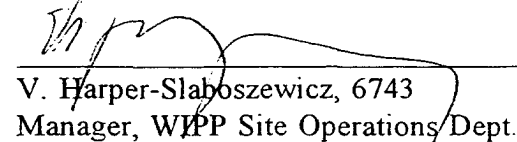
V. Harper-Slaboszewicz, 6743
Manager, WIPP Site Operations Dept.

12/5/94
Date

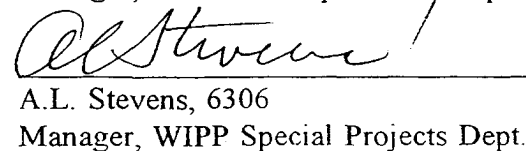
A.L. Stevens, 6306
Manager, WIPP Special Projects Dept.

12/13/94
Date

CULEBRA TRANSPORT PROGRAM

**FIELD OPERATIONS PLAN:
WELL CONSTRUCTION AND PRELIMINARY TESTING
ON THE H-19 HYDROPAD AT THE WIPP SITE**

**Sandia National Laboratories
Albuquerque, NM 87185**

Organizational Approvals (Cont.):



C.J. Mewhinney, 6700
ES&H Coordinator

12/15/94
Date

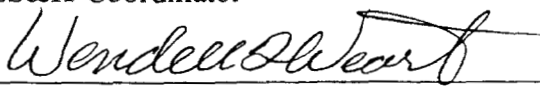

W.D. Weart, 6303
Manager, WIPP Project Dept.

11/29/94
Date

WID Approval: 

C.M. Cox
Manager

1/3/95
Date

DOE Approvals: 

M.H. McFadden, CAO
Chief, Experimental Programs Branch

2/3/95
Date



E.K. Hunter, CAO
Chief, WIPP Site Branch

2/3/95
Date

CONTENTS

DEFINITION OF ACRONYMS	viii
1. INTRODUCTION	1
1.1 Purpose	1
1.2 Objectives of the Field Operations	3
2. DRILLING OPERATIONS, PROCEDURES, AND MATERIALS	6
2.1 Primary Borehole (H-19b1)	6
2.2 Tracer-Injection Boreholes	9
2.3 Equipment	13
2.3.1 Drilling Fluids	13
2.3.2 Mud Tanks	13
2.3.3 Well Casing	15
2.4 General Procedures for Coring Operations	15
2.4.1 Coring	15
2.4.2 Removal of Core from Core Barrel	16
2.4.3 Core Logging	16
2.4.4 Cleaning Core	17
2.4.5 Photographing Core	17
2.4.6 Storage and Preservation of Core	18
2.4.7 Core Photographs (Final Prints)	19
2.5 Casing Installation and Cement Grouting Procedures	19
2.5.1 Regulations	19
2.5.2 Preparations for Casing Installation	20
2.5.3 Casing Installation and Cementing	20
2.6 Surveying	21
2.7 Geophysical Logging	21
2.8 Procedures for Hydraulic Testing During Drilling	26
2.8.1 Test-Interval Selection	27
2.8.2 Test-Tool Installation	27
2.8.3 Drillstem Tests	27
2.8.4 Slug Tests	29
2.8.5 Pumping Tests	29
2.9 Depth Control	30
3. PRELIMINARY HYDRAULIC AND TRACER TESTING	32
4. DATA ACQUISITION	36
5. DATA-QUALITY OBJECTIVES	38

CONTENTS (Cont.)

6.	REGULATORY REQUIREMENTS	40
6.1	Tracer Qualification	40
6.2	Waste-Water Disposal	40
7.	QUALITY ASSURANCE	41
7.1	Quality Assurance Program Description	41
7.2	Data Integrity	42
7.3	Instrument Calibration	42
7.4	Required Reports	42
	7.4.1 Daily Drilling Log and Borehole History	42
	7.4.2 Daily Report	43
	7.4.3 Field Logbooks	43
	7.4.4 Miscellaneous Records	44
8.	SAFETY	45
8.1	Safety Requirements	45
8.2	Special Training	46
9.	REFERENCES	47

Figures

1-1.	Stratigraphic units at the WIPP site	2
1-2.	Location of H-19 hydropad with respect to other observation wells and tracer-test locations at the WIPP site	4
2-1.	Possible relative positions of the wells to be drilled at the H-19 hydropad	7
2-2.	Designed configuration of well H-19b1	10
2-3.	Designed configurations of wells H-19b2 through H-19b7	14
2-4.	Schematic illustration of the data-acquisition system (DAS)	28
3-1.	Schematic illustration of the discharge-measurement system	34

Tables

2-1.	Example form "Instructions to Logging Company"	23
2-2.	Example form "Log Quality Report"	25
5-1.	Data-quality objectives for instrumentation used in hydraulic and tracer tests	39

DEFINITION OF ACRONYMS

BGS	below ground surface
CAO	Carlsbad Area Office (of DOE)
DAS	data-acquisition system
DOE	(United States) Department of Energy
EPA	Environmental Protection Agency
ES&H	Environmental Safety and Health
FOP	Field Operations Plan
GET	General Employee Training
gpm	gallons per minute
HTC	Hydraulic-Test Coordinator
MOC	Management and Operating Contractor
MSDS	Material Safety Data Sheet
NEPA	National Environmental Policy Act
PA	Performance Assessment
PI	Principal Investigator
QA	Quality Assurance
QAP	Quality Assurance Procedure
QAPD	Quality Assurance Program Description
QC	Quality Control
SNL	Sandia National Laboratories
SOP	Safe Operating Procedure
SR	Sandia Representative
SWCF	Sandia WIPP Central Files
WIPP	Waste Isolation Pilot Plant
WID	Waste Isolation Division (of Westinghouse)
WQSP	Water Quality Sampling Program

1. INTRODUCTION

1.1 Purpose

The Waste Isolation Pilot Plant (WIPP) is a U.S. Department of Energy (DOE) research and development facility designed to demonstrate the safe disposal of transuranic wastes resulting from the United States' defense programs. The WIPP repository is excavated in the bedded halite of the Salado Formation, 2150 ft below land surface. At the WIPP site, the Salado Formation is approximately 2000 ft thick and is overlain by the approximately 300-ft-thick Rustler Formation, the 500-ft-thick Dewey Lake Red Beds, and approximately 50 ft of surficial deposits ranging from weathered sedimentary bedrock to Quaternary eolian deposits (Figure 1-1). The 24-ft-thick Culebra Dolomite Member of the Rustler Formation is the most transmissive saturated bedrock unit above the WIPP repository and is considered to be the most likely pathway for radionuclide transport to the accessible environment in the event of a breach of the repository.

Evaluation of WIPP's compliance with 40 CFR 191B by the WIPP Performance Assessment Department of SNL relies on a model of radionuclide transport through the Culebra. Modeling of transport through the Culebra requires, first, a conceptual model of the mechanisms and processes governing that transport and, second, quantitative estimates of the parameters required for numerical simulation of those processes. The Culebra Transport Program represents the combined efforts of the SNL Geohydrology (6115) and Chemical Processes (6119) Departments to provide the data necessary to construct a model for Culebra transport.

Field tracer tests are one component of the Culebra Transport Program. Tracer tests provide data with which to evaluate different processes affecting transport and to estimate transport parameters. Interpretations of previous tracer tests conducted at the WIPP site indicated that the Culebra behaves locally as a double-porosity medium in which advective flow occurs through fractures while diffusion of solutes from the fractures to the surrounding rock matrix acts to retard solute transport. Using a double-porosity transport model based on these tracer-test interpretations, the WIPP PA Department (1993) showed that physical retardation arising from

System	Series	Group	Formation	Member	Approximate Thickness* (m ft)		
Recent	Recent		Surficial Deposits		3	10	
Quaternary	Pleistocene		Mescalero Caliche		10	30	
			Gatuña				
Triassic		Dockum	Undivided		3	10	
Permian	Ochoan		Dewey Lake Red Beds		150	500	
			Rustler	Forty-niner		18	60
				Magenta Dolomite		7	24
				Tamarisk		26	85
				Culebra Dolomite		7	24
				unnamed		37	120
			Salado		600	2000	
	Castile		400	1300			
	Guadalupian	Delaware Mountain	Bell Canyon		310	1000	
			Cherry Canyon		335	1100	
			Brushy Canyon		550	1800	

* At center of WIPP site.

TRI-6115-38-1

Figure 1-1. Stratigraphic units at the WIPP site.

matrix diffusion could make the Culebra an effective barrier to release of radionuclides to the accessible environment.

This Field Operations Plan (FOP) supports the Culebra Transport Program in the investigation of the potential role of the Culebra as a transport pathway for radionuclides. The activities described in this FOP are designed to provide a group of boreholes in which to conduct tracer tests to define the nature of solute transport in the Culebra and provide quantitative estimates of all transport parameters needed for Performance Assessment calculations. The FOP describes plans, procedures, and specifications for the construction of wells at the H-19 hydropad, which is being established southeast of the WIPP surface facilities between the H-3 hydropad and observation well DOE-1 (Figure 1-2). The work will consist of drilling, coring, geophysical logging, and completing seven boreholes, H-19b1 through H-19b7, to the Culebra.

Construction of the H-19 wells will also provide site-specific geologic and geophysical data and samples of the Culebra dolomite for laboratory analysis. At H-19, one borehole, H-19b1, will be cored from about 40 ft below land surface (bottom of surface casing) to total depth and the other boreholes will be cored only through the Culebra. Compressed-air-rotary and/or water-rotary drilling methods will be used on all boreholes. The Culebra will be cored using compressed air as the circulation medium unless prevented by technical difficulties. This FOP describes the drilling methods, coring requirements, and preliminary hydraulic and tracer tests to be conducted during drilling, including equipment configurations, testing procedures, data-acquisition system (DAS), and testing requirements of the program. Detailed hydraulic and tracer testing to be performed after construction of all H-19 wells is completed will be described in Test Plans prepared for those activities.

1.2 Objectives of the Field Operations

The primary objective of the drilling program described in this field operations plan is to provide a hydropad at which to conduct field activities relevant to the Culebra Transport Program. Individual objectives to be accomplished are:

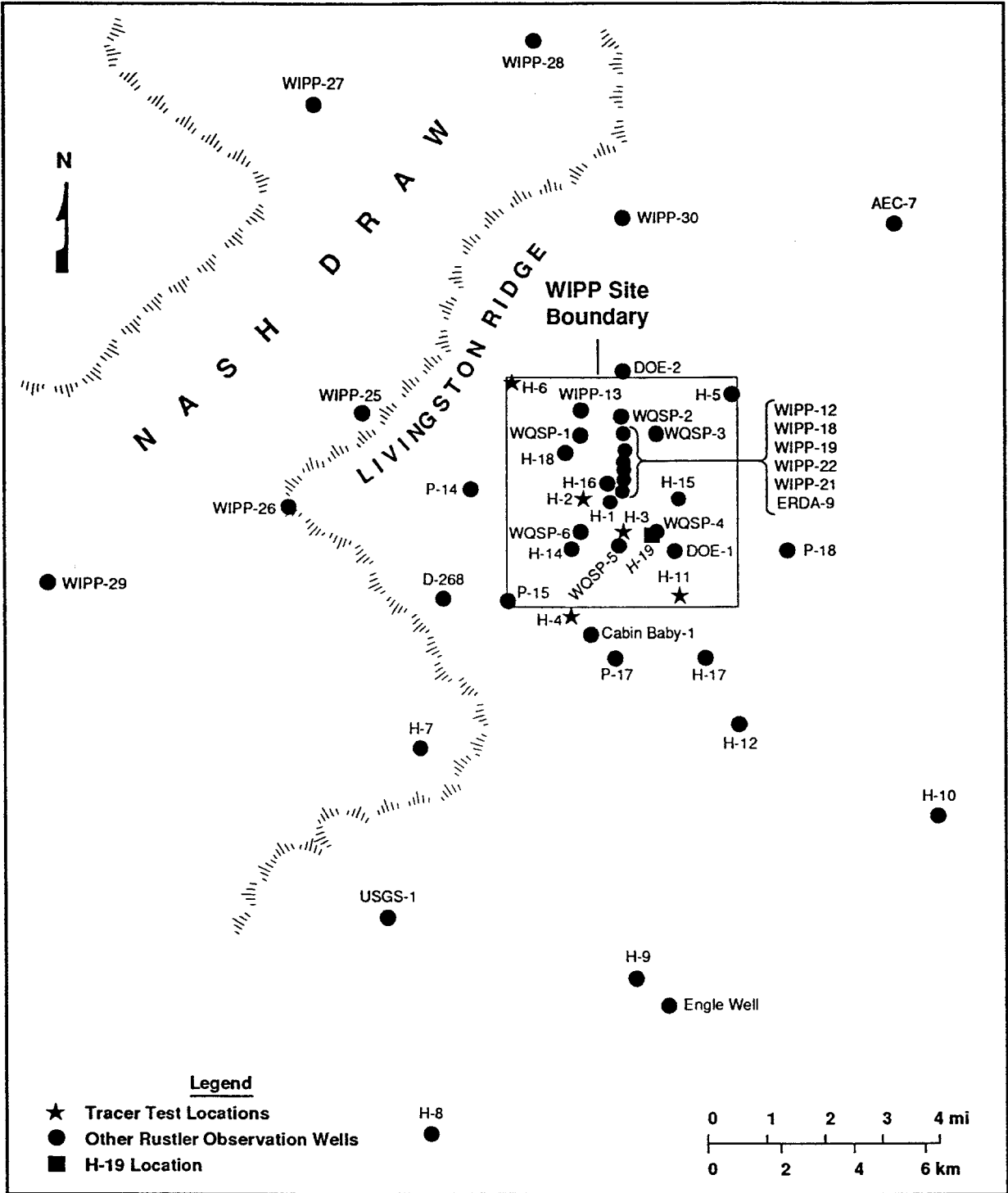

TRI-6344-665-6

Figure 1-2. Location of H-19 hydropad with respect to other observation wells and tracer-test locations at the WIPP site.

- to drill and core, from land surface to the unnamed lower member of the Rustler Formation, a primary borehole at the H-19 hydropad for tracer testing of the Culebra;
- to drill and complete six tracer-injection boreholes from land surface to the unnamed lower member of the Rustler Formation at the H-19 hydropad, including coring of the full thickness of the Culebra;
- to obtain geophysical logs, including video logs, of each of the boreholes drilled at the H-19 hydropad;
- to collect core from the Culebra, and other stratigraphic units as appropriate, for laboratory analysis of the samples' hydraulic properties; and
- to conduct hydraulic tests of selected stratigraphic horizons.

2. DRILLING OPERATIONS, PROCEDURES, AND MATERIALS

The central well on the H-19 hydropad will be called the primary borehole and will be named H-19b1. This well will be located near the center of the hydropad. Six tracer-injection wells will be drilled arranged around H-19b1 as indicated on Figure 2-1. The overall sequences of activities to be conducted are summarized below.

2.1 Primary Borehole (H-19b1)

1. Construct a 450 by 450-ft caliche pad and improve the access road to the H-19 location as appropriate and dig lined pit for the drilling rig's portable mud tanks.
2. Move in auger rig and drill a 24-inch-diameter borehole from ground surface to a depth of 40 ft at a location approximately 40 ft due north of the center of the pad. Set 20-inch outside-diameter conductor casing to 40 ft and cement annulus to ground surface.
3. Mobilize and rig-up rotary drilling rig and associated drilling equipment.
4. After the cement has set, use a nominal 9 $\frac{5}{8}$ -inch-diameter rock bit to drill out the cement plug from the bottom of the surface casing.
5. Rig up wireline coring apparatus with appropriate coring bits, core catchers, and a 10-ft-long core barrel with a split inner barrel to drill and collect PQ-size (3.34-inch) core from all units below 40 ft to approximately 10 ft above the base of the Tamarisk Member of the Rustler Formation using compressed air as a circulation medium. Any drilling-fluid additives used to control and maintain circulation must be approved by the Sandia Representative (SR) and will be documented. Core will be recovered, marked, photographed, catalogued, and stored in core boxes (see Section 2.4).
6. After coring the Magenta Dolomite Member of the Rustler Formation, drilling operations will be suspended in order to conduct a drillstem test (DST) of the entire Magenta (see

H-19 Hydropad (450 ft x 450 ft)

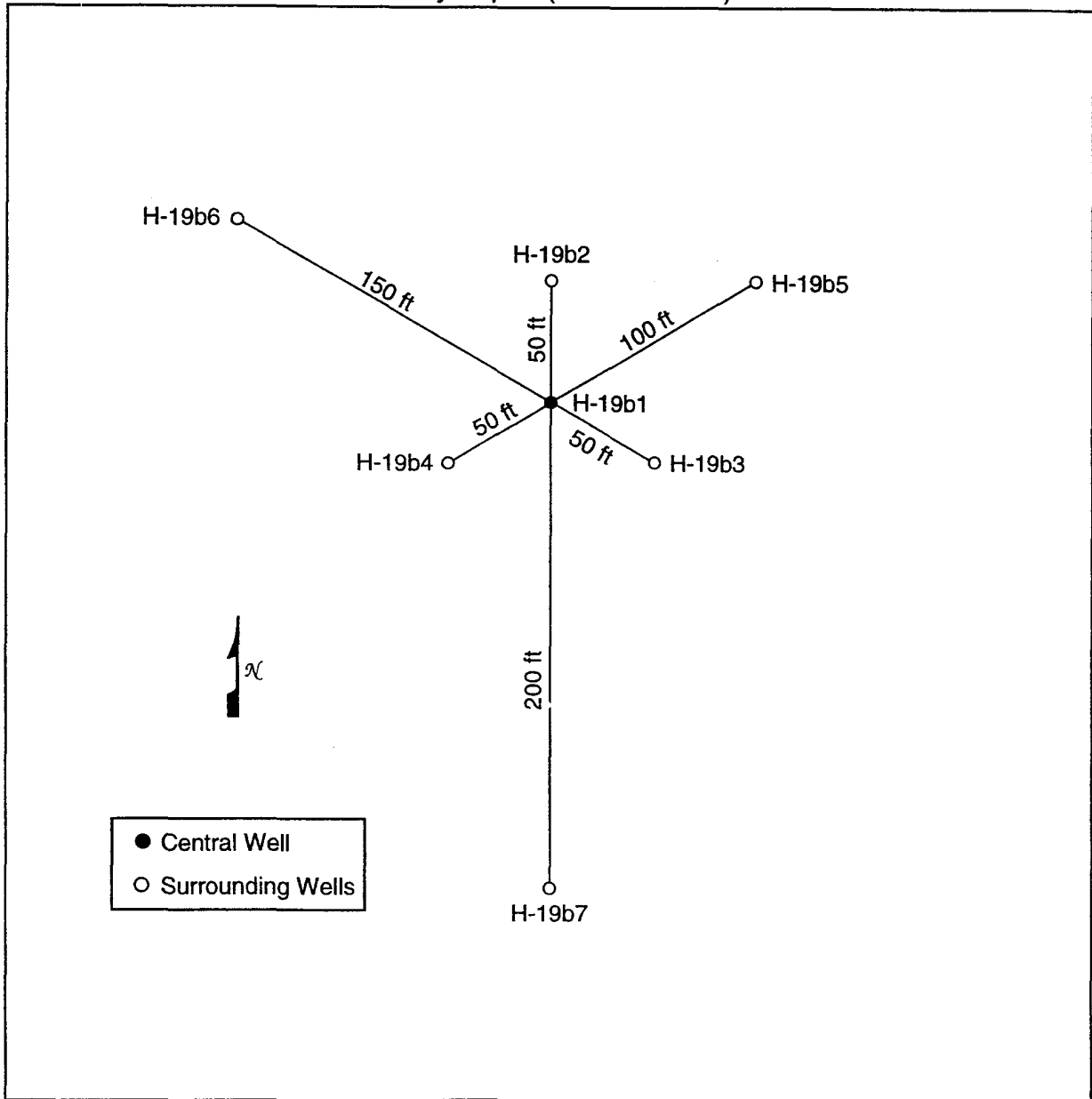

TRI-6115-36-3

Figure 2-1. Possible relative positions of the wells to be drilled at the H-19 hydropad.

Section 2.8.3). Pick up and run in single-packer DST tool, with packer set in the lower Forty-niner anhydrite. The testing of the Magenta will take approximately 48 to 96 hr. The drilling rig will be on standby status during the drillstem testing.

7. Complete coring of the Rustler Formation to a depth of approximately 748 ft below land surface, into the lower Tamarisk anhydrite and about 10 ft above its base.
8. Fill hole with brine and geophysically log the entire borehole to the lower Tamarisk Member using the caliper, neutron porosity, natural gamma, resistivity, formation microscanner, gamma-gamma density, acoustic velocity, acoustic televiewer, and/or video logs as appropriate. See Section 2.7 on geophysical logging.
9. Ream entire borehole to 14¾-inch diameter using brine as the circulation medium. Pick up, inspect for damage, and install 9.12-inch fiberglass casing to the lower part of the Tamarisk Member (approximately 748 ft). Install centralizers in selected positions to guide casing in borehole, usually 60 to 90 ft apart. See Section 2.5 regarding casing installation procedures.
10. Use a 70-30 poz-mix cement slurry mixed with halite to saturation and 2% bentonite gel to cement casing in place. Circulate a minimum of 50% excess above volume calculated to fill annulus. See Section 2.5 regarding cement grouting procedures.
11. Wait for cement to cure for 24 to 48 hours.
12. After cement has cured, pick up a nominal 7⅞-inch-diameter rock bit and drill out cement and float collar to a depth of approximately 748 ft below ground surface (BGS).
13. Pick up conventional coring assembly with bits, core catcher, and 5-ft or 10-ft core barrel with split inner barrel to collect nominal 6-inch core from the Culebra. Completely remove drilling fluid used to drill through the cement plug to allow coring of the Culebra using compressed air as a circulation medium. Continuously core from the base of the

cement plug at approximately 748 ft BGS to a depth of approximately 803 ft, a point within the unnamed lower member and about 20 ft below the Culebra. The SR will continuously monitor drilling parameters, such as penetration rate and circulation pressure, during coring and dictate the length of each core run. After coring has been completed, circulate hole to remove cuttings and other debris.

14. After native Culebra water has filled the hole up into the casing, geophysically log the remainder of the borehole to total depth using logs from the suite described in Section 2.7. Alternatively, some or all logs could be run after the completion of step 15 when the drilling rig has moved off the hole.
15. Remove all equipment from H-19b1 and install surface well protector and locking cap. Measure any casing cut off above ground surface and record measurement in daily drilling log. Sound well to confirm total depth and document sounded depth in daily drilling log (see Section 7.4.1). If cleaning/flushing of the borehole is necessary before demobilization of the drilling rig, only methods approved by the SR will be used. The drill rig will remain set up on the primary borehole until the rig is released by the SR.

The final configuration of well H-19b1 should be similar to that shown in Figure 2-2.

2.2 Tracer-Injection Boreholes

1. For boreholes H-19b2 through H-19b7, move in auger rig and drill an approximately 18-inch-diameter borehole from ground surface to approximately 40 ft. Set 14-inch outside-diameter conductor casing and cement annulus to ground surface. H-19b2 will be located due north of H-19b1, approximately 50 ft away. H-19b3 and H-19b4 will be located the same distance from H-19b1 as H-19b2, but along azimuths of S60°E (120°) and S60°W (240°), respectively, as shown in Figure 2-1. The final locations of H-19b5, H-19b6, and H-19b7 will be determined as discussed below in Section 3.
2. Mobilize and rig-up rotary drilling rig and associated drilling equipment.

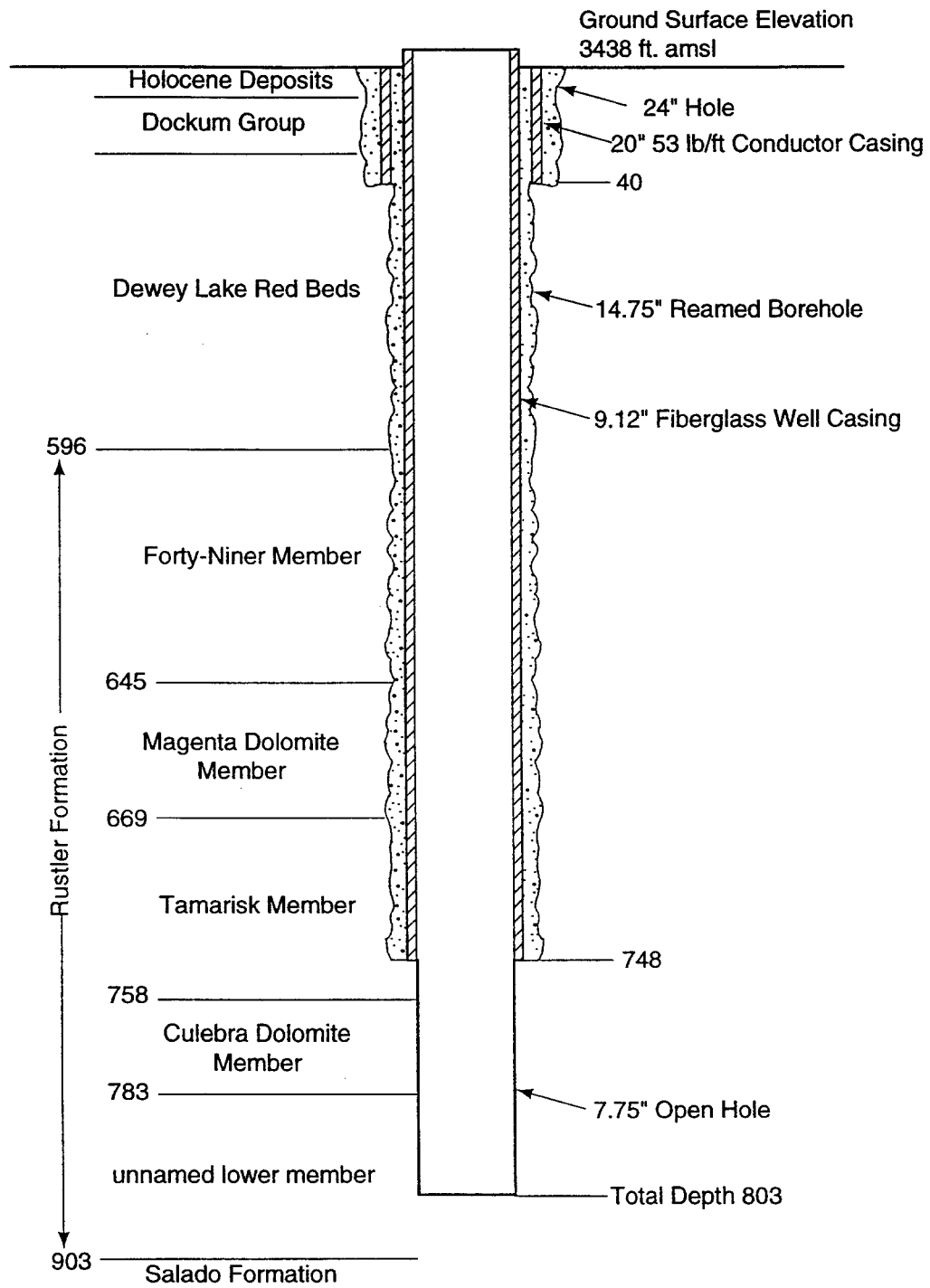

Note: Depths in feet approximate
Not to Scale

Date: 01/05/94
Ref: JBP/Bhole18/85

TRI-6115-6-3

Figure 2-2. Designed configuration of well H-19b1.

3. Rig up and run-in-hole with 9⁵/₈-inch nominal rock bit. Drill out the cement plug from the bottom of the surface casing and continue to a depth of approximately 748 ft below land surface in the lower Tamarisk Member of the Rustler Formation, about 10 ft above the Culebra, using brine as the circulation medium. Document any drilling-fluid additives used to aid in cuttings removal or borehole stabilization. Circulate the hole.
4. Geophysically log borehole to the lower Tamarisk Member using the caliper, neutron porosity, natural gamma, resistivity, gamma-gamma density, acoustic velocity, formation microscanner, acoustic televiewer, and/or video logs as appropriate. Alternatively, if only gamma and neutron logs are desired of the portion of the borehole to be cased, they could be run through the casing at the same time as the logs described in step 10 are performed. See Section 2.7 on geophysical logging.
5. Ream entire borehole to 10³/₄-inch diameter. Pick up, inspect, and install 7-inch fiberglass casing to the lower part of the Tamarisk Member (approximately 748 ft). Install centralizers in optimum position to guide casing in borehole, usually 60 to 90 feet apart. See Section 2.5 regarding casing installation procedures.
6. Use a 70-30 poz-mix cement slurry mixed with halite to saturation and 2% bentonite gel to cement casing in place. Circulate a minimum of 50% excess above volume calculated to fill annulus between the casing and the borehole. See Section 2.5 regarding cement grouting procedures.
7. Wait for cement to cure for 24 to 48 hours.
8. After cement has cured, pick up a nominal 6¹/₈-inch-diameter rock bit and drill out cement and float collar to a depth of approximately 748 ft BGS.
9. Pick up wireline coring assembly with bits, core catcher, and 5-ft-long split-tube inner barrel to collect nominal 3.34-inch-diameter core from the Culebra. Completely remove any drilling fluid used to drill through the cement plug to allow coring of the Culebra

using compressed air as a circulation medium. If necessary, use Culebra water pumped from well H-19b1 as drilling fluid to core the Culebra. Continuously core from the base of the cement plug at approximately 748 ft BGS to a depth of approximately 803 ft, a point within the unnamed lower member and about 20 feet below the Culebra. The SR will continuously monitor drilling parameters, such as penetration rate and circulation pressure, during coring and dictate the length of each core run. After coring has been completed, circulate hole to remove cuttings and other debris.

10. After Culebra water level has risen into casing, geophysically log the remainder of the borehole to total depth using logs from the suite described in Section 2.7. (If necessary to accommodate logging tools, ream interval below casing to 6 $\frac{1}{8}$ inches using Culebra water from H-19b1 as the circulation medium.) Alternatively, some or all logs could be run after the completion of step 12 when the drilling rig has moved off the hole.
11. Drillstem and/or slug testing of part or all of the Culebra and/or of the upper part of the unnamed lower member is not planned in each of the boreholes as it is drilled. However, if requested by the Hydraulic-Test Coordinator (HTC; the Principal Investigator (PI) or his designee) for a particular borehole, conduct a DST or slug test of the Culebra and/or unnamed lower member. Pick up and run in hydraulic-testing equipment. For a test of the Culebra, set packer in the lower Tamarisk anhydrite or the bottom of the casing, whichever appears to provide the best testing location as directed by the HTC. A double-packer test tool could be used if borehole conditions are appropriate. For any test of the unnamed lower member, a straddle-packer assembly will be used, with the upper packer set in the lower Tamarisk anhydrite and the lower packer set at the base of the Culebra. The test will be conducted in the hole below the lower packer, while monitoring for pressure response in the Culebra. The testing of the Culebra or unnamed lower member will take approximately 48 to 96 hours. The drilling rig will be on standby status during hydraulic-testing operations.
12. Remove all equipment from borehole and install surface well protector and locking cap. Measure any casing cut off above ground surface and record measurement in daily drilling

log. Sound well to confirm total depth and document in daily drilling log. If cleaning/flushing of the borehole is necessary before demobilization of the drilling rig, only methods approved by the SR will be used. The drill rig will remain set up on the borehole until the rig is released by the SR.

The final configurations of wells H-19b2 through H-19b7 should be similar to that shown in Figure 2-3.

2.3 Equipment

2.3.1 Drilling Fluids

- A. The use of any drilling fluid must be approved by the SR and consist only of water, brine, or air from a source specified by the the drilling contractor and approved by the SR.
- B. No organic additives to the drilling fluid will be permitted without permission from the SR. Brine-based drilling fluid may be used to protect the soluble formations that may be encountered during the drilling operations. However, only air or Culebra water can be used when drilling or coring through or below the Culebra.
- C. Contractor-recommended and SR-approved drill-pipe lubricating material may be used in drilling operations to the casing point. Only teflon or other-SNL-approved drilling-pipe lubricant may be used in coring and drilling the Culebra or the unnamed lower member. Other lubricating materials may be used only after approval by the SR.
- D. Casing will be installed using only teflon or other SNL-approved lubricants.

2.3.2 Mud Tanks

The drilling contractor will provide clean portable tanks, with certification of cleaning, for drilling fluids used for coring and reaming the Culebra and unnamed lower member. The SR will

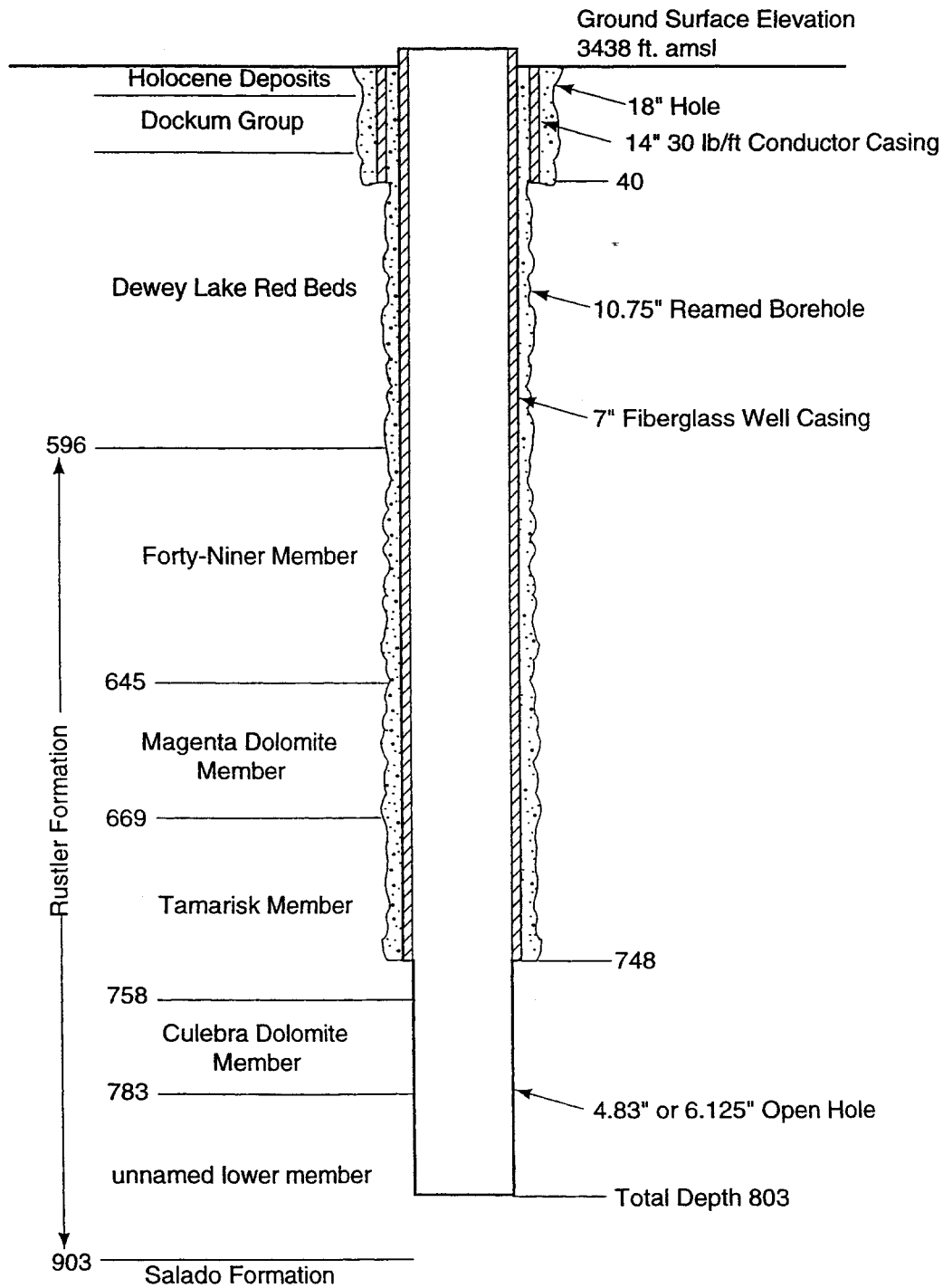

Note: Depths in feet approximate
Not to Scale

Date: 01/05/94
Ref: JBP/Bhole18/85

TRI-6115-6-2

Figure 2-3. Designed configurations of wells H-19b2 through H-19b7.

inspect the tanks before use to determine that they are free of holes and cracks, and will document this inspection in his daily drilling log. All drilling-fluid waste will be contained on-site in portable tanks and disposed of by an SNL contractor at a licensed disposal facility (see Section 6.2).

2.3.3 Well Casing

The well casing for this program will be Centron® fiberglass/epoxy integral joint casing. The casing for H-19b1 will have an outside diameter of 9.12 inches, an inside drift diameter of 8.41 inches, and a weight of 8.70 lb/ft. The casing for the other six wells will have an outside diameter of 7.00 inches, an inside drift diameter of 6.38 inches, and a weight of 5.70 lb/ft.

2.4 General Procedures for Coring Operations

Drilling and coring operations will be performed as part of the installation of seven boreholes at the H-19 hydropad, which is to be constructed between well DOE-1 and the H-3 hydropad. Coring operations will consist of wireline coring to obtain an estimated 708 feet of 3.34-inch-diameter (PQ) core from the Dewey Lake Red Beds through the Tamarisk Member of the Rustler Formation in borehole H-19b1, conventional coring to obtain approximately 55 feet of 6-inch-diameter core from the Culebra and the unnamed lower member of the Rustler at borehole H-19b1, and wireline coring to obtain approximately 330 ft (total) of 3.34-inch-diameter core from the lower Tamarisk, Culebra, and unnamed lower member of the Rustler at boreholes H-19b2 through H-19b7. Both conventional and wireline core barrels will include split inner barrels to enhance core recovery and minimize disturbance during core removal. Core will be removed from the core barrel, logged, measured, cleaned, marked, photographed, packaged, transported, and stored according to the following procedures.

2.4.1 Coring

Both wireline and conventional coring operations will be conducted to produce 3.34-inch (PQ) and 6-inch-diameter core, as required. Other equipment and material such as drill collars

and stabilizers, drilling fluid (compressed air, air-foam, or brine), and drilling techniques such as use of drilling weight, rotary speed, and fluid-circulation rates will be utilized so as to obtain the best possible core recovery according to the best judgment of the SR. The SR will be in control of operations at all times that coring is in progress.

The site geologist shall maintain a field logbook (see Section 7.4.3) showing dates and times of all core runs, beginning and ending depths of all core runs (established as outlined in Section 2.9), core recovery percentage from each run, and such variations in penetration rate as might be observed. The field logbook shall also include a core-photography log listing all photographs taken and associated depths (see Section 2.4.5), as well as a summary of how the core is boxed. Copies of all logbooks and daily records will be kept on site throughout the drilling and coring operations.

2.4.2 Removal of Core from Core Barrel

Core should be removed from the split inner core barrel as gently as possible, under the supervision of the site geologist, to cause minimum disturbance to the order and condition of the core. As the core is removed, it will be placed in troughs in the order that it is retrieved from the core barrel. Troughs will be marked with red at the top end and black at the bottom indicating down direction of the core.

2.4.3 Core Logging

The site geologist will log the core at the time of collection using SNL WIPP Form Number 393: General Purpose Core-Log Inventory. The core pieces shall be matched together as snugly as possible and a double line shall be drawn down the length of the core using indelible red and black markers. The markers shall be taped together to make parallel lines, with the black line on the right as viewed looking in the downward direction along the core. Each core piece should be measured and marked indicating depth at a minimum of each foot with footage expressed to the closest 0.1 ft. The reference datum for depth will be ground surface. All logging forms will indicate the distance from ground surface to the Kelly bushing on the rotary

table of the drill rig. Pieces too small or too rough to be individually marked will be bagged and the bags will be marked with the appropriate depths. Any lost core should be logged at the bottom of each cored interval unless known to be otherwise and so explained on the core log. Core loss should be indicated in the core-storage boxes using a block of wood (e.g., 2x2-inch stock) with the estimated core-loss interval marked with visible waterproof ink.

A detailed geologic description of the core shall be recorded on the core logging form. Lithologic, sedimentologic, and mineralogic variations shall be noted, with depths referenced to at least the nearest 0.1 ft. The color of each interval described shall be determined using a Munsell color chart and noted in the log. All visible fractures shall be logged at the depth of the midpoint of the fracture, and the dip angle and fracture filling or staining (if any) shall be noted. At this time, no closed features, such as cemented fractures, shall be opened by the site geologist or other field person. Such features shall be preserved for later deliberate study of delicate mineral or structural features, including measurement of fracture apertures.

2.4.4 Cleaning Core

Core will be wiped or brushed to remove any soft mud cake and/or excess mud or cuttings as soon as possible following removal of the core from the core barrel. A rag dampened in drilling fluid or Culebra water will be used to wipe the core. If core is washed with other fluids, this occurrence will be noted in the field logbook, stating the type of fluid, the intervals so exposed, and the time of the occurrence.

2.4.5 Photographing Core

All core shall be photographed in color twice: once before the core is removed from the split inner core barrel and again after it has been transferred to troughs or boxes. The first photography will be performed immediately after the two halves of the split inner barrel have been separated, while the core rests in half of the barrel. A tape measure demarcated in tenths and hundredths of feet shall be laid alongside the core for the photographs, with the zero point on the tape measure being at the top of the core run. The field of view for each photograph

should extend no more than three feet, with at least six inches of overlap between consecutive photos. Each photograph taken shall include a title block or board showing well number, date, core-run number, and down direction. These photographs will provide a record of the core order that might be used to reorder any core that becomes accidentally displaced during transfer to troughs or during logging.

After the core has been logged, labeled, and cleaned, it will be carefully moved to the core trailer and prepared for more detailed color photography. The core may be positioned either in troughs or core boxes, being sure that the ends of each core interval are properly marked on wood spacers and all missing-interval spacers are correctly marked and included in the appropriate locations. The camera shall be mounted in a rack above the core to maintain a consistent distance from the core and a consistent field of view. The field of view for each photograph should extend no more than three feet, with at least six inches of overlap between consecutive photos. Core may be wetted with drilling fluid to enhance the quality of the photography. Core should be rotated by the site geologist or SR to enhance the visibility of pertinent features such as fractures, bedding planes, color, or any other significant lithologic characteristics. Each photograph taken shall have a title block or board showing well number, date, core interval (accurate within overlap with other photos), core-run number(s), core-box number (if boxed), and down direction, as well as color and length scales.

2.4.6 Storage and Preservation of Core

After the core has been photographed, it will be boxed for storage in the WIPP-site core library. The core boxes shall be labeled in sequence with well number, date, core-run number, and depths of the core pieces in each box. Breaking the core to fit it into boxes should be minimized to the extent possible. All artificial breaks shall be noted in the core log and shall also be indicated on the core itself using an indelible marker. All core shall be placed in clear plastic sleeves with heat-sealed ends inside the core boxes. After completion of coring in each hole, an inventory and chain-of-custody sheet will be prepared detailing the contents of each core box, and the core boxes and inventory sheet will be transmitted to the WID core library, where

the core will be logged in by the WID core-library custodian. All core must be protected from freezing between the time it is collected and when it is transferred to the core library.

2.4.7 Core Photographs (Final Prints)

The detailed core photographs (the second set discussed in Section 2.4.5) will be distributed as 8½ by 11-inch color prints as follows:

- 4 sets: SNL Department 6115, MS1324, ABQ, Attn. R.L. Beauheim, L.C. Meigs, P.B. Davies, R.M. Holt
- 2 sets: SNL Department 6352, MS1330, ABQ, Attn. SWCF (with negatives)
- 2 sets: WID Project Office, Carlsbad, NM
- 1 set: SNL Department 9333, MS1156, ABQ, Attn. J.W. Mercer
- 1 set: INTERA Inc., WIPP site, Attn. W.A. Stensrud
- 1 set: INTERA Inc., ABQ, Attn. M.B. Kloska
- 1 set: WIPP Core Library, WIPP site
- 1 set: WTAC, Carlsbad, NM

2.5 Casing Installation and Cement Grouting Procedures

Fiberglass casing will be installed in each borehole and the annular space between the casing and the borehole will be filled with cement grout under the direction of the SR. Complete filling of the annular space will be demonstrated by surface return of the grout mixture from the annular space. The drilling contractor will allow at least 24 to 48 hours for casing cement to set before resuming drilling/coring operations.

2.5.1 Regulations

All casing and cementing operations will observe regulations issued by the New Mexico State Engineer for casing wells through known aquifers. The State Engineer's office will be notified in advance of casing and cementing operations.

2.5.2 Preparations for Casing Installation

Ream and/or condition the boreholes using brine as the circulation medium, if necessary to remove tight places. Run a caliper log, if necessary, to calculate the proper amount of cement and to aid with the selection of appropriate positions for centralizers (i.e., avoiding washout zones), typically 60 to 90 ft apart.

The SR will inspect the body and threads of the casing for damage, discarding damaged sections, and document the inspection in his daily drilling log. Install combination float collar and guide shoe. Measure dimensions of float collar and guide shoe, photograph, and sketch connection to casing in daily drilling log. Number and measure (tally) all sections of casing to be used, recording tally in daily drilling log.

2.5.3 Casing Installation and Cementing

Run in the casing to the preselected casing point near the base of the Tamarisk Member, installing centralizers at the selected positions as the casing advances. For grout mixture, use a 70-30 poz-mix cement slurry mixed with sodium-chloride to saturation and 2% bentonite gel.

Install an appropriate cementing head and connect to the mixing and pumping units. Begin circulation with chemical wash followed by an appropriate fluid spacer, followed by an appropriate volume of RFC-thixotropic cement slurry, followed by 70-30 poz cement slurry to equal at least 150% of the calculated annulus volume between the borehole and the casing. Continue pumping at about 2½ barrels per minute (100 gpm) until cement-slurry returns acceptable to the SR are observed to issue from the borehole-casing annulus at ground surface. Displace the top plug with water and then bump plug with about 500 psi (maximum of 1000 psi) over displacing pressure. Check the float collar and, if it is holding, close in the cementing head and *wait for cement to cure for 24 to 48 hours*, as dictated by the SR. Maintain tension on the casing string while cement is setting.

2.6 Surveying

Surface locations and elevations of the wells will be surveyed by a registered professional land surveyor after the wells are completed. This surveying will be performed in two stages. The first four wells (H-19b1 through H-19b4) will be surveyed after H-19b4 is completed. The last three wells will be surveyed after H-19b7 is completed. Deviation surveys will be performed by a logging contractor during the geophysical logging discussed in Section 2.7 to determine the vertical alignment of casing/boreholes and the true positions of the boreholes in the Culebra relative to the surface locations.

2.7 Geophysical Logging

Borehole H-19b1 will be geophysically logged by the U.S. Geological Survey and/or other SNL contractor before casing is set. The borehole interval below the casing will be logged after drilling is completed. Boreholes H-19b2 through H-19b7 will be logged after casing is set and the wells are completed. (Note that logging through casing precludes the use of electric logs.) Logging will be completed in wells H-19b1 through H-19b4 before drilling begins on H-19b5. Logging of H-19b5, H-19b6, and H-19b7 may be performed either after each individual well is completed, or after all three wells have been completed. The suite of geophysical logs from which individual logs will be selected by the SR for each interval to be logged includes:

- Natural gamma
- Neutron porosity
- Gamma - gamma density
- Resistivity (laterolog)
- Formation microscanner
- Caliper
- Acoustic velocity
- Fluid electrical conductivity (hydrophysical)
- Acoustic televiewer (oriented)
- Video (oriented)

Before running any logs, the SR will prepare the form "Instructions to Logging Company" shown in Table 2-1 for the specific logs to be run. Before logging, the SR will meet with the logging company's engineer. The SR will present the "Instructions to Logging Company" and discuss: 1) the entire logging program and special requirements; 2) hole conditions that may cause problems; and 3) zones of special interest. The SR will also discuss and request the following be done:

- The equipment will be warmed up for the amount of time recommended by the manufacturer and tools will be checked to see that they are calibrated as appropriate and functioning properly upon arrival at the location.
- R_m , R_{mf} , and R_{mc} will be measured on mud sample if electrical logs are to be run. The logging company should run the sample through a mud press.
- All sidewall and compensated neutron logs and all density porosity curves will be run on limestone matrix over the zones of interest, regardless of the lithology.
- Equipment will be tested while running in hole.
- Depths for all logs will be "zeroed" at a point designated by the SR as each tool enters the hole and checked as it comes out, as discussed in Section 2.9.
- Before-and-after log calibrations will be shown for all curves.
- Panel calibrations will be shown for all density and neutron logs; integration checks will be shown for all integrated acoustic logs.
- In addition to caliper rings, the caliper calibration should show "tool full open" and casing readings.
- A minimum 200 ft (or interval logged) repeat must be shown for each hole.
- Overlap previous runs by at least 200 ft, if possible.
- All headings information on logs will be completely filled out.
- All open-hole logs shall be digitized and recorded on magnetic tape or disk.

The SR will be present and observe the logging operation to the extent necessary to assure that the instructions have been followed. He will complete a "Log Quality Report" (shown in Table 2-2) following the operation. All applicable boxes on the Log Quality Report must be checked "yes" before the SR will accept the final logs.

SANDIA NATIONAL LABORATORIES
INSTRUCTIONS TO LOGGING COMPANY

Date _____ Logging Company _____
 Prepared By _____ Logging Engineer _____
 Witnessed By _____

Log Headings:

Company _____
 Well Number _____
 Field _____
 County _____ State _____
 Location _____
 Section _____ Township _____ Range _____
Permanent Datum: ground level (G.L.) Elevations: G.L. _____
 drill floor (D.F.) D.F. _____
 Kelly bushing (K.B.) K.B. _____

Hole Status

	<u>SIZE</u>	<u>FROM</u>	<u>TO</u>		<u>SIZE</u>	<u>FROM</u>	<u>TO</u>
Casings	_____	_____	_____	Borehole	_____	_____	_____
	_____	_____	_____		_____	_____	_____
	_____	_____	_____		_____	_____	_____

Fluid Status

Type Fluid in Borehole _____ Fluid Level _____ Fluid Loss _____
 Density _____ pH _____ Viscosity _____

Purpose of Logging Program, Zones of Special Interest, Critical Hole Conditions,
 Remarks, Etc. _____

Number of Prints: Field _____ Final _____

Send to: Sandia National Laboratories
 P.O. Box 5800, MS 1156, Attn. Jerry W. Mercer
 Albuquerque, New Mexico 87185-1156

Table 2-1. Example form "Instructions to Logging Company".

Log Number* _____ Log Type _____

(a.) Vertical Depth Scales 2 inches/100 feet and 5 inches/100 feet

(b.) Horizontal Logging Scales _____

(c.) Logging Speed Desired _____

(d.) Interval to be Logged _____

(e.) Zones of Special Interest _____

(f.) Special Instructions _____

Log Number* _____ Log Type _____

(a.) Vertical Depth Scales 2 inches/100 feet and 5 inches/100 feet

(b.) Horizontal Logging Scales _____

(c.) Logging Speed Desired _____

(d.) Interval to be Logged _____

(e.) Zones of Special Interest _____

(f.) Special Instructions _____

Log Number* _____ Log Type _____

(a.) Vertical Depth Scales 2 inches/100 feet and 5 inches/100 feet

(b.) Horizontal Logging Scales _____

(c.) Logging Speed Desired _____

(d.) Interval to be Logged _____

(e.) Zones of Special Interest _____

(f.) Special Instructions _____

* Logs do not need to be run in this sequence

Table 2-1 continued. Example form "Instructions to Logging Company".

Fourteen final copies of the logs shall be prepared and distributed as follows:

- 3 sets: SNL Department 6115, MS1324, ABQ, Attn. R.L. Beauheim, L.C. Meigs, P.B. Davies
- 2 sets: SNL Department 6352, MS1330, ABQ, Attn. SWCF
- 2 sets: SNL Department 9333, MS1156, ABQ, Attn. J.W. Mercer
- 1 set: USGS, Water Resources, ABQ, Attn. R.K. Deweiss
- 2 sets: WID Project Office, Carlsbad, NM
- 1 set: NM State Engineer, Roswell, NM
- 1 set: INTERA Inc., WIPP site, Attn. W.A. Stensrud
- 1 set: INTERA Inc., ABQ, Attn. M.B. Kloska
- 1 set: WTAC, Carlsbad, NM

The logging company shall provide two copies of magnetic tapes or disks containing the digitized log data, labelled as described in Quality Assurance Procedure (QAP) 17-1: WIPP Quality Assurance Records Source Requirements. The disks or tapes shall be submitted to the Sandia WIPP Central Files (SWCF) along with the other documentation required by QAP 17-1.

2.8 Procedures for Hydraulic Testing During Drilling

Hydraulic testing at the H-19 hydropad will be performed under the technical direction of the HTC. At the discretion of the SR or HTC, drilling may be halted at any time to allow the performance of hydraulic tests. The tests will be used to obtain estimates of the transmissivity and hydraulic head of selected intervals in the Dewey Lake Red Beds and/or Rustler Formation. The hydraulic tests could take the form of drillstem tests, slug-withdrawal tests, and/or pumping tests, depending on hydraulic conditions. In general, a pumping test will not be performed on a unit incapable of yielding at least one gallon per minute (gpm). Each test is anticipated to take a minimum of 12 hours and a maximum of 96 hours. The duration of each test will depend on the quality and amount of data required to achieve test objectives. Appropriate equipment calibration will be conducted before each test and recorded in the field logbook for hydraulic and tracer testing (see Section 7.3.4) and on appropriate forms in accordance with QAP 12-1: Calibration and Control of Measuring and Test Equipment. Complete documentation of the test equipment, procedures, installation configuration, manually

performed measurements, and sequence of events will be kept in the field logbook for hydraulic and tracer testing.

The drilling contractor or other SNL contractor will set packers, pumps, and/or other test equipment provided by SNL at depths in well(s) designated by the HTC and remove the equipment from the well(s) upon completion of testing. The objective of the following procedures is to establish consistent hydrologic-testing methods and techniques in order to obtain reliable data in a uniform manner. All fluids produced during swabbing or pumping tests will be stored on-site in steam-cleaned tanks until it can be disposed of off-site under the requirements outlined in Section 6.2.

2.8.1 Test-Interval Selection

Information obtained from logging and coring of the wells at the H-19 hydropad will be used by the HTC to identify the intervals to be tested. The HTC will document his decisions, and the information upon which they are based, in the field logbook for hydraulic and tracer testing.

2.8.2 Test-Tool Installation

After the selected test intervals have been cored and identified, install testing equipment using an appropriate inflatable packer (or packers) attached to 2³/₈-inch tubing. The equipment will include transmitters (and possibly thermocouples) capable of measuring the pressures (and temperatures) above and within the test interval. The pressure (and temperature) data will be monitored and recorded using a computer-controlled DAS (Figure 2-4) in accordance with WIPP Procedure 509: Operation of PERM DAS Program. Real-time plots and preliminary analysis of the data will be used by the HTC to adjust the testing schedule as necessary.

2.8.3 Drillstem Tests

All drillstem tests performed will be conducted in accordance with WIPP Procedure 515: Slug and Drillstem Testing, which is summarized here. Assemble the DST tool, which includes a packer, a downhole shut-in tool, and three pressure transmitters, and install downhole. Inflate

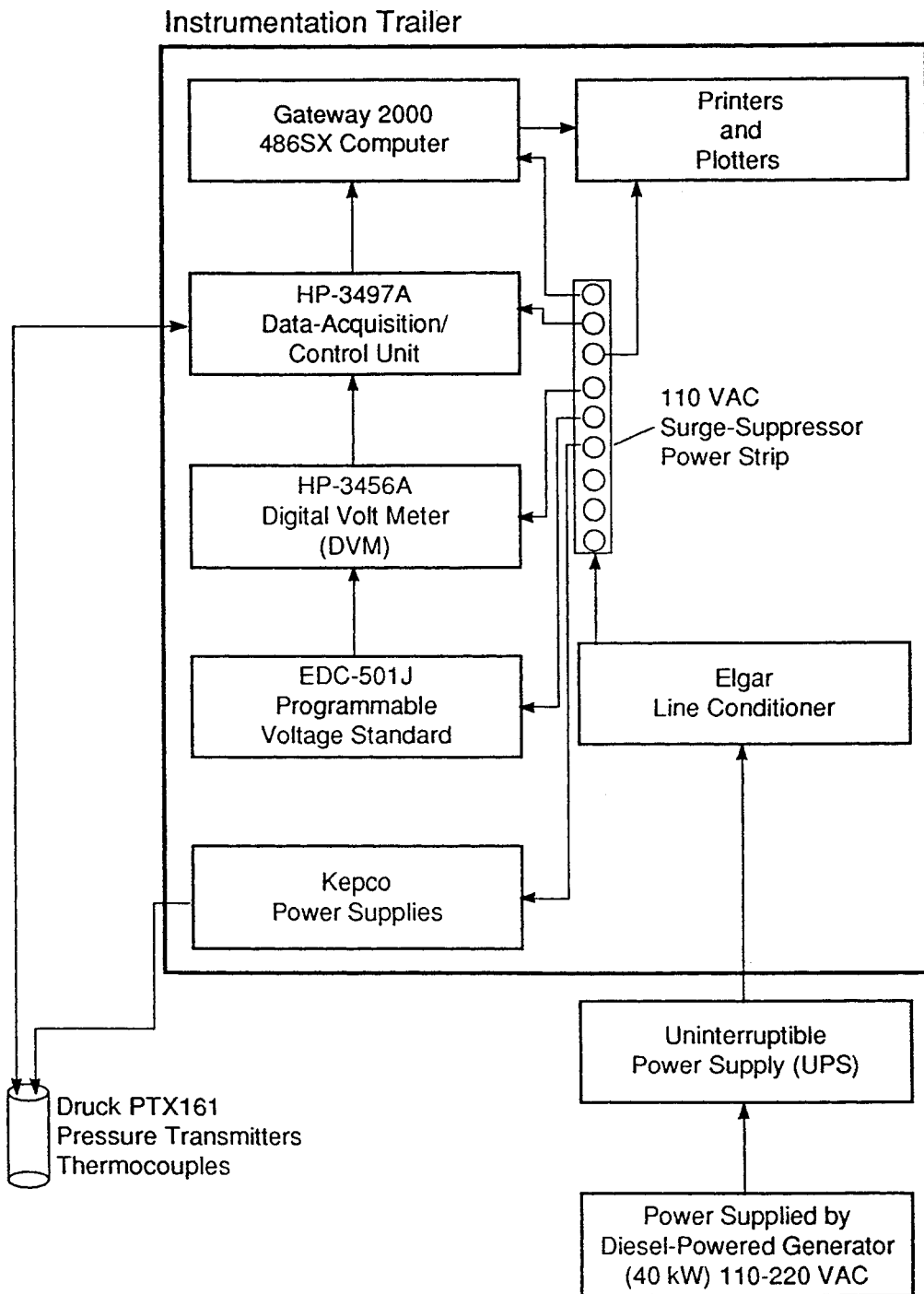

TRI-6115-35-1

Figure 2-4. Schematic illustration of the data-acquisition system (DAS).

the packer, close the shut-in tool, and allow the formation pressure below the packer to stabilize. Swab water from tubing above shut-in tool and measure the specific gravity of this water following WIPP Procedure 513: Measurements of Specific Gravity, Conductance, pH, and Temperature. Open shut-in tool for flow period. Close shut-in tool for buildup period when directed by the HTC. The shortest time schedule for flow and buildup periods will be determined by the HTC based on the real-time evaluation of the formation's pressure response. A minimum of two sequences of flow and buildup periods will be required.

2.8.4 Slug Tests

Any slug test performed will be conducted in accordance with WIPP Procedure 515: Slug and Drillstem Testing, which is summarized here. Assemble and install the DST tool described in Section 2.8.3. Inflate the packer, close the shut-in tool, and allow the formation pressure below the packer to stabilize. Swab water from tubing above shut-in tool and measure the specific gravity of this water following WIPP Procedure 513: Measurements of Specific Gravity, Conductance, pH, and Temperature. Open shut-in tool to initiate slug test. The increase in pressure versus time as water flows into the tubing is monitored with the downhole pressure transmitters and recorded by the DAS. Real-time analysis of the pressure recovery will be used by the HTC to establish the time when the test will be terminated or when the test interval may be shut-in to obtain additional data. Testing time may vary from hours to days depending on the formation's transmissivity.

2.8.5 Pumping Tests

Pumping tests of the Culebra will be performed in each of the H-19 wells, and may also be used to evaluate the hydraulic properties of any other unit capable of producing at least one gpm. All pumping tests performed will be conducted in accordance with WIPP Procedure 505: Pumping Tests. General procedures are outlined here. To conduct a pumping test of a confined water-bearing unit, a pump will be lowered into the well on either tubing or pipe to a distance about 10 ft above the unit. A packer may or may not be set above the pump at the discretion of the HTC. If a pumping test is to be performed of a unit under water-table conditions, the HTC will determine the location at which to set the pump. To determine the pumping rate to be used during the test, the pump will be operated at successively higher rates for a few hours

and the HTC will evaluate the maximum rate that could be sustained for three days without dewatering the well. After allowing the water level in the well to recover and stabilize, the pumping test will be performed at 75 to 80% of the maximum sustainable rate. Pressure drawdown and recovery during the test will be monitored with downhole pressure transmitters and recorded by the DAS. Real-time analysis of the pressure data will be used by the HTC to establish the time when the pump will be turned off and the time at which recovery monitoring will be terminated. Testing time may vary from one to several days depending on the formation's transmissivity.

If desired by the WID Water Quality Sampling Program (WQSP), WID will collect water samples for laboratory analysis before pumping is terminated. Before terminating pumping at H-19b2, H-19b3, and H-19b4, at least 200 gallons of Culebra water will be collected from each well in clean containers for use in the later preliminary tracer test.

2.9 Depth Control

Drilling, coring, casing installation, geophysical logging, and hydraulic testing all require accurate knowledge of depth in the borehole. For each borehole, all depths shall be referenced to a fixed primary datum that will not be subject to change during the different types of operations performed. This datum shall be a marked point on the upper rim of the surface casing for each borehole, unless the SR designates an alternative point. The datum shall be marked on the surface casing with an indelible marker, and its elevation shall be surveyed after the well is completed, as discussed in Section 2.6. A secondary datum, such as a fixed point on the drilling floor, may be used to help establish depth during specific operations. The SR (or HTC, as appropriate) will document the selection of this secondary datum and the methods used to measure its elevation with respect to the primary datum in his daily drilling log (or field logbook).

Depths with respect to either the primary datum or a secondary datum will be established by measuring (tallying) the lengths of all sections of drill pipe, tubing, casing, and other equipment lowered into the hole using an engineer's tape graduated in 0.01-ft increments, and measuring the portion remaining above the datum (the "stickup") when the equipment is in its desired position. All tallies and other measurements shall be recorded in the SR's daily drilling

log and/or the site geologist's or HTC's field logbook (see Section 7.4), as appropriate. All measurements and their recording shall be checked by a second individual and both individuals will initial the recorded measurements in the log. Photographs shall be taken of all equipment (e.g., drill bits, core barrels, packers, pumps, etc.) attached to tubular goods (pipe, tubing, and casing), with a scale included in each photograph. Sketches of all equipment, with dimensions indicated, shall also be included in the daily drilling log and/or field logbooks.

For geophysical logging, the SR shall, in cooperation with the logging contractor, identify the sensing point on each tool and verify that the depth on the logger's depth counter is correctly "zeroed" when the sensing point is at either the primary or secondary datum. The "zero" depth reading shall be checked by the SR when the logging tool returns to the surface. These readings shall be documented in the SR's daily drilling log. The SR shall also draw a sketch in his daily drilling log of each logging tool, indicating dimensions and the location of each sensing point.

3. PRELIMINARY HYDRAULIC AND TRACER TESTING

Figure 2-1 indicates the intended pattern of the locations of boreholes H-19b2 through H-19b7 with respect to H-19b1. However, the exact positions of H-19b5, H-19b6, and H-19b7 will be determined after H-19b1, H-19b2, H-19b3, and H-19b4 have been completed. Drilling will be temporarily suspended following completion of H-19b4 so that preliminary hydraulic and tracer testing can be conducted in order to obtain preliminary estimates of the Culebra's hydraulic properties and to determine the approximate direction of the highest groundwater velocity. This information will be used to determine optimum locations for H-19b5, H-19b6, and H-19b7.

The preliminary hydraulic testing will be conducted in several stages. Pressure transmitters/transducers (calibrated and controlled per QAP 12-1: Calibration and Control of Measuring and Test Equipment) will be installed in each well after it has been completed to monitor responses to drilling and testing in subsequent wells. A computer-controlled DAS will be used to monitor and record the pressure data following WIPP Procedure 509: Operation of PERM DAS Program. After each of the wells has been completed, a pumping exercise will be conducted to both develop the well and provide preliminary hydraulic data following the procedure discussed above in Section 2.8.5. The responses observed in the other existing H-19 wells will be used in preliminary determination of the hydraulic properties and anisotropy of the Culebra at the hydropad.

The preliminary tracer testing program will commence after H-19b4 has been completed, and will involve pumping H-19b1 to establish a convergent flow field and then injecting tracers into H-19b2, H-19b3, and H-19b4. After tracer injection, H-19b1 will continue to be pumped and the pumped fluid will be sampled and analyzed on-site to determine the times of tracer arrival and tracer concentrations. The pumping of H-19b1 will be performed in accordance with WIPP Procedure 505: Pumping Tests. Inasmuch as a convergent-flow tracer test is also a pumping test, the downhole pressures in H-19b1 through H-19b4 will be monitored using pressure transmitters/transducers as discussed above. The pressure responses to the pumping period (and subsequent recovery period if feasible) will be analyzed to provide additional preliminary estimates of the Culebra's transmissivity and storativity, as well as to verify the anisotropy interpreted from the earlier pumping tests in the first four wells. More detailed and

definitive hydraulic and tracer testing will be performed after the completion of the drilling program. Formal Test Plans will be prepared for each of these activities.

The objective of the preliminary tracer testing will be to determine which of the three tested flowpaths provides the fastest tracer transport. The current design calls for borehole H-19b7 to be located on the diametrically opposing side of H-19b1 from the borehole in which the fastest arriving tracer was injected, at the greatest distance feasible for later tracer testing. This distance will be determined from scoping simulations that will take into account the transmissivity and anisotropy of the Culebra at H-19, tracer solubilities, tracer detection limits, and expected tracer dilution during later tests. H-19b5 is planned to be drilled 100 ft from H-19b1, diametrically opposed to whichever borehole has an orientation with respect to H-19b1 that is most closely aligned with the minor axis of the permeability tensor defined by the anisotropy analysis. H-19b6 is planned to be drilled opposite the last of the H-19b2, 3, or 4 boreholes, at a distance from H-19b1 intermediate between that of H-19b5 and H-19b7. These wells locations are subject to modification depending on the interpretation of the preliminary hydraulic and tracer tests.

Tracer concentrations will be analyzed on site using suitable, approved instruments and procedures. The instruments and procedures will be documented in the field notebook for the testing. The primary objective of the analyses will be to establish the fastest groundwater flowpath. Detailed analyses of breakthrough data for colorimetric tracers will not be performed because those tracers are not completely conservative in clay-bearing formations.

The procedures to be used for the preliminary tracer testing are as follows:

1. Install a 4-inch electric submersible pump below an inflatable packer on 2³/₈-inch tubing in H-19b1. The packer will be set in the lower Tamarisk anhydrite below the well casing, and will include feedthroughs for downhole pressure transmitters/transducers. A surface flow-control system equipped with totalizing flow meter and gate and control valves as shown on Figure 3-1 will be used to regulate flow.
2. Install packers and tracer-injection assemblies used for the H-11 convergent-flow tracer test, with downhole pressure transmitters, in H-19b2, H-19b3, and H-19b4. Packers will

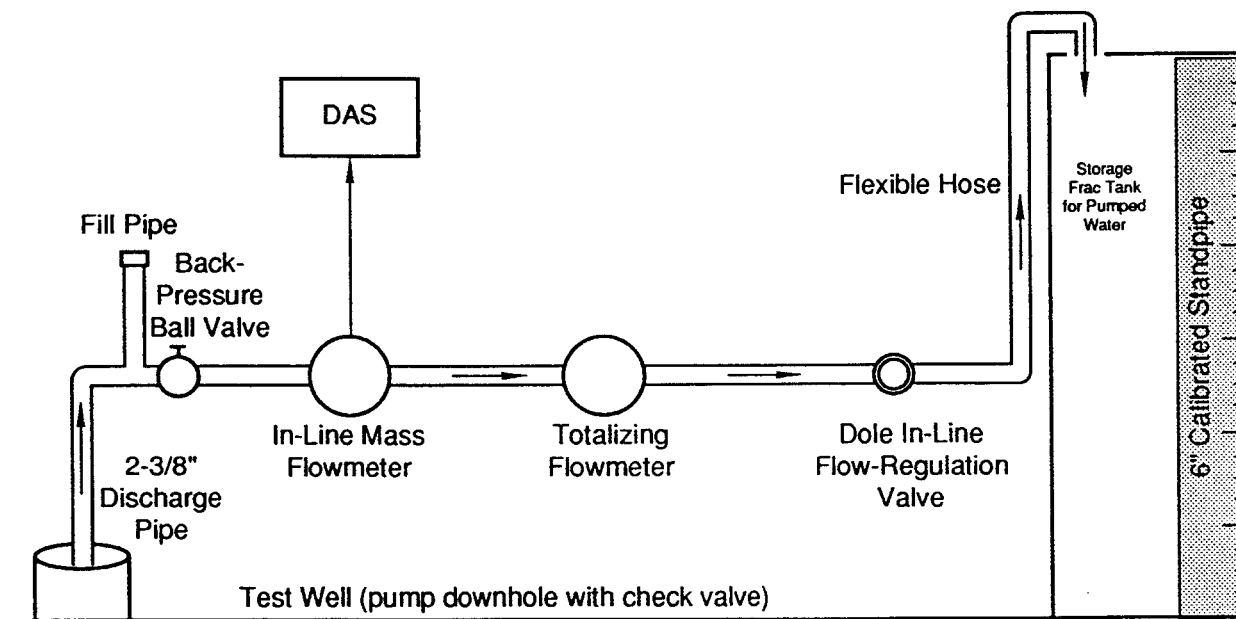

TRI-6115-83-0

Figure 3-1. Schematic illustration of the discharge-measurement system.

be set below the well casing in the lower Tamarisk anhydrite and the tracer-injection assemblies will span the entire Culebra intervals in the wells.

3. Configure DAS to monitor data from all four wells and begin recording operations.
4. Begin pumping H-19b1 to establish convergent-flow field.
5. Mix three tracers in three ~50-gal containers of formation fluid collected during earlier pumping exercises in the H-19 wells. Use benzoic-acid derivatives and/or colorimetric tracers such as uranine, lissamine, and/or an optical brightener as tracers.
6. After convergent-flow field is established, inject tracers in H-19b2, H-19b3, and H-19b4, preferably but not necessarily simultaneously, noting the individual tracers injected in each borehole. Chase each tracer with a volume of untraced formation fluid sufficient to displace all tracer from the wellbore into the formation.
7. Begin sampling and field tracer analysis of flow from H-19b1 every 15 minutes until first tracer arrival is detected. If possible, attempt to anticipate first tracer arrival by utilizing pressure responses noted in H-19b1 during developmental pumping in H-19b2, H-19b3, and H-19b4.
8. Continue pumping and tracer analysis until tracer arrival from all three injection wells has been confirmed.
9. After confirmation of the fast flow path, remove tracer-injection assembly from fast-path well and replace with passive-tracer-injection assembly. Release tracer(s) from downhole vessel and test downhole mixing and detection systems.
10. After peak concentration of passively injected tracer has been detected at pumping well, resume drilling operations at newly established location of H-19b5.
11. Terminate pumping and data collection for tracer test at the discretion of the PI, but continue monitoring pressures in all wells to document responses to drilling.

4. DATA ACQUISITION

Both manually and electronically collected data will be acquired during the drilling and preliminary testing of the boreholes at H-19. The following types of data will be recorded:

- electronically collected downhole pressure data from isolated and/or tested intervals;
- electronically collected downhole tracer-concentration data;
- electronically and/or manually collected pumping rate and volume data from wells being pumped;
- electronically collected barometric-pressure-versus-time data;
- manually collected data on core recovery;
- manually collected water-level data;
- manually collected water-quality data concerning the temperature, pH, specific gravity, and electrolytic conductivity of fluid produced during pumping;
- manually collected data on tracer concentrations in fluid produced during pumping;
- manually collected data on tracer masses, mixing fluid volumes, and injection volumes; and
- manually collected data on equipment and instrument configurations in the wells and at the surface.

The electronic data acquisition will be performed using a DAS similar to the one used for the H-11 convergent-flow tracer test (Stensrud et al., 1990) shown schematically in Figure 3-2. Manual data collection will be carried out either using forms designed specifically for each activity or data type or by recording relevant information in the SR's daily drilling log and/or field logbooks, as appropriate (see Section 7.4). The forms to be used are contained in WIPP procedures that have been prepared for different data-collection activities, including:

WIPP Procedure 505:	Pumping Tests
WIPP Procedure 507:	Instrumentation System Verification During Gage Connection to HP-3497A Stand-Alone Data-Acquisition Systems

- WIPP Procedure 508: Installation of Pressure, Flow Meters, and Thermocouples Gauge Checkout
- WIPP Procedure 509: Operation of PERM DAS Program
- WIPP Procedure 510: Manual Start of Remote Diesel Generators
- WIPP Procedure 512: Depth-to-Water Measurement Using Solinst Brand Electric Sounder
- WIPP Procedure 513: Water-Quality Data: Measurements of Specific Gravity, Conductance, pH, and Temperature
- WIPP Procedure 515: Slug and Drillstem Testing

Copies of all relevant procedures will be kept on file in the field trailer.

5. DATA-QUALITY OBJECTIVES

Table 5-1 lists the data-quality objectives for the instrumentation which may be used in the hydraulic testing and tracer testing described in this FOP. The quality of each data set will also be represented, where appropriate, in terms of precision, accuracy, representativeness, completeness, and comparability.

Table 5-1. Data-quality objectives for instrumentation used in hydraulic and tracer tests

	Flow Meter	Barometer	Heise Gage*	Pressure Transmitter	Conductivity/ Resistivity Meter	pH Meter	Hydrometer	Thermocouple
Operating Range	1-20 gpm	600-1100 mb	0-500 psi	0-200 psi	1×10^4 - 1×10^5 μ S	0-12	1.00-1.07 1.06-1.13	0° - 50°C
Resolution	0.1 gal	4.83 ms/mb	0.05 psi	± 0.2 psi	± 1% full scale	0.01	0.0005	0.2°C
Accuracy	±0.2% - 0.5%	0.48 - 0.88 mb	± 0.5 psi	± 2 psi	± 2% full scale	± 0.1% of setting	0.001 g/mL	±0.5°C
Temperature Range	0° - 40°C	-10° - 40°C	N/A	-10° - 40°C	N/A	N/A	N/A	N/A
Precision	± 0.1%	N/A	± 0.1 psi	± 0.5 psi	N/A	N/A	N/A	N/A
Hysteresis	N/A	N/A	< 0.05 psi	± 0.5 psi	N/A	N/A	N/A	N/A
Non-linearity	N/A	N/A	N/A	± 0.5 psi	N/A	N/A	N/A	N/A
Temperature Effects	N/A	N/A	N/A	± 0.6 psi	N/A	N/A	N/A	N/A
Vibration	compensated	N/A	N/A	N/A	N/A	N/A	N/A	N/A

* May be used in equipment calibration

6. REGULATORY REQUIREMENTS

Westinghouse WID is responsible for ensuring that WIPP-site activities are conducted in accordance with applicable federal, state, and local regulatory requirements. The WID is responsible for assessing regulatory impact and compliance and obtaining necessary permits. Appropriate NEPA checklists governing the proposed drilling and preliminary testing have been generated and approved. SNL is responsible for ensuring that all contracted experimental work performed by SNL contractors at the WIPP site meets all applicable federal, state, and local regulatory requirements. All work performed for this FOP will be in compliance with all SNL ES&H policies and guidelines.

6.1 Tracer Qualification

The preliminary tracer testing performed as part of this FOP will involve the use of colorimetric and/or benzoic-acid tracers. These or similar substances have been used previously for WIPP-site tracer testing. Individual colorimetric tracers that might be used for the testing include uranine, lissamine, and/or optical brighteners. Each compound used as a tracer will have appropriate MSDS information available on site during the conduct of the testing. No tracers will be used that have not been approved for safe use and disposal by the U.S. EPA and/or the State of New Mexico.

6.2 Waste-Water Disposal

All water used in drilling and formation water produced during testing will be stored on site in steam-cleaned containers before being transported to a licensed disposal facility. Three samples of the water in each container will be collected and analyzed by WID and the suitability of the disposal facility to receive those waters will be verified by WID Environmental Compliance and Support before any waste water is transported off the WIPP site. All off-site disposal will be accomplished by contracting licensed hauling services. Manifests documenting the disposal of all waste water at the licensed facility will be provided by the hauler to the SNL ES&H representative, who will transmit them to WID Environmental Compliance and Support.

7. QUALITY ASSURANCE

7.1 Quality Assurance Program Description

The activities described in this FOP will be conducted in accordance with all appropriate SNL QA/QC requirements as specified in the WIPP QAPD (SNL, most recent version). The WIPP QAPD meets the requirements of NQA-1-1989 (ASME, 1989), DOE 5700.6c, and Chapter 11 of the *Final Safety Analysis Report* (WP 02-9). The WIPP QAPD has been approved by the DOE Carlsbad Area Office (CAO) for all WIPP activities assigned to SNL and is specific to the WIPP project. Contractor personnel working with SNL personnel at the WIPP site are also subject to the WIPP QAPD.

Specific items that are subject to the WIPP QAPD and procedures are:

- scoping calculations and associated software development;
- engineering drawings showing test equipment and interconnection of different testing apparatus;
- test analyses and interpretation;
- instrument calibration data; and
- all testing documentation including photographs, field notebooks, written procedures, data or calculation worksheets, installation diagrams, and installation or test-operation forms.

The SNL PI, SNL contractors, or other personnel designated by the SNL PI to participate in the operations described in this FOP will be responsible for data acquisition, storage, and safety and for ensuring that all appropriate documentation is completed in accordance with the WIPP QAPD. All field changes, deviations, and other nonconformances with the approved FOP will be documented in accordance with the WIPP QAPD.

7.2 Data Integrity

Care will be taken throughout the performance of the operations for this FOP to ensure the integrity of all data collected including paper documentation and data collected on magnetic media. Duplicate copies of all data will be produced no less frequently than weekly and duplicate copies will be maintained in separate facilities to ensure that data are not lost. Data transfer will be performed using procedures described in the WIPP QAPD to ensure the traceability of all transferred data.

7.3 Instrument Calibration

All work performed by or for SNL as part of this FOP will be performed with calibrated instruments and equipment in accordance with the WIPP QAPD. Calibration data will be maintained on site throughout the conduct of the drilling program and duplicate copies will be maintained in a separate location. Instruments requiring periodic calibration will be removed from service according to QA maintenance schedules and calibrated before being returned to service. All equipment calibrated by the manufacturer will not be allowed to be utilized in the drilling and testing under this FOP until current calibration data are supplied for the equipment. Manufacturer's calibration data will become part of the permanent testing documentation.

7.4 Required Reports

The following reports will be required to ensure proper documentation of activities under the WIPP QAPD.

7.4.1 Daily Drilling Log and Borehole History

The SR shall maintain a daily drilling log that shows dates and time of operations, site personnel including rig crews, drilled and cored intervals, drilling time of cored intervals, drilling weight, rotary speed and circulation rate, type of circulating fluid, tested intervals, and any other information germane to the field operations. The SR shall also document all inspections,

decisions, and changes in plans in this daily drilling log. Following completion of field activities associated with the drilling and coring operations, a borehole history of the drilling activities will be prepared by the SR from these and other pertinent records. A reproducible copy of this borehole history will be forwarded to Manager, SNL WIPP Site Operations Department 6743, and to the SNL PI, Geohydrology Department 6115.

7.4.2 Daily Report

The SR will prepare a daily report of activities, summarized from the daily drilling log, for the Manager, SNL WIPP Site Operations Department 6743. Daily reports will also be telefaxed to the SNL PI, Geohydrology Department 6115. Copies of the daily reports will be kept on file in the SNL field trailer at the H-19 hydropad.

7.4.3 Field Logbooks

Separate field logbooks shall be kept for (1) core logging and (2) hydraulic and tracer testing activities. These shall be bound logbooks with sequentially numbered duplicate pages for carbon copies. The field logbook for core logging is the responsibility of the site geologist and shall contain, at a minimum:

- times, dates, and intervals of all core runs;
- core recoveries (percentage) from each core run, explaining probable location(s) of core loss;
- pipe tallies and other information used to establish core depth;
- an inventory of core boxes, listing core run(s) and intervals in each box;
- a log of all core photographs taken;
- information on cleaning, wetting, and breaking of core; and
- any other information pertinent to the condition of the core.

The field logbook for hydraulic and tracer testing is the responsibility of the HTC and shall contain, at a minimum:

- times, dates, and intervals of all hydraulic and tracer tests;
- lists of all WIPP procedures used for each test;
- lists, including model and serial numbers, of all equipment used in the tests;
- tubing tallies and other information used to establish test depths;
- sketches of all equipment configurations, showing measured dimensions;
- a log of all photographs taken of the equipment and activities;
- step-by-step descriptions of all activities performed;
- rationale for, and documentation of, all decisions concerning test intervals, durations, deviations from procedures, or other factors;
- a record of all manually performed measurements;
- a log of all samples collected;
- a log of data files collected by the DAS; and
- any other information pertinent to the testing.

The field logbooks can be supplemented by data contained on forms, but each individual form and its contents must be noted in the appropriate field logbook.

7.4.4 Miscellaneous Records

Several types of records will be kept on site during the conduct of field operations. Copies of these records will be kept at the office of the Manager, SNL WIPP Site Operations Department 6743, and other copies will be forwarded to Geohydrology Department 6115 and the SWCF. These records will be useful in documenting the history of the field operations and include:

- driller's daily summary sheets, drilling-bit inventories, and drilling-fluid history;
- drilling-rig and other equipment certifications;
- drilling-history charts;
- waste-water disposal manifests;
- equipment manifests; and
- cost and billing information regarding contracted services.

8. SAFETY

SNL field operations will be conducted on land controlled by the WID and the field operations team assembled for this FOP will follow all WID safety practices and policies. Two SNL SOPs and hazard analyses instituted for geotechnical fieldwork have been submitted for WID approval:

- ES&H SOP, SP472433, Geotechnical Field Operations for Department 6111 (Department 6111 9/92); and
- ES&H SOP, SP471049, Use of (Logging and Support) Vehicles at Field Sites (Department 6111 6/91).

Operational safety for individual field operations will be addressed through the SNL ES&H SOPs developed by SNL. Project-specific WIPP-site safety procedures will be approved through the SNL PI, WIPP-site WID safety personnel, and the SNL WIPP-site Safety Advisor. ES&H SOPs applicable to the drilling program include those relating to identification of potential hazards; emergency-shutdown procedures; and personnel to be contacted in case of emergencies.

8.1 Safety Requirements

The equipment required for this FOP will include commercially available or SNL-fabricated equipment that will be tested and approved for use. All equipment will be operated in accordance with the appropriate allowable operating pressures and in accordance with the SNL ES&H pressure-safety manual. Pressure ratings for individual parts such as valves and pressure tubing will be either marked by the manufacturer with the maximum allowable operating pressure or such information will be made available in written documentation according to guidelines of the SNL Center 6700 Safety Representative for WIPP-Site Operations, or the SNL Center 6100 or 6300 Pressure Safety Advisor for WIPP-site test operations.

Additional safety requirements to be observed by field personnel are:

1. appropriate use of safety shoes, safety glasses, hard hats, and protective gloves;
2. ensuring adequate fuel is available for all field vehicles, especially those traveling to remote locations;
3. proper installation and safety procedures when handling electrical submersible pumps and other electrical equipment;
4. proper procedures for operation of diesel-powered generators for on-site electric power;
5. observation of scheduled working hours and driving time;
6. familiarity with on- and off-site road conditions and driving regulations;
7. familiarity with the locations of First Aid supplies, medical support facilities, and fire extinguishers and other safety equipment;
8. familiarity with the location of lists of emergency telephone numbers and persons and offices to notify in the event of emergencies;
9. familiarity with the location of posted crew schedules; and
10. familiarity with the location of all MSDS information.

All field personnel assigned to the field operations described in this FOP will receive a safety briefing before the beginning of field operations. In addition, the field-site or shift supervisor will conduct daily safety meetings at the beginning of daily operations or at the beginning of each shift. All personnel receiving safety briefings are required to sign and date the safety-briefing form as part of safety-documentation procedures.

The use of colorimetric tracers does not require additional safety considerations. The compounds to be used as tracers are considered to be generally safe and nontoxic.

8.2 Special Training

All SNL and WIPP-site contractor personnel must receive WIPP-site General Employee Training (GET) followed by annual refreshers as part of employment requirements at WIPP. No other special training requirements are anticipated in addition to the GET and the safety briefings described in Section 8.1.

9. REFERENCES

- American Society of Mechanical Engineers. 1989. *Quality Assurance Program Requirements for Nuclear Facilities*. ASME NQA-1-1989 Edition. New York, NY: ASME.
- Sandia National Laboratories. 1992. *Waste Isolation Pilot Plant Quality Assurance Program Description, Revision P*. Albuquerque, NM: Sandia National Laboratories.
- Stensrud, W.A., M.A. Bame, K.D. Lantz, J.B. Palmer, and G.J. Saulnier, Jr. 1990. *WIPP Hydrology Program, Waste Isolation Pilot Plant, Southeastern New Mexico, Hydrologic Data Report #8*. SAND89-7056. Albuquerque, NM: Sandia National Laboratories.
- WIPP Performance Assessment Department. 1993. *Preliminary Performance Assessment for the Waste Isolation Pilot Plant, December 1992, Volume 4: Uncertainty and Sensitivity Analyses for 40 CFR 191, Subpart B*. SAND92-0700/4. Albuquerque, NM: Sandia National Laboratories.

DISTRIBUTION

INTERNAL:

R.W. Lynch, 6100, MS0701
A.R. Sattler, 6111, MS1033
P.B. Davies, 6115, MS1324
R.L. Beauheim, 6115, MS1324 (10)
C.S. Chocas, 6115, MS1324
A.R. Lappin, 6115, MS1324
L.C. Meigs, 6115, MS1324
E.J. Nowak, 6119, MS1320
H.W. Papenguth, 6119, MS1320
W.D. Weart, 6303, MS1335
S.A. Goldstein, 6305, MS1335
A.L. Stevens, 6306, MS1341
L.R. Hill, 6347, MS1345
C.J. Mewhinney, 6700, MS1395
N.C. Simmons, 6700, MS1395
J.R. Trone, 6700, MS1395
L.E. Shephard, 6701, MS1395
V. Harper-Slaboszewicz, 6743, MS1395
D.L. Cole, 6743, MS1395
K. Riley, 6743, MS1395
J.W. Mercer, 9333, MS1156
Technical Library, 7141, MS0899
Technical Publications, 7151, MS0619
Document Processing for DOE/OSTI, 7613-2, MS0100 (5)
Central Technical Files, 8523-2, MS9018
SWCF-A, MS1330: 1.1.5.3.4; Field Studies; Test Plans (5)

EXTERNAL:

M.H. McFadden, DOE/CAO
G.T. Basabilvazo, DOE/CAO (5)
R.J. Lark, DOE/CAO (2)
E.K. Hunter, DOE/CAO (2)
C.M. Cox, WID, WIPP (3)
M.E. Whatley, WID, WIPP (2)
L.G. Eriksson, WTAC (6)
W.A. Stensrud, INTERA, WIPP (6)
G.J. Saulnier, INTERA, Austin (10)
M.B. Kloska, INTERA, Albuquerque (3)

Sandia National Laboratories

Albuquerque, New Mexico 87185-1324

date: March 24, 1995

to: Jerry Mercer, 9333, MS1156



from: Rick Beauheim, 6115, MS1324

subject: Deviation from Field Operations Plan: Well Construction and Preliminary Testing on the H-19 Hydropad at the WIPP Site

Due to the drilling tools lost in well H-19b1, that well location will be abandoned. To preserve the desired well symmetry on the hydropad, a new location for the central well will be established. The location for the new well, to be designated H-19b0, is to be 50 ft due south of the H-19b1 location. With reference to Figure 2-1 in the Field Operations Plan (FOP), we will preserve the old locations established for wells H-19b3 and H-19b4, and relocate H-19b2 50 ft due south of H-19b0. The orientations of wells H-19b5, H-19b6, and H-19b7 will also be shifted from those shown on Figure 2-1. A figure showing the revised well layout is attached. As before, the exact locations of H-19b5, H-19b6, and H-19b7 are tentative -- final positions will be determined following the preliminary tracer test.

With regard to H-19b0, no coring will be performed above the casing point as the required core has already been obtained from H-19b1. The hole should be rotary drilled to the casing point in the lower Tamarisk as quickly as possible. At that point, we will resume operations at step 9 outlined for the primary borehole in the FOP, Section 2.1, p. 8.

Please contact me if you have any questions about this deviation from the FOP.

cc: P.B. Davies, 6115
A.R. Lappin, 6115
L.C. Meigs, 6115
C.S. Chocas, 6115
A.R. Sattler, 6111, MS1033
J.R. Trone, 6700, MS1395
D.L. Cole, 6743, MS1395
SWCF-A, MS 1330: 1.1.5.3.4; Field Studies, Test Plans
M.B. Kloska, INTERA
W.A. Stensrud, INTERA/WIPP

H-19 Hydropad (450 ft x 450 ft)

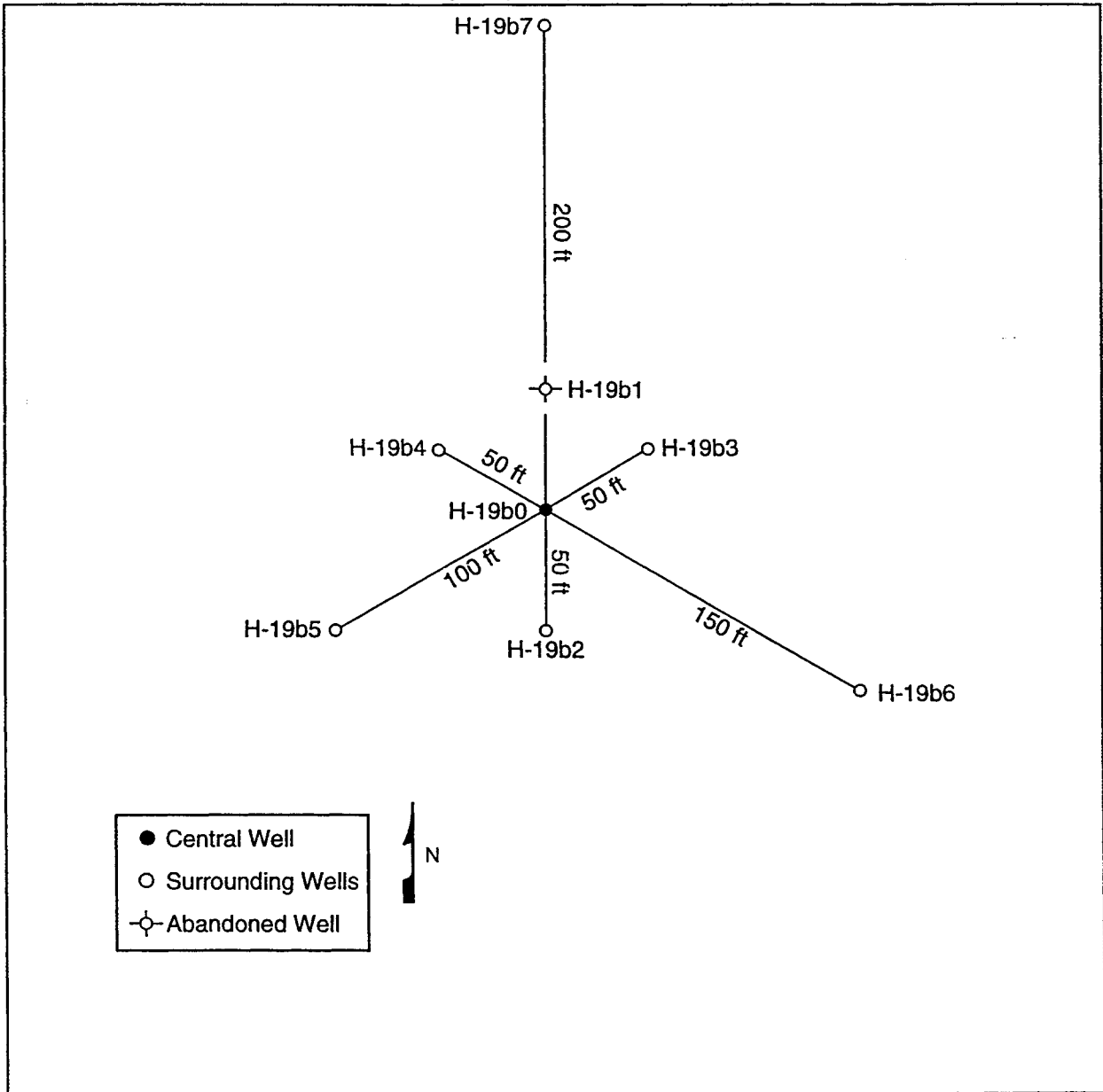

TRI-6115-36-4

date: July 19, 1995

to: Distribution



from: Rick Beauheim, 6115, MS 1324

subject: Memorandum of Record documenting modifications to Field Operations Plan: Well Construction and Preliminary Testing on the H-19 Hydropad at the WIPP Site

The purpose of this memorandum is to document modifications made to the referenced Field Operations Plan (FOP). These modifications are not significant changes that alter the objectives of the FOP, but refinements that: 1) clarify coring procedures; 2) permit the use of the BASys data-acquisition system; 3) clarify the requirements for manual data acquisition; 4) change the data-quality objectives to reflect test requirements and not instrument specifications; 5) clarify the quality assurance requirements; 6) allow changes to procedures during field operations; 7) clarify instrument calibration requirements; and 8) clarify records requirements and allow more flexibility in documenting the work.

1. Change the second paragraph of Section 2.4.1 as follows:

The site geologist shall ensure QA records (see section 7.4.3) are kept showing dates and times of all core runs, beginning and ending depths of all core runs (established as outlined in Section 2.9), core recovery percentage from each run, and such variations in penetration rate as might be observed. The QA records shall also include a core-photography log listing all photographs taken and associated depths (see Section 2.4.5) as well as a summary of how the core is boxed. Copies of all QA records will be kept on site throughout the drilling and coring operation.

2. Change the last sentence in Section 2.4.2. as follows:

Troughs will be marked with different distinct colors at each end, preferably red at the top end and black at the bottom indicating down direction of the core.

3. Change Section 2.4.3 as follows:

The site geologist will log the core at the time of collection using SNL WIPP Form Number 393: General Purpose Core-Log Inventory. The core pieces shall be matched together

as snugly as possible and two parallel lines shall be drawn down the length of the core using indelible markers. The downward direction of the core shall be clearly indicated. Each complete core run will be marked in feet and tenths of feet. The reference datum for depth will be the primary datum established by the SR. Any lost core will be logged at the bottom of each interval unless known to be otherwise and so explained on the core log. Core loss should be indicated in the core-storage boxes using a block of wood with the estimated core-loss interval marked with visible waterproof ink.

A detailed geologic description of the core shall be recorded on the core logging form. Lithologic, sedimentologic, and mineralogic variations shall be noted, with depths referenced to at least the nearest 0.1 ft. All visible fractures shall be logged at the depth of the midpoint of the fracture, and the dip angle and fracture filling or staining (if any) shall be noted. At this time, no closed features, such as cemented fractures, shall be opened by the site geologist or other field person. Such features shall be preserved for later deliberate study of delicate mineral or structural features, including measurement of fracture apertures.

4. Change the last sentence in Section 2.4.4. as follows:

If core is washed with other fluids, this occurrence will be documented, stating the type of fluid, the intervals so exposed, and the date and time of the occurrence.

5. Change Section 2.4.6 as follows:

After the core has been photographed, it will be boxed for storage in the WIPP-site core library. The following core will be sleeved prior to being placed in core boxes: a) claystone and mudstone from the Rustler Formation interbeds, b) all core from the Magenta Dolomite Member, and c) all core from the Culebra Dolomite Member. It is permissible, but not required, to sleeve other core. All core boxes shall be labeled sequentially with well number, date, core run number, and depths of the core pieces in each box. Breaking the core to fit the boxes should be minimized as much as possible. All artificial breaks shall be documented and shall also be indicated on the core itself using an indelible marker. After completion of coring in each hole, a Sample Chain of Custody (Form 126) will be prepared in accordance with WIPP Procedure 263: Sample Tracking System. The core boxes and chain of custody will be transmitted to the WID core library, where the core will be logged in by the WID core-library custodian. All core must be protected from freezing between the time it is collected and when it is transferred to the core library.

6. Change the last sentence in Section 2.8.1 as follows:

The HTC will document the test intervals selected for all hydraulic and tracer tests.

7. Change the third sentence in section 2.8.2 as follows:

The pressure (and temperature) data will be monitored and recorded using a computer-controlled DAS (see Section 4).

8. Change the second paragraph, third sentence in Section 3 as follows:

A computer-controlled DAS will be used to monitor and record the pressure data.

9. Change the second paragraph of Section 4. to:

The electronic data acquisition will be performed using computer-controlled DASs. Data will be acquired using either the SNL PERM DAS similar to the one used for the H-11 convergent-flow tracer test (Stensrud et al., 1990) shown schematically in Figure 2-4 or the Baker Oil Tools BASys system. The DASs will send and receive signals to/from the pressure- and temperature-measurement devices and record their responses on the computer's hard disk and floppy diskettes. Data acquired from the flow-control system and downhole pressure sensors will be operationally verified using WIPP Procedure 507: Installation System Verification During Gage Connection to HP-3497A Stand-Alone Data-Acquisition Systems. The SNL PERM DAS code is being qualified in accordance with SNL WIPP QAP 19-1, Rev. F, for Grade A codes and as specified in WIPP Procedure 509: Operation of the PERM DAS Program. The BASys DAS is leased from the supplier and is controlled by proprietary software. This system will undergo verification testing prior to use and will be operated as specified by the user's manual provided by the supplier.

10. Delete the list of WIPP Procedures from Section 4 and add the following text:

Manual data collection will be carried out either using forms designed specifically for each activity or data type or by other appropriate means. To minimize transcription errors and multiple recordings of the same information, the use of forms specified in the WIPP procedures is not mandatory. The HTC will ensure that all quality-affecting information is documented as part of the QA records.

11. Change the following data-quality objectives in Table 5-1 as indicated below:

Barometer:	Resolution: 5 mb	Accuracy: ±10mb
Pressure Transmitter:	Temperature Range: 0° - 40°C	
Hydrometer:	Resolution: 0.001 g/mL	Accuracy: ±0.002 g/mL

12. Replace Section 7.0 with the following text:

7. QUALITY ASSURANCE

7.1 Quality Assurance Requirements

7.1.1 Hierarchy of Documents

Several types of documents are used to control work performed under this FOP. If inconsistencies or conflicts exist among the requirements specified in these documents, the following hierarchy shall apply:

- Memorandum or other written instruction modifying the FOP (most recent instructions having precedence over previous instructions)
- Field Operations Plan: Well Construction and Preliminary Testing on the H-19 Hydropad at the WIPP Site
- SNL WIPP QAPD, Rev. P (see Section 7.1.3)
- SNL WIPP Quality Assurance Procedures (see Section 7.1.4)
- SNL WIPP Procedures (see Section 7.1.5)

7.1.2 Quality-Affecting Activities

The majority of activities performed under this FOP, including drilling and well development, diesel generator operation, water-quality data, and preliminary testing activities, are not quality affecting as they do not provide information which supports Performance Assessment or regulatory compliance. These activities are not subject to the requirements of the SNL Quality Assurance Program Description or Quality Assurance Procedures, but will be conducted according to industry standards and as described in this FOP.

Information that is quality affecting includes:

- borehole and core depths
- geophysical logs
- core logs
- borehole-deviation surveys
- caliper logs
- fracture location and orientation information
- the single-well tracer test (see letter from L. Shepherd to D. Lark date June 7, 1995)

7.1.3 Quality Assurance Program Description

Quality-affecting activities conducted under this FOP are subject to the following quality assurance requirements as specified in the SNL WIPP Quality Assurance Program Description (QAPD), Rev. P:

- Section 2, Quality Assurance Program (Sections 2.3, 2.5, 2.6, and 2.7);

- Section 4, Procurement Document Control;
- Section 6, Document Control;
- Section 7, Control of Purchased Items and Services;
- Section 8, Identification and Control of Items;
- Section 11, Test Control (Sections 11.1 and 11.2 only)
- Section 12, Control of Measuring and Test Equipment;
- Section 13, Handling, Storage, and Shipping;
- Section 15, Control of Nonconformances;
- Section 16, Corrective Action;
- Section 17, Quality Assurance Records; and
- Section 19, Computer Software

The SNL WIPP QAPD meets the requirements of NQA-1-1989 (ASME, 1989), DOE 5700.6c, and Chapter 11 of the *Final Safety Analysis Report* (WP 02-9). The WIPP QAPD has been approved by the DOE Carlsbad Area Office (CAO) for all WIPP activities assigned to SNL.

Due to schedule and budget constraints, revisions to the SNL QAPD effective after approval of this FOP will not apply unless directed by the SNL PI or HTC.

7.1.4 Quality Assurance Procedures

Various aspects of the quality affecting-work described in this FOP are controlled by one or more SNL WIPP Quality Assurance Procedures (QAPs). The QAPs relevant to operations conducted under this FOP include:

- QAP 2-2, Rev D, Qualification & Training Program
- QAP 4-1, Rev A, WIPP Contractor Quality Assurance Requirements
- QAP 6-1, Rev. D, Document Control Procedure
- QAP 12-1, Rev. A, Calibration Program
- QAP 17-1, Rev. K, QA Records Requirements
- QAP 19-1, Rev. F, WIPP Computer Software Requirements

Due to schedule and budget constraints, revisions to the SNL QAPs effective after approval of this FOP will not apply unless directed by the SNL PI or HTC.

7.1.5 WIPP Procedures

The WIPP Procedures which may apply to work performed under this FOP include:

- WIPP Procedure 263: Sample Tracking System
- WIPP Procedure 472: Intensifier Pump: Operation and Use
- WIPP Procedure 505: Pumping Tests
- WIPP Procedure 507: Installation System Verification During Gage Connection to HP-3497A Stand-Alone Data-Acquisition Systems
- WIPP Procedure 509: Operation of PERM DAS Program
- WIPP Procedure 510: Manual Start of Remote Diesel Generators

- WIPP Procedure 512: Depth-to-Water Measurement Using Solinst Brand Electric Sounder
- WIPP Procedure 513: Water Quality Data: Measurements of Specific Gravity, Conductance, pH, and Temperature
- WIPP Procedure 514: Verification of Totalizing Flow Meter Measurements Using a Verified Standpipe
- WIPP Procedure 515: Slug and Drillstem Testing

Operation of diesel generators as described in WIPP Procedure 513 is not a quality-affecting activity and, therefore, the maintenance of records (e.g., Form 146) is not mandatory and will be done at the discretion of the HTC.

Modifications to these procedures may be required during the field operations. Such modifications are not deviations and will not be reported as nonconformances that require corrective action. However, modifications will be documented as part of the QA records.

7.2 Data Integrity

Care will be taken throughout the performance of the operations for this FOP to ensure the integrity of all data collected including documentation on hard copy and data collected on magnetic media. Duplicate copies of all data will be produced no less frequently than monthly and the duplicate copies will be maintained at a location separate from the H-19 hydropad to ensure that data are not lost. Data collected during testing activities shall not be released unless and until the data are reviewed and approved by the SNL PI.

7.3 Instrument Calibration

All quality-affecting work performed by or for SNL as part of this FOP will be done with calibrated instruments and equipment in accordance with the WIPP QAPD and QAP 12-1.

Measurements of specific gravity, conductance, pH, and temperature as specified in WIPP Procedure 513 are qualitative in nature and are used only to indicate relative changes in the quality of the fluid produced from the H-19 wells. Instruments used for these measurements should meet the data-quality objectives (see Table 5-1), as determined by the manufacturers' specifications, but will not require calibrations traceable to NIST or other nationally recognized standards.

Hydrometers and thermometers used to perform specific gravity measurements as part of drillstem and slug tests must be certified by the manufacturer to meet the data-quality objectives specified in Table 5-1.

NIST or other nationally recognized standard are not available for geophysical logging. Calibration of geophysical logging instruments shall be conducted according to the contractor's procedures.

7.4 Required Records

Records shall be maintained as described in this FOP and referenced QA implementing procedures. These records may consist of bound notebooks, loose-leaf pages, forms, printouts, or information stored on electronic media. The minimum requirements for records are discussed below.

7.4.1 Daily Drilling Log and Borehole History

The SR shall maintain a daily drilling log that shows dates and time of operations, site personnel including rig crews, tallies and measurements used to establish borehole depths, drilled and cored intervals, drilling time of cored intervals, type of circulating fluid, tested intervals, and any other information germane to the field operations.

7.4.2 Daily Report

The SR will prepare a daily report of activities, summarized from the daily drilling log, for the Manager, SNL WIPP Site Operations Department 6743. Daily reports will also be telefaxed to the SNL PI, Geohydrology Department 6115. Copies of the daily report will be kept on file in the SNL field trailer at the H-19 hydropad.

7.4.3 Core Logging

Unless otherwise directed by the SNL PI, the site geologist shall be responsible for maintaining records of core logging activities, including:

- times, dates, and intervals of all core runs;
- persons performing core logging;
- core recoveries (percentages) from each core run, explaining probable locations(s) of core loss;
- information establishing core depths;
- geologic description of the core;
- logs of all photographs taken;
- information on cleaning, wetting, and breaking of core;
- other information pertinent to the condition of the core; and
- an inventory of core boxes

7.4.4 Hydraulic and Tracer Testing

Unless otherwise directed by the SNL PI, the HTC is responsible for maintaining records related to hydraulic and tracer tests. Where applicable, documentation will include:

- times, dates, and intervals of all hydraulic tests;
- persons performing tests;
- test procedures used;

- equipment and tools used, including model, make, and serial number where applicable;
- tubing tallies or other information used to establish test depths;
- sketches of equipment configurations, along with dimensions;
- log of photographs taken of the equipment and activities;
- description of activities performed;
- rationale for decisions concerning test intervals, durations, modifications to procedures, or other factors;
- manually collected data,;
- data files collected by the DAS;
- samples collected; and
- other information pertinent to the testing.

7.4.5 Miscellaneous Records

Additional records that are useful in documenting the history of the field operations may be maintained and submitted to the SWCF. These records include:

- driller's daily summary sheets, drilling-bit inventories, and drilling-fluid history;
- drilling-rig and other equipment certifications;
- drilling-history charts;
- water-quality measurements;
- information related to operation of diesel generators;
- waste-water disposal manifests;
- equipment manifests; and
- cost and billing information regarding contracted services.

These records do not support Performance Assessment or regulatory compliance and, therefore, are not quality-affecting information.

7.4.6 Submittal of Records

Records resulting from work conducted under this FOP, including forms and data stored on electronic media, will not be submitted to the SNL Quality Assurance Department for review and approval as specified in the WIPP procedures. Instead, the records will be assembled into records package(s) which will be reviewed by the SNL PI and submitted to the SWCF.

Distribution:

MS 1324 P. Davies, 6115
MS 1324 A. Lappin, 6115
MS 1324 R. Beauheim, 6115
MS 1324 L. Meigs, 6115
MS 1324 C. Chocas, 6115
MS 1341 A. Stevens, 6706
MS 1495 N. Simmons, 6700
MS 1495 N. Tencza, 6700
MS 1495 Dave Cole, 6743
MS 1156 J. Mercer, 9333
MS 1033 A. Sattler, 6111
MS 1495 Lillie Austin , 6743 (attn: J. Mercer, A. Sattler)
MS 1495 Don Fulton, INTERA, WIPP
MS 1495 Wayne Stensrud, INTERA, WIPP
MS 1495 Carl Young, INTERA, WIPP
Matthias Kloska, INTERA (Albuquerque)
George Saulnier, INTERA (Austin)
SWCF-A:1.1.5.3.4:PUB:Test Plan:QA:H-19 FOP

Page intentionally left blank.

Sandia National Laboratories

Albuquerque, New Mexico 87185-1324

date: June 9, 1995

to: Dave Cole, 6743, MS1395



from: Rick Beauheim, 6115, MS1324

subject: Location and Drilling of Well H-19b5

We have established the location for the next well to be drilled at the H-19 hydropad, H-19b5, and would like drilling to begin as soon as possible. Relative to the surface location of well H-19b0, H-19b5 should be drilled 19 ft south and 40 ft west. This location is shown on the attached figure. Please measure and stake this location so Abbott Bros. can set surface casing for this well tomorrow. This is not a high-precision task; a few feet one way or another does not matter.

H-19b5 is to be rotary drilled to the casing point in the lower Tamarisk. No core will be taken to the casing point. After the hole is cased, we will have to wait until the preliminary tracer test is completed before coring through the Culebra. If we know where we want to drill the sixth well before the tracer test is completed, we may want to move the rig to that location and complete that hole before pulling back over H-19b5 to core the Culebra. The Culebra will be cored in H-19b5 (and all other new wells) using compressed air as the circulation medium. The Culebra interval will then have to be reamed using the 5 $\frac{1}{8}$ -inch bit so that the hole is the same size as H-19b2, 3, and 4.

Please confer with Jerry Mercer, Allan Sattler, and the drilling crew about how the drilling practice might be improved to reduce hole deviation. If drilling needs to be slowed down, thereby increasing the time required to complete a well, so be it.

Please contact me if you have any questions about these directions.

cc: A.R. Sattler, 6111, MS0706
P.B. Davies, 6115, MS1324
A.R. Lappin, 6115, MS1324
L.C. Meigs, 6115, MS1324
C.S. Chocas, 6115, MS1324
J.W. Mercer, 9333, MS1156
M.B. Kloska, INTERA
W.A. Stensrud, INTERA, WIPP
SWCF-A:1.1.5.3.4:FOP:QA:H-19 well locations

H-19 Well Surface Locations

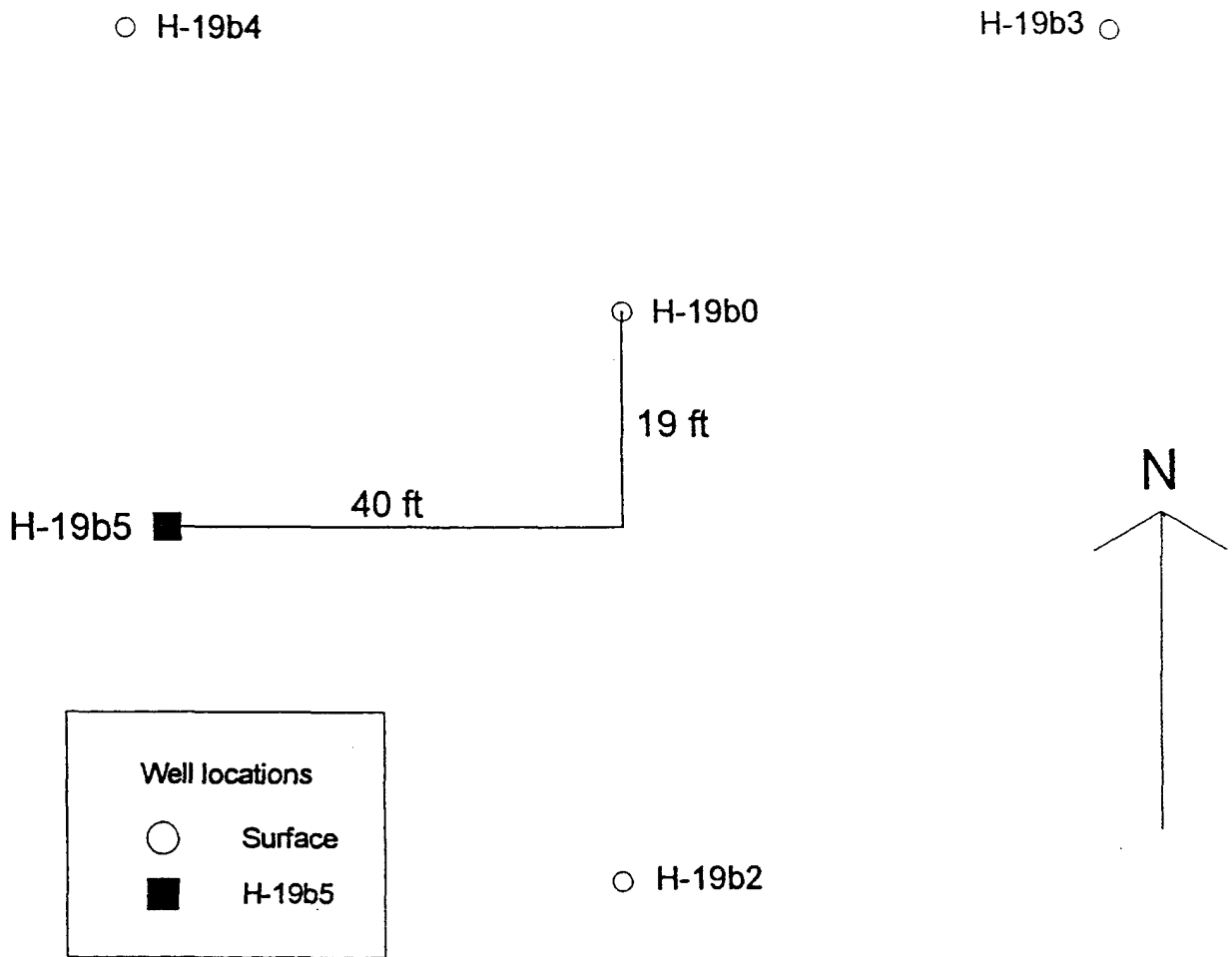

Sandia National Laboratories

Albuquerque, New Mexico 87185-1324

date: July 7, 1995
to: Dave Cole, 6743, MS1395

from: Rick Beauheim, 6115, MS1324
subject: Location and Drilling of Well H-19b6

We have established the location for the next well to be drilled at the H-19 hydropad, H-19b6, and would like drilling to begin as soon as possible. Relative to the surface location of well H-19b1, H-19b6 should be drilled 19.3 ft north and 10.9 ft east. This location is shown on the attached figure. Please measure and stake this location so Abbott Bros. can set surface casing as soon as they can be mobilized. This is not a high-precision task; a foot one way or another does not matter.

H-19b6 is to be rotary drilled to the casing point in the lower Tamarisk. No core will be taken to the casing point. After the hole is cased, you can either wait on the hole until the cement has set for the required time and then immediately complete the hole through the Culebra, or you can move the rig over to H-19b5 and complete that hole through the Culebra and then move the rig back to complete H-19b6. In either case, drilling takes priority over other activities on the pad. The preliminary tracer test will end when you are ready to core through the Culebra in either H-19b5 or H-19b6. The Culebra will be cored in H-19b6 (and all other new wells) using compressed air as the circulation medium. The Culebra interval will then have to be reamed using the 5 $\frac{1}{8}$ -inch bit so that the hole is the same size as H-19b2, 3, and 4.

Please contact me if you have any questions about these directions.

cc: A.R. Sattler, 6111, MS0706
P.B. Davies, 6115, MS1324
A.R. Lappin, 6115, MS1324
L.C. Meigs, 6115, MS1324
C.S. Chocas, 6115, MS1324
J.W. Mercer, 9333, MS1156
M.B. Kloska, INTERA
W.A. Stensrud, INTERA, WIPP
SWCF-A:1.1.5.3.4:FOP:QA:H-19 well locations

Exceptional Service in the National Interest

H-19 Well Surface Locations

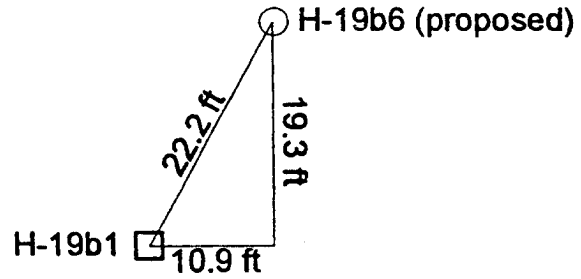

○ H-19b4

H-19b3 ○

○ H-19b0

○ H-19b5

○ H-19b7 (proposed)

7/7/95 12:15 p.m.

○ H-19b2

Sandia National Laboratories

Albuquerque, New Mexico 87185-1324

date: July 24, 1995

to: Dave Cole, 6743, MS1395



from: Rick Beauheim, 6115, MS1324

subject: Location and Drilling of Well H-19b7

We have established the location for the next well to be drilled at the H-19 hydropad, H-19b7, and would like drilling to begin as soon as possible. Relative to the surface location of well H-19b0, H-19b7 should be drilled 28.9 ft south and 4.1 ft east. This location is shown on the attached figure. Please measure and stake this location so Abbott Bros. can set surface casing as soon as they can be mobilized. This is not a high-precision task; a foot one way or another does not matter.

H-19b7 is to be rotary drilled to a depth of 685 ft in the Tamarisk Member of the Rustler Formation. From 685 ft to the casing point at approximately 735 ft, the hole should be cored using the wireline-coring assembly. This coring can be done using either brine or air as the circulation medium. After the hole is cased, the remainder of the hole to approximately 785 ft (T.D.) is to be cored with air. The interval below the casing will then have to be reamed using the 5 $\frac{1}{8}$ -inch bit so that the hole is the same size as H-19b2, 3, and 4.

To stabilize the hole below the Culebra dolomite, we want the drillers to install 5 $\frac{1}{2}$ -inch Centron DHC300 casing in the bottom of the hole. This casing should be cut to exactly the length that the hole continues past the base of the Culebra. This casing should be installed as soon as the drillers complete reaming of the hole to T.D. The casing will not be cemented in place; we will simply allow the clay to squeeze around it. To get the casing to the bottom of the hole, a packer should be inflated inside the casing at the surface, and then the packer (and casing) will be lowered in the hole on 2 $\frac{3}{8}$ -inch tubing. If the hole caves in before the casing can get to bottom, we will determine how deep we can get and then decide whether to: (1) pull out, clean out the hole, and try again; (2) pull out, cut a portion of the casing off, and run it back in; (3) release the casing and remove the packer, and then run in with the bit (or something else wider than the casing) and attempt to push the casing down; or (4) something else. If we are successful with this operation, we will likely do it also in H-19b2 through 6. To this end, please immediately order six 29-ft joints of the 5 $\frac{1}{2}$ -inch Centron DHC300 casing. The cost should be low enough for Martha to be able to place the order.

Please contact me if you have any questions about these directions.

cc: A.R. Sattler, 6111, MS0706 C.S. Chocas, 6115, MS1324
P.B. Davies, 6115, MS1324 J.W. Mercer, 9333, MS1156
A.R. Lappin, 6115, MS1324 M.B. Kloska, INTERA
L.C. Meigs, 6115, MS1324 W.A. Stensrud, INTERA, WIPP
SWCF-A:1.1.5.3.4:FOP:QA:H-19 well locations

H-19 Well Locations

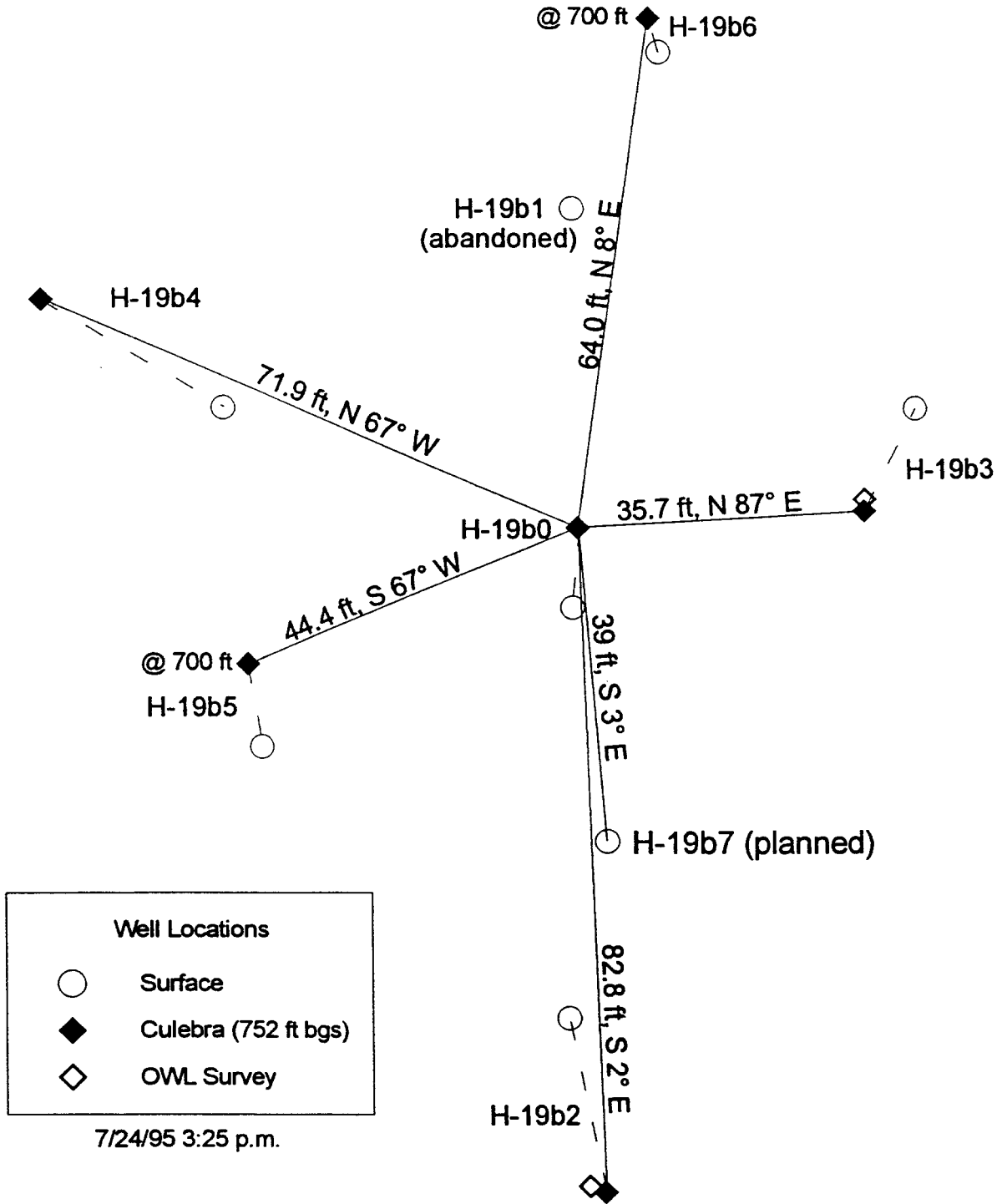

APPENDIX B

Abridged Hole Histories

Page intentionally left blank.

HYDROLOGIC DRILLHOLE H-19b0 ABRIDGED HOLE HISTORY

NOTE: All depths are measured from ground level.

The following hole history was abstracted from Sandia National Laboratories' daily drilling records. Drillhole H-19b0 is a replacement hole for drillhole H-19b1 which was abandoned because unrecoverable tools were stuck in the hole. Tailgate safety meetings were held each day prior to beginning operations.

3-28-95 Rigged up Water Development rig, Dresser T70W over 20-inch surface casing at H-19b0 location; established depth control for well (v-notch cut in surface casing). Set up mud pumps and shale shaker. Made up drilling assembly consisting of a 12.25-inch tricone bit and tripped in hole to bottom of surface casing at 38 ft. Broke tower at 1450 hr, began drilling 12.25-inch hole using saturated brine as drilling fluid. Drilled to 70 ft; circulated hole clean and tripped out drill pipe. Secured site at 1730 hr.

3-29-95 Made up new drilling assembly by adding collars to string. Tripped in to 70 ft; circulated hole and began drilling 12.25-inch hole at 1100 hr. Drilled from 70 ft to 134 ft; circulated hole and tripped out drill pipe to collars. Site secured at 1750 hr.

3-30-95 Trip in hole with drill pipe to 134 ft; circulated hole with saturated brine water and salt gel. Continued drilling 12.25-inch hole from 134 ft to 248 ft. Some problems with mud. Circulated hole and tripped out to collars. Site secured at 1815 hr.

3-31-95 Decided to change out drilling fluid and mix salt gel with saturated brine water. Conducted routine rig maintenance. Tripped in to 248 ft and continued drilling; still having penetration problems. Drilled to 260 ft and circulated hole for several hours. Pulled back to collars and secured site at 1810 hr.

4-01-95 Tripped in with drill pipe and circulated and reamed back to bottom at 260 ft. Continued drilling 12.25-inch hole from 260 ft to 343 ft using saturated brine and salt gel. Circulated hole and pulled back to collars. Site secured at 1645 hr.

4-02-95 Run in hole with drill pipe and circulated hole; very little fill. Continued drilling from 343 ft to 508 ft using saturated brine and salt gel as drilling fluid. Addition of mud pump increased mud volume and increased penetration rate. Circulated hole and tripped out drill pipe to collars. Site secured at 1745 hr.

4-03-95 Tripped in hole; encountered little fill. Continued drilling 12.25-inch hole from 508 ft to 601 ft. Drilling fluid continued to consist of saturated brine and salt gel. Circulated hole and tripped out drill pipe to collars and secured site at 1900 hr.

4-04-95 Put liners in mud pump. Tripped in drill pipe and continued drilling from 601 ft to 679 ft. Circulated hole and tripped out drill pipe to collars. Site secured at 1700 hr.

4-05-95 Tripped in drill pipe and continued drilling 12.25-inch hole from 679 ft to 728 ft, which is point in hole that drilling the 12.25-inch hole ended. Will rig up to ream hole. Circulated hole and tripped out drill pipe, collars, and bit. Site secured at 1915 hr.

logs on cored interval. Logged to 778.2 ft. Rigged down USGS at 1630 hr. Demobilized rig from H-19b0. Secured site at 1800 hr.

Operations associated with drilling completed on H-19b0.

HYDROLOGIC DRILLHOLE H-19b0 ABRIDGED HOLE HISTORY

NOTE: All depths are measured from ground level.

The following hole history was abstracted from Sandia National Laboratories' daily drilling records. Drillhole H-19b0 is a replacement hole for drillhole H-19b1 which was abandoned because unrecoverable tools were stuck in the hole. Tailgate safety meetings were held each day prior to beginning operations.

3-28-95 Rigged up Water Development rig, Dresser T70W over 20-inch surface casing at H-19b0 location; established depth control for well (v-notch cut in surface casing). Set up mud pumps and shale shaker. Made up drilling assembly consisting of a 12.25-inch tricone bit and tripped in hole to bottom of surface casing at 38 ft. Broke tower at 1450 hr, began drilling 12.25-inch hole using saturated brine as drilling fluid. Drilled to 70 ft; circulated hole clean and tripped out drill pipe. Secured site at 1730 hr.

3-29-95 Made up new drilling assembly by adding collars to string. Tripped in to 70 ft; circulated hole and began drilling 12.25-inch hole at 1100 hr. Drilled from 70 ft to 134 ft; circulated hole and tripped out drill pipe to collars. Site secured at 1750 hr.

3-30-95 Trip in hole with drill pipe to 134 ft; circulated hole with saturated brine water and salt gel. Continued drilling 12.25-inch hole from 134 ft to 248 ft. Some problems with mud. Circulated hole and tripped out to collars. Site secured at 1815 hr.

3-31-95 Decided to change out drilling fluid and mix salt gel with saturated brine water. Conducted routine rig maintenance. Tripped in to 248 ft and continued drilling; still having penetration problems. Drilled to 260 ft and circulated hole for several hours. Pulled back to collars and secured site at 1810 hr.

4-01-95 Tripped in with drill pipe and circulated and reamed back to bottom at 260 ft. Continued drilling 12.25-inch hole from 260 ft to 343 ft using saturated brine and salt gel. Circulated hole and pulled back to collars. Site secured at 1645 hr.

4-02-95 Run in hole with drill pipe and circulated hole; very little fill. Continued drilling from 343 ft to 508 ft using saturated brine and salt gel as drilling fluid. Addition of mud pump increased mud volume and increased penetration rate. Circulated hole and tripped out drill pipe to collars. Site secured at 1745 hr.

4-03-95 Tripped in hole; encountered little fill. Continued drilling 12.25-inch hole from 508 ft to 601 ft. Drilling fluid continued to consist of saturated brine and salt gel. Circulated hole and tripped out drill pipe to collars and secured site at 1900 hr.

4-04-95 Put liners in mud pump. Tripped in drill pipe and continued drilling from 601 ft to 679 ft. Circulated hole and tripped out drill pipe to collars. Site secured at 1700 hr.

4-05-95 Tripped in drill pipe and continued drilling 12.25-inch hole from 679 ft to 728 ft, which is point in hole that drilling the 12.25-inch hole ended. Will rig up to ream hole. Circulated hole and tripped out drill pipe, collars, and bit. Site secured at 1915 hr.

4-06-95 Rigged up hole opener to ream 12.25-inch hole to 14.75 inches. Tripped in hole with reaming assembly to 37 ft. Began reaming operation using saturated brine water with salt gel. Reamed hole from 37 ft to 283 ft; circulated hole and tripped out drill pipe to collars. Worked on mud pump. Site secured at 2030 hr.

4-07-95 Tripped in the hole with drill pipe and circulated the hole of cuttings (fill) that had settled out. Continued reaming the drillhole to 14.75 inches from 283 ft to 572 ft using brine water with salt gel as drilling fluid. Circulated hole and tripped out drill pipe to collars. Site secured at 1740 hr.

4-08-95 Tripped in the hole with drill pipe and circulated hole. Continued reaming 12.25-inch hole to 14.75 inches from 572 ft to casing depth of 735.5 ft. Circulated hole clean and tripped out drill pipe to collars. Site secured at 1945 hr.

4-09-95 Tripped in drill pipe and circulated hole in preparation for geophysical logging. Only 2 ft of fill on bottom. Tripped out of hole with drill pipe, collars, and hole opener. U.S. Geological Survey geophysical loggers on site at 1420 hr. Rigged up loggers and ran natural gamma, neutron porosity, and caliper logs to total depth. Rigged down U.S. Geological Survey at 1715 hr. Notified State Engineer's office and cementers of plans to run casing and cement the well tomorrow. Site secured at 1730 hr.

4-10-95 Inspected and tallied 27 joints of Centron DHC 350, 9.12-inch, 8.7 lb/ft fiberglass casing. Placed a combination guide shoe-float collar on bottom of first joint. Rigged up and ran 27 joints of casing setting the bottom of guide shoe at 731.9 ft. Centralizers were placed on the top of guide shoe-float collar and on top of casing joints numbers 1, 4, 8, 11, 14, 20, and 24. Western Cementing company on site at 1430 hr. Western rigged up circulation head and broke circulation. Commenced cementing operations at 1605 hr and pumped a slurry that included 70–30% pozzolan cement with 5% salt, 2% bentonite followed by a tail cement slurry consisting of Class C cement with 2% calcium chloride. Plug dropped and pumped down and cementing head was shut in at 1720 hr. About 127 sacks of cement were circulated to the surface and put in the pits. Rigged down Western and secured the site at 1930 hr.

4-11-95 Wait on cement. Rig maintenance. Site secured at 1705 hr.

4-12-95 Rigged up to drill out cement. Tripped in drill pipe and 7.875-inch tricone bit and displaced brine in casing with Culebra water pumped from WQSP-4. Tagged top of cement and fill at 685 ft. Began drill out of cement in casing. Drilled out cement and formation to core point at 736.7 ft. Changed out drilling fluid contaminated with cement with Culebra water. Secured site at 1730 hr.

4-13-95 Tripped out drill pipe and 7.875-inch bit. Rigged up Christensen-Boyles coring equipment. Site secured at 1200 hr for days off.

4-14-95 No drilling activity. Crew on break.

4-15-95 No drilling activity. Crew on break.

4-16-95 No drilling activity. Crew on break.

4-17-95 No drilling activity. Crew on break.

4-18-95 No drilling activity. Crew on break.

4-19-95 Finished rigging up coring equipment. Core barrel is a 5-ft Christensen-Boyles conventional barrel with a split inner barrel. The coring assembly is configured to cut 7.75-inch hole and take a 5.875-inch core. Tripped in hole with coring assembly and drill pipe to coring depth of 736.7 ft. Circulated hole with Culebra water as coring fluid. Began trial runs at 1131 hr and cut core from 736.7 ft to 739.2 ft. Core cut very slow, questioned possibility of having “junk” in hole. Tripped out of hole with coring assembly and drill pipe. Recovered 2.5 ft of core and found pieces of metal on core bit. Tripped in hole with 7.875-inch tricone bit to clean out hole. Mixed up bentonite slug to “sweep” hole. Circulated hole. Site secured at 1830 hr.

4-20-95 Drilled about one ft of formation to see whether any “junk” drilled up. Tripped out drill pipe and 7.875- inch bit. Rigged up and tripped in drill pipe and conventional Christensen-Boyles core barrel (7.75-inch bit to cut 5.875-inch core). Tagged bottom of hole at 740.3 ft. Circulated hole and changed out drilling fluid with new Culebra water. Cored trial run from 740.3 ft to 740.8 ft and core barrel pressured up. Tripped out core barrel and recovered 0.5 ft of core. Top of Culebra at 740.1 ft. Problems with inner barrel unscrewing. Called Christensen and found out misinformation in operations manual; made changes and tripped in hole with core barrel and drill pipe. Cored run #1 from 740.8 ft to 745.8 ft. Tripped out drill pipe and core barrel recovering 5.0 ft of core (100%). Changed out speed drive on head. Site secured at 1815 hr.

4-21-95 Rigged up core barrel and added collars to drill string for extra weight. Tripped in hole to coring depth at 745.8 ft and circulated hole. Cored run #2 from 745.8 ft to 750.8 ft. Circulated hole and tripped out of hole with drill pipe and core barrel recovering 5.0 ft of core (100%). Redress core barrel and tripped in and cut core #3 from 750.8 ft to 755.8 ft. Circulated hole and tripped out with core barrel recovering 5.0 ft of core (100%). Tripped in with core barrel and drill pipe and cut core #4 from 755.8 ft to 760.8 ft where core barrel pressured up. Circulated hole. Tripped out with drill pipe and core barrel recovering 4.6 ft of core (92%). Redressed core barrel and run in hole to bottom of casing. Secured site at 1815 hr.

4-22-95 Tripped to bottom with core barrel to continue coring. Cut core #5 from 760.8 ft to 765.2 ft when core barrel blocked off. Circulated hole and tripped out with core barrel recovering 3.6 ft of core (82%). Hit the contact between the Culebra Dolomite Member and the unnamed lower member of the Rustler Formation at 764.4 ft. Redressed core barrel and tripped in hole. Cored run #6 from 765.2 ft to 770.2 ft and circulated the hole. Tripped out core barrel, no recovery as core evidently slid out of barrel. Redressed core barrel checking out core catcher and tripped back in the hole to try to recover core. Cored an extra 1.0 ft. Tripped out core barrel, evidently catcher not holding and no core was recovered. Redressed core barrel and tripped in hole to bottom of casing. Secured site at 1730 hr.

4-23-95 Tripped coring assembly to a depth of 771.2 ft and circulated the hole using Culebra water for coring fluid. Cored run #7 from 771.2 ft to 773.7 ft and circulated the hole. Tripped out coring assembly and recovered 4.4 ft core; however, unable to determine where core came from as there was probably excess core from previous runs. Redressed core barrel and tripped in the hole and cut core #8 from 773.7 ft to 778.7 ft. Circulated the hole and tripped out core barrel recovering 4.9 ft of core. U.S. Geological Survey on site at 1400 hr to run geophysical logs. Rigged up loggers and ran natural gamma, gamma-gamma density, neutron porosity, and caliper

logs on cored interval. Logged to 778.2 ft. Rigged down USGS at 1630 hr. Demobilized rig from H-19b0. Secured site at 1800 hr.

Operations associated with drilling completed on H-19b0.

HYDROLOGIC DRILLHOLE H-19b1 ABRIDGED HOLE HISTORY

NOTE: All depths are measured from ground level.

The following hole history was abstracted from Sandia National Laboratories' daily drilling records. Tailgate safety meetings were held each day prior to beginning operations.

2-13-95 Rigged up Water Development Dresser T70W drilling rig over the 20-inch surface casing at H-19b1. Set temporary 6.625-inch protective casing inside the surface casing in preparation for coring. Made up Christensen-Boyles wireline coring assembly with a 4.835-inch-diameter diamond coring bit to cut 3.345-inch-diameter core. Held "kickoff" meeting and an inspection by Westinghouse safety was conducted. Secured operations at 1845 hr.

2-14-95 Picked up wireline coring assembly and wireline coring pipe and tripped in hole. The coring assembly was made up of a 5-ft core barrel with a split inner tube. The hole was cleaned out to 36.8 ft using compressed air as a circulation fluid. Rigged up and cut core #1 (using air as coring fluid) from 36.8 ft to 41.8 ft and recovered 5.0 ft of core (100%). Cut core #2 from 41.8 ft to 46.8 ft and recovered 5.0 ft of core (100%). Cut core #3 from 46.8 ft to 51.8 ft and recovered 5.0 ft (100%). Cut core # 4 from 51.8 ft to 56.8 ft and recovered 4.9 ft of core (98%). Cut core #5 from 56.8 ft to 61.6 ft and recovered 4.8 ft of core (100%). Cut core #6 from 61.6 ft to 66.6 ft and recovered 4.3 ft of core (86%). Cut core #7 from 66.6 ft to 71.6 ft and recovered 4.9 ft core (98%). Cut core #8 from 71.6 ft to 76.6 ft and recovered 5.0 ft core (100%). Cut core #9 from 76.6 ft to 81.6 ft and recovered 5.0 ft core (100%). Cut core #10 from 81.6 ft to 86.6 ft and recovered 4.9 ft of core (98%). Cut core #11 from 86.6 ft to 91.6 ft and recovered 5.0 ft core (100%). Cut core #12 from 91.6 ft to 96.6 ft and recovered 5.0 ft of core (100%). Cut core #13 from 96.6 ft to 101.6 ft and recovered 5.0 ft of core (100%). Cut core #14 from 101.6 ft to 106.6 ft and recovered 4.5 ft of core (90%). Cut core #15 from 106.6 ft to 111.6 ft and recovered 4.8 ft of core (96%). Cut core #16 from 111.6 ft to 116.6 ft and recovered 5.0 ft of core (100%). Cut core #17 from 116.6 ft to 121.6 ft and recovered 4.5 ft of core (90%). Circulated hole clean and conducted maintenance on rig. Site secured at 1830 hr.

2-15-95 Circulated hole with air and continued wireline coring operation. Cut core #18 from 121.6 ft to 126.6 ft and recovered 4.9 ft of core (98%). Cut core #19 from 126.6 ft to 131.6 ft and recovered 5.0 ft of core (100%). Cut core #20 from 131.6 ft to 136.6 ft and recovered 5.0 ft of core (100%). Cut core # 21 from 136.6 ft to 141.6 ft and recovered 5.0 ft of core (100%). Cut core #22 from 141.6 ft to 146.6 ft and recovered 4.9 ft of core (98%). Cut core #23 from 146.6 ft to 151.6 ft and recovered 5.0 ft of core (100%). Cut core #24 from 151.6 ft to 156.6 ft and recovered 4.9 ft core (98%). Cut core #25 from 156.6 ft to 161.6 ft and recovered 5.0 ft core (100%). Cut core #26 from 161.6 ft to 164.0 ft and recovered 2.4 ft core (100%). Cut core #27 from 164.0 ft to 169.0 ft and recovered 4.8 ft of core (96%). Cut core #28 from 169.0 ft to 174.0 ft and recovered 5.0 ft core (100%). Cut core #29 from 174.0 ft to 179.0 ft and recovered 5.0 ft of core (100%). Cut core #30 from 179.0 ft to 184.0 ft and recovered 2.2 ft of core (44%). Hit a very sandy zone. Cut core #31 from 184.0 ft to 188.0 ft and recovered 2.7 ft of core (68%). Cut core # 32 from 188.0 ft to 193.0 ft and recovered 4.0 ft (80%). Cut core # 33 from 193.0 ft to 198.0 ft and recovered 4.4 ft of core (88%). Problems with air bypassing seal around annulus. Worked on seal. Trip out wireline pipe and coring assembly. Site secured at 1825 hr.

2-16-95 Picked up Christensen-Boyles wireline coring assembly and tripped in the hole to continue wireline coring operation. Circulated hole using air-mist. Cut core #34 from 198.0 ft to 203.0 ft and recovered 5.0 ft of core (100%). Cut core #35 from 203.0 ft to 208.0 ft and recovered 5.0 ft of core (100%). Cut core #36 from 208.0 ft to 213.0 ft and recovered 5.0 ft of core (100%). Cut core #37 from 213.0 ft to 218.0 ft and recovered 5.0 ft of core (100%). Cut core #38 from 218.0 ft to 223.0 ft and recovered 5.0 ft of core (100%). Cut core #39 from 223.0 ft to 228.0 ft and recovered 5.0 ft of core (100%). Cut core #40 from 228.0 ft to 233.0 ft and recovered 5.0 ft of core (100%). Cut core # 41 from 233.0 ft to 238.0 ft and recovered 5.0 ft of core (100%). Cut core #42 from 238.0 ft to 243.0 ft and recovered 5.0 ft core (100%). Cut core #43 from 243.0 ft to 248.0 ft and recovered 5.0 ft core (100%). Cut core #44 from 248.0 ft to 253.0 ft and recovered 4.9 ft core (98%). Cut core #45 from 253.0 ft to 258.0 ft and recovered 5.0 ft of core (100%). Cut core #46 from 258.0 ft to 263.0 ft and recovered 5.0 ft core (100%). Cut core #47 from 263.0 ft to 268.0 ft and recovered 5.0 ft of core (100%). Cut core #48 from 268.0 ft to 273.0 ft and recovered 5.0 ft of core (100%). Cut core #49 from 273.0 ft to 278.0 ft and recovered 5.0 ft of core (100%). Cut core # 50 from 278.0 ft to 283.0 ft and recovered 5.0 ft of core (100%). Cut core # 51 from 283.0 ft to 288.0 ft and recovered 5.0 ft of core (100%). Cut core #52 from 288.0 ft to 293.0 ft and recovered 5.0 ft of core (100%). Cut core #53 from 293.0 ft to 298.0 ft and recovered 5.0 ft of core (100%). Circulated hole. Site secured at 1730 hr.

2-17-95 Circulated hole using air-mist. Continued wireline coring operation. Cut core 54 from 298.0 ft to 303.0 ft and recovered 5.0 ft of core (100%). Cut core # 55 from 303.0 ft to 308.0 ft and recovered 5.0 ft of core (100%). Cut core #56 from 308.0 ft to 313.0 ft and recovered 5.0 ft of core (100%). Cut core #57 from 313.0 ft to 318.0 ft and recovered 5.0 ft of core (100%). Cut core #58 from 318.0 ft to 323.0 ft and recovered 5.0 ft of core (100%). Cut core #59 from 323.0 ft to 328.0 ft and recovered 5.0 ft of core (100%). Cut core #60 from 328.0 ft to 333.0 ft and recovered 5.0 ft of core (100%). Cut core #61 from 333.0 ft to 338.0 ft and recovered 5.0 ft of core (100%). Cut core #62 from 338.0 ft to 343.0 ft and recovered 5.0 ft core (100%). Cut core # 63 from 343.0 ft to 348.0 ft and recovered 5.0 ft core (100%). Cut core #64 from 348.0 ft to 353.0 ft and recovered 5.0 ft core (100%). Cut core #65 from 353.0 ft to 358.0 ft and recovered 5.0 ft of core (100%). Cut core #66 from 358.0 ft to 363.0 ft and recovered 5.0 ft core (100%). Cut core #67 from 363.0 ft to 368.0 ft and recovered 5.0 ft of core (100%). Cut core #68 from 368.0 ft to 373.0 ft and recovered 5.0 ft of core (100%). Cut core #69 from 373.0 ft to 378.0 ft and recovered 5.0 ft of core (100%). Cut core #70 from 378.0 ft to 383.0 ft and recovered 5.0 ft of core (100%). Cut core #71 from 383.0 ft to 388.0 ft and recovered 5.0 ft of core (100%). Circulated hole with air-mist. Site secured at 1745 hr.

2-18-95 Circulated hole using air-mist. Continued wireline coring operation. Cut core #72 from 388.0 ft to 393.0 ft and recovered 5.0 ft of core (100%). Cut core #73 from 393.0 ft to 398.0 ft and recovered 5.0 ft of core (100%). Cut core #74 from 398.0 ft to 403.0 ft and recovered 5.0 ft of core (100%). Cut core #75 from 403.0 ft to 408.0 ft and recovered 5.0 ft of core (100%). Cut core #76 from 408.0 ft to 413.0 ft and recovered 5.0 ft of core (100%). Cut core #77 from 413.0 ft to 418.0 ft and recovered 5.0 ft of core (100%). Cut core #78 from 418.0 ft to 423.0 ft and recovered 5.0 ft of core (100%). Cut core #79 from 423.0 ft to 428.0 ft and recovered 5.0 ft of core (100%). Cut core # 80 from 428.0 ft to 433.0 ft and recovered 5.0 ft of core (100%). Cut core #81 from 433.0 ft to 438.0 ft and recovered 5.0 ft of core (100%). Cut core #82 from 438.0 ft to 443.0 ft and recovered 5.0 ft of core (100%). Cut core #83 from

443.0 ft to 448.0 ft and recovered 5.0 ft of core (100%). Cut core #84 from 448.0 ft to 453.0 ft and recovered 5.0 ft of core (100%). Cut core #85 from 453.0 ft to 458.0 ft and recovered 5.0 ft of core (100%). Cut core #86 from 458.0 ft to 463.0 ft and recovered 5.0 ft core (100%). Cut core #87 from 463.0 ft to 468.0 ft and recovered 5.0 ft of core (100%). Problems with air valve on wireline reel; repaired. Circulated hole with air-mist. Site secured at 1710 hr.

2-19-95 Circulated hole using air-mist. Continued wireline coring operation. Cut core #88 from 468.0 ft to 473.0 ft and recovered 5.0 ft of core (100%). Cut core #89 from 473.0 ft to 478.0 ft and recovered 5.0 ft of core (100%). Cut core #90 from 478.0 ft to 483.0 ft and recovered 5.0 ft of core (100%). Cut core #91 from 483.0 ft to 488.0 ft and recovered 5.0 ft of core (100%). Cut core #92 from 488.0 ft to 493.0 ft and recovered 5.0 ft of core (100%). Cut core #93 from 493.0 ft to 498.0 ft and recovered 5.0 ft of core (100%). Cut core #94 from 498.0 ft to 503.0 ft and recovered 5.0 ft of core (100%). Cut core #95 from 503.0 ft to 508.0 ft and recovered 5.0 ft of core (100%). Cut core #96 from 508.0 ft to 513.0 ft and recovered 5.0 ft of core (100%). Cut core #97 from 513.0 ft to 518.0 ft and recovered 5.0 ft of core (100%). Continued having problems with air valve on sand line; repaired. Circulated hole. Site secured at 1700 hr.

2-20-95 Circulated hole using air-mist. Continued wireline coring operation using Christensen-Boyles wireline coring assembly with a 4.835-inch-diameter diamond coring bit to cut 3.345-inch-diameter core. Cut core #98 from 518.0 ft to 523.0 ft and recovered 5.0 ft of core (100%). Cut core #99 from 523.0 ft to 528.0 ft and recovered 5.0 ft of core (100%). Cut core #100 from 528.0 ft to 533.0 ft and recovered 5.0 ft of core (100%). Cut core #101 from 533.0 ft to 538.0 ft and recovered 5.0 ft of core (100%). Cut core #102 from 538.0 ft to 543.0 ft and recovered 5.0 ft of core (100%). Cut core #103 from 543.0 ft to 548.0 ft and recovered 5.0 ft of core (100%). Cut core #104 from 548.0 ft to 553.0 ft and recovered 5.0 ft of core (100%). Cut core #105 from 553.0 ft to 558.0 ft and recovered 5.0 ft of core (100%). Cut core #106 from 558.0 ft to 563.0 ft and recovered 5.0 ft of core (100%). Cut core #107 from 563.0 ft to 568.0 ft and recovered 5.0 ft of core (100%). Hit top of Rustler Formation at 566.5 ft. Cut core #108 from 568.0 ft to 573.0 ft and recovered 5.0 ft of core (100%). Cut core #109 from 573.0 ft to 578.0 ft and recovered 5.0 ft of core (100%). Cut core #110 from 578.0 ft to 583.0 ft and recovered 5.0 ft of core (100%). Cut core #111 from 583.0 ft to 588.0 ft and recovered 5.0 ft of core (100%). Cut core #112 from 588.0 ft to 593.0 ft and recovered 5.0 ft of core (100%). Cut core #113 from 593.0 ft to 598.0 ft and recovered 5.0 ft of core (100%). Cut core #114 from 598.0 ft to 603.0 ft and recovered 2.5 ft of core (50%). Circulated hole. Tripped out wireline pipe and coring assembly. Site secured at 1800 hr.

2-21-95 Lined up equipment to conduct hydrologic tests on the Magenta. Tallied 2.375-inch tubing. Changed out sand line on rig. Rig on standby. Site secured at 1730 hr.

2-22-95 Tripped in Christensen-Boyles wireline coring assembly (a 4.835-inch-diameter diamond coring bit to cut 3.345-inch-diameter core) and wireline pipe. Circulated hole using air. Continued wireline coring operation. Cut core #115 from 603.0 ft to 608.0 ft and recovered 5.0 ft of core (100%). Cut core #116 from 608.0 ft to 613.0 ft and recovered 5.0 ft of core (100%). Cut core #117 from 613.0 ft to 618.0 ft and recovered 5.0 ft of core (100%). Cut core #118 from 618.0 ft to 623.0 ft and recovered 5.0 ft of core (100%). Cut core #119 from 623.0 ft to 628.0 ft and recovered 5.0 ft of core (100%). Cut core #120 from 628.0 ft to 633.0 ft and recovered 4.4 ft of core (88%). Cut core #121 from 633.0 ft to 638.0 ft and recovered 2.2 ft of

core (44%). Clay causing barrel to block off. Cut core #122 from 638.0 ft to 642.6 ft where barrel blocked off. Recovered 4.6 ft of core (100%). Cut core # 123 from 642.6 ft to 647.6 ft and recovered 5.0 ft of core (100%). Cut core #124 from 647.6 ft to 651.6 ft and recovered 4.0 ft of core (100%). Ended coring operation to run hydrologic tests on the Magenta Member of the Rustler Formation. Hole depth 651.6 ft. Circulated hole using air. Site secured at 1840 hr.

2-23-95 Checked the water level in the well with Solinist meter and found water level at 377.89 ft. Tripped out wireline pipe and coring assembly. Rigged up to run a temporary packer on 2.375-inch tubing. Ran in hole with packer, set, and inflated the packer just above the Magenta. Drilling operations ended, crew on days off.

2-24-95 No drilling activity. Crew on break.

2-25-95 No drilling activity. Crew on break.

2-26-95 No drilling activity. Crew on break.

2-27-95 No drilling activity. Crew on break.

2-28-95 No drilling activity. Crew on break.

3-01-95 Rigged up and deflated temporary packer. Tripped out 2.375-inch tubing and packer. Rigged up test packer with pressure transducers. Tripped in hole with test assembly and set and inflated packer to test the Magenta. Bailed hole and put well on test status. Site secured at 1815 hr.

3-02-95 Well on test. Ran a series of shut-in and flow tests. Site secured at 1800 hr.

3-03-95 Well on test. Continued flow and shut-in tests. Site secured at 1755 hr.

3-04-95 Terminated hydrologic testing of the Magenta. Deflated the packer and tripped the testing assembly out of the hole. Rigged down the test equipment. Rigged up the Christensen-Boyles wireline coring system (a 4.835-inch-diameter diamond coring bit to cut 3.345-inch diameter core) and tripped the assembly in the hole on the wireline pipe. Converted from air coring to coring with saturated brine as a circulation fluid. Rigged up "shaker," mud pumps, and ancillary equipment. Site secured at 1800 hr.

3-05-95 Finished rigging up coring equipment. Tripped in hole, "broke circulation" using saturated brine as coring fluid and circulated wireline pipe in hole to coring depth of 651.6 ft. Dropped inner barrel to continue coring using Christensen-Boyles wireline coring system cutting 3.345-inch core. Cut core #125 from 651.6 ft to 654.6 ft and recovered 2.8 ft of core (93%). Cut core #126 from 654.6 ft to 659.6 ft and recovered 4.8 ft of core (96%). Cut core #127 from 659.6 ft to 664.6 ft and recovered 5.0 ft of core (100%). Cut core #128 from 664.6 ft to 669.6 ft and recovered 5.0 ft of core (100%). Cut core #129 from 669.6 ft to 674.6 ft and recovered 3.5 ft of core (70%). Problems holding core in inner barrel. Circulated hole using saturated brine water as coring fluid. Site secured at 1750 hr.

3-06-95 Circulated hole using brine water; tripped in with inner core barrel. Continued wireline coring operation. Cut core #130 from 674.6 ft to 677.6 ft and recovered 2.9 ft of new core. Also recovered remainder of core from previous run (run #129). Cut core # 131 from 677.6 ft to 682.6 ft and recovered 5.0 ft of core (100%). Cut core #132 from 682.6 ft to 687.6 ft and recovered 5.0 ft of core (100%). Cut core #133 from 687.6 ft to 692.6 ft and recovered 5.0 ft of core (100%). Cut core #134 from 692.6 ft to 697.6 ft and recovered 4.8 ft of core (96%). Cut

core #135 from 697.6 ft to 702.6 ft and recovered 5.0 ft of core (100%). Cut core #136 from 702.6 ft to 707.6 ft and recovered 5.0 ft of core (100%). Cut core #137 from 707.6 ft to 712.6 ft and recovered 5.0 ft of core (100%). Cut core #138 from 712.6 ft to 717.6 ft and recovered 5.0 ft of core (100%). Cut core # 139 from 717.6 ft to 722.6 ft and recovered 5.0 ft of core (100%). Circulated hole using saturated brine water. Secured site.

3-07-95 Circulated hole in preparation for continued coring operation. Cut core # 140 from 722.6 ft to 727.6 ft using saturated brine water as coring fluid. Recovered 5.0 ft of core (100%). Cut core #141 from 727.6 ft to 732.6 ft and recovered 5.0 ft of core (100%). Reached casing point at 732.6 ft; circulated hole clean and tripped out with wireline pipe and coring assembly. U.S. Geological Survey geophysical logging truck on site. Rigged up to run logs; logging commenced at 1315 hr. Geophysical logs run included gamma ray, neutron porosity, gamma-gamma density. Problem with the caliper module; caliper log was not run. USGS completed logging at 1735 hr. Rigged down USGS and secured site at 1930 hr.

3-08-95 Rigged up 12.25-inch reaming assembly. Picked up collars and tripped in the hole to 44 ft. Reaming 4.835-inch core hole to 12.25-inch hole using saturated brine water as drilling fluid. Swivel packing leaking; repaired. Reamed hole to 90 ft. Circulated hole. Site secured at 1800 hr.

3-09-95 Worked on seal around mud tub near annulus of drillhole. Picked up additional collars and tripped in hole. Circulated to bottom of hole at 90 ft. Continued reaming core hole to 12.25 inches. Reamed hole from 90 ft to 200 ft. Conducted routine maintenance on rig. Secured site at 1740 hr.

3-10-95 Circulated hole cleaning out cuttings that had settled out of drilling mud. Repaired packing on mud pump. Continued reaming hole to 12.25 inches from 200 ft to 244 ft. Problems with condition of mud and bit. Penetration rate quite low. Will trip out bit and change tomorrow. Circulated hole clean and pulled back drill pipe to the collars. Site secured at 1750 hr.

3-11-95 Finished tripping out drill pipe, collars, and bit. Changed out bit to long-toothed tricone. Tripped in new bit, drill pipe, and collars to 237 ft. Encountered fill, circulated hole and continued reaming hole to 283 ft. Worked on adding an additional mud pump in the system to increase volume. Added stabilizer to tool string. Circulated hole and pulled back drill pipe to collars. Site secured at 1750 hr.

3-12-95 Tripped in drill pipe to 283 ft and circulated hole. Continued reaming hole using saturated brine with salt gel. Reamed hole to 12.25 inches from 283 ft to 380 ft. Changed out and conditioned new drilling fluid. Pulled back to collars. Site secured at 1810 hr.

3-13-95 Tripped in drill pipe and bit to 380 ft and circulated hole with saturated brine. Continued reaming hole to 12.25 inches. Reamed from 380 ft to 441 ft. Still having problems with penetration rate. Bit appears to be "balling" up. Decided to change out jets on bit. Tripped out drill pipe, collars, and bit assembly. Site secured at 1910 hr.

3-14-95 Put new jets in the bit. Tripped in drill pipe, collars, and bit assembly, tagged fill about 60 ft off bottom; circulated hole down to 441 ft. Continued reaming from 441 ft to 567 ft. Bit jet changes increased volume and thus penetration rate. Circulated hole and tripped back drill pipe to collars. Site secured at 1845 hr.

3-15-95 Tripped in drill pipe to 567 ft. Thinned down mud. Continued reaming hole to 12.25 inches from 567 ft to 658 ft when drill pipe broke off at tool joint. Hole depth at 658 ft and top of collars approximately 454 ft below ground level. Called fishing company to line up necessary equipment to try and retrieve tools. Site secured at 1800 hr.

3-16-95 Star Tool on site to rig up overshot and grapple to “fish” for lost tools. Tripped in hole and tagged “fish” at 454 ft. Several attempts were made but unable to latch on to tools. Tripped out and replaced grapple with larger size. Tripped back in hole and attempted to latch on to “fish.” Tried to circulate and wash over tools. Unable to do so; tripped out and rigged down overshot and grapple. Site secured at 1816 hr.

3-17-95 Star Tool on site to continue “fishing” operations. Continued to try different sized overshots and grapples; still unable to latch on to tools. Site secured at 1800 hr.

3-18-95 Continued “fishing” operations. Finally latched on to “fish.” Called Rotary Wireline to run “freepoint.” Baker float in collars will not let freepoint tool past. Decided to “shoot off” drill pipe at top of collars. After drill pipe was loose, tripped out. Rigged up jars and accelerator with collars. Ready to run in hole tomorrow. Site secured at 1900 hr.

3-19-95 Picked up fishing equipment and tripped in hole. Tagged top of collars (fish) at 573 ft. Circulated hole and screwed into top of “fish.” Worked pipe and tripped jar; moved fish only about two inches. Continued to work pipe although did not make much headway. Decided at point of diminishing returns so it was decided the hole (H-19b1) would be temporarily abandoned. Called Rotary Wireline to shoot “fish” loose from jars. Pipe was shot off and fishing tools were tripped out. Will conduct meeting tomorrow on hole abandonment. Site secured at 1930 hr.

3-20-95 Tripped out drill pipe and fishing tools. Teleconference with Beauheim resulted in a decision to abandon hole H-19b1. Rigged down and cleaned up site. New location was picked. Secured site at 1730 hr.

Operations associated with drilling completed when hole was abandoned.

HYDROLOGIC DRILLHOLE H-19b2 ABRIDGED HOLE HISTORY

The following hole history was abstracted from Sandia National Laboratories' daily drilling records. Tailgate safety meetings were held each day prior to beginning operations.

NOTE: All depths are measured from ground level.

5-10-95 Rigged up Water Development rig Dresser T70W over 14-inch surface casing at H-19b2 location; established depth control for well (v-notch cut in surface casing). Set up mud pumps and shale shaker. Made up drilling assembly consisting of a 12.25-inch tricone bit and tripped in hole to bottom of surface casing at 38 ft. Broke tower at 0800 hr, began drilling 12.25-inch hole using saturated brine as drilling fluid. Drilled from 38 ft to 250 ft adding salt gel to drilling fluid; circulated hole and tripped out drill pipe to collars. Secured site at 1750 hr.

5-11-95 Tripped in 12.25-inch bit to 250 ft; circulated hole using saturated brine water. Continued drilling from 250 ft. Worked on mud pump and shaker screen. Continued drilling 12.25-inch hole to 323 ft. Circulated hole and tripped out drill pipe, collars, and bit. Changed out bit. Secured site at 1740 hr.

5-12-95 Tripped in 12.25-inch bit to 323 ft; circulated hole using saturated brine water and salt gel. Continued drilling hole from 323 ft. Continued to have problems with shaker screen; repaired. Drilled 12.25-inch hole to 415 ft. Worked on mud pump. Circulated hole and tripped drill pipe to collars. Site secured at 1800 hr.

5-13-95 Finished repairing liners on mud pump. Tripped in drill pipe to 415 ft and circulated hole. Continued drilling 12.25-inch hole to 518 ft using saturated brine with salt gel. Still having mud pump problems. Circulated hole and tripped drill pipe to collars. Worked on repair of mud pump. Site secured at 1800 hr.

5-14-95 As tripping in drill pipe hit a "tight" spot at 140 ft; worked through it and thinned back mud. Reamed back to 518 ft and circulated hole. Continued drilling from 518 ft to 642 ft and circulated hole. Tripped back drill pipe to collars. Site secured at 1930 hr.

5-15-95 Tripped in hole with drill pipe reaming through "tight" spots. Circulated hole and continued drilling 12.25-inch hole using saturated brine water and salt gel. Drilled from 642 ft to 734 ft (casing depth). Circulated hole and tripped out drill pipe to collars. Site secured at 2130 hr.

5-16-95 Finished tripping out collars and bit. Inspected and tallied 27 joints of Centron DHC 300, 7-inch, 5.7 lb/ft fiberglass casing. Placed a combination guide shoe-float collar on bottom of first joint. Rigged up and ran 27 joints of casing setting the bottom of guide shoe at 732.35 ft. Centralizers were placed on the top of guide shoe-float collar and on top of casing joints numbers 1, 3, 6, 9, 12, 15, 18, 21, and 25. Western Cementing company on site at 1320 hr. Western rigged up circulation head and broke circulation. Commenced cementing operations at 1436 hr and pumped a slurry that included 70-30% pozzolan cement with 5% salt, 2% bentonite followed by a tail cement slurry consisting of Class C cement with 2% calcium chloride. Plug dropped and pumped down and cementing head was shut in at 1550 hr. About 126 sacks of cement were circulated to the surface and put in the pits. Rigged down Western and secured the site at 1800 hr. Wait on cement.

5-17-95 Wait on cement. Rig maintenance and preparations made to drill out cement.

5-18-95 Rigged up to drill out cement. Picked up 5.875-inch tricone bit and drill pipe and tripped in hole. Tagged top of cement fill at about 704 ft. Drilled out cement and rubber plug down to 735.5 ft using saturated brine water as drilling fluid. Circulated hole and tripped out drill pipe and bit. Picked up Christensen-Boyles wireline coring assembly (4.835-inch bit to cut 3.345-inch core) and tripped in hole on wireline pipe to 735.5 ft. Unloaded hole of brine water with compressed air. Rigged up to core using air as circulation fluid. Cut core #1 from 735.5 ft to 740.5 ft using air. Recovered 4.8 ft of core (96%). Cut core # 2 from 740.5 ft to 745.5 ft and recovered 5.0 ft of 3.45 inch core (100%). Top of the Culebra Dolomite was at 741.6 ft. Cut core #3 from 745.5 ft to 750.5 ft and recovered 5.0 ft of core (100%). Cut core #4 from 750.5 ft to 755.5 ft and recovered 4.5 ft of core (90%). Cut core #5 from 755.5 ft to 760.5 ft. Core barrel acted like it blocked off. Tripped out inner barrel and recovered 0.0 ft of core (0%). Cut core #6 from 760.5 ft to 764.5 ft and recovered 1.3 ft of core (33%). Evidently on last core run the core catcher was torn up and was left in hole. It was decided to try to recover the catcher before continuing to core. Site secured at 1830 hr.

5-19-95 Tripped in with inner barrel to try to recover core catcher. Cored from 764.5 ft to 766.7 ft and tripped out inner barrel; 0.5 ft recovery; however, it was difficult to determine depth that the core recovered came from. Inner barrel did not latch. Again tried to make a core run and inner barrel still not latching. Tripped out wireline pipe and coring assembly. Tripped in with 5.875-inch tricone bit and drill pipe in attempt to drill up catcher as the hole was reamed. Site secured at 1800 hr.

5-20-95 Finished tripping in drill pipe and 5.875-inch bit to ream core hole and try to drill up core catcher that was lost. Circulated hole with air and reamed core hole from 735.5 ft to 766.7 ft using air as drilling fluid. Continued drilling a "rat hole" from 766.7 ft down to 785.0 ft. Circulated hole clean and tripped out drill pipe and bit. Moved off hole. Hole completed at a total depth of 785.0 ft. Site was secured at 1800 hr.

NOTE: Because of problems in maintaining an open hole in the section below the Culebra in H-19b2 the hole was reoccupied on 8-27-95.

8-27-95 Rigged up Water Development rig Dresser T70W over H-19b2 to ream out borehole and run a PVC liner to seal off the unnamed lower member of the Rustler Formation. Rigged up and tripped in hole with 5.875-inch tricone bit and drill pipe to 735.5 ft. Unloaded borehole with compressed air and reamed borehole from 735.5 ft to 785.4 ft using air as circulation fluid. Circulated hole and tripped out with drill pipe and bit. Rigged up a 19.97-ft joint of PVC (5.5-inch OD and 4.88-inch ID) liner on a Baker inflatable packer and tripped in hole. Released liner in hole from 764.0 ft to 784.0 ft; may have slid to bottom. Deflated packer and left assembly in the hole overnight for complete deflation. Site secured at 1730 hr.

8-28-95 Tripped out drill pipe and packer. Drilling operations on H-19b2 completed. Rigged down and moved rig to H-19b3.

9-6-95 U.S. Geological Survey ran geophysical logs on H-19b2. Logs run included natural gamma, neutron porosity, and caliper.

Operations associated with drilling phase completed on H-19b2.

HYDROLOGIC DRILLHOLE H-19b3 ABRIDGED HOLE HISTORY

The following hole history was abstracted from Sandia National Laboratories' daily drilling records. Tailgate safety meetings were held each day prior to the beginning of operations.

NOTE: All depths are measured from ground level.

4-23-95 Cut off surface casing at H-19b3 location. Rigged up Water Development rig, Dresser T70W, over 14-inch surface casing and established depth control for well (v-notch cut in surface casing). Set up mud pumps and shale shaker. Site secured at 1800 hr.

4-24-95 Made up drilling assembly consisting of a 12.25-inch tricone bit and tripped in hole to bottom of surface casing at 38 ft. Broke tower at 0841 hr, began drilling 12.25-inch hole using saturated brine and salt gel as drilling fluid. Drilled from 38 ft to 236 ft; circulated hole clean and tripped out drill pipe to collars. Secured site at 1830 hr.

4-25-95 Tripped in 12.25-inch bit and reamed hole down to 236 ft; circulated hole using saturated brine water. Continued drilling 12.25-inch hole from 236 ft to 364 ft. Circulated hole and tripped out drill pipe to collars. Secured site at 1940 hr.

4-26-95 Finished tripping out collars and bit. Changed out bit putting on tricone button bit. Tripped in new 12.25-inch bit reaming hole back to 364 ft; circulated hole using saturated brine water and salt gel. Continued drilling hole from 364 ft to 518 ft. Circulated hole and tripped out drill pipe to collars. Site secured at 2010 hr.

4-27-95 Coupling went out on mud pump as rigged up to trip in hole. Repaired coupling and continued tripping in hole at 0900 hr reaming hole back to 518 ft. Continued drilling from 518 ft to 613 ft and circulated hole. Tripped back drill pipe to collars. Site secured at 1830 hr.

4-28-95 Tripped in hole with drill pipe reaming hole down to 613 ft. Continued drilling 12.25-inch-hole from 613 ft to 725 ft. Circulated hole and tripped out drill pipe to collars. Site secured at 1845 hr.

4-29-95 Tripped in hole with drill pipe and bit; reamed hole as tripped in. Mud hose blew and plugged bit. Tripped out drill pipe, collars, and bit. Cleaned up bit and tripped back in hole to 725 ft; circulated hole. Continued drilling 12.25-inch hole from 725 ft to 734 ft (casing depth); circulated hole. Tripped out drill pipe to collars. Site secured at 2145 hr.

4-30-95 Finished tripping out collars and bit. Inspected and tallied 27 joints of Centron DHC 300, 7-inch, 5.7 lb/ft, fiberglass casing. Placed a combination guide shoe-float collar on bottom of first joint. Rigged up and ran 27 joints of casing setting the bottom of guide shoe at 732.04 ft. Centralizers were placed on the top of guide shoe-float collar and on top of casing joints numbers 1, 3, 6, 9, 12, 15, 18, 21, and 25. Western Cementing company on site at 1415 hr. Western rigged up circulation head and broke circulation. Commenced cementing operations at 1515 hr and pumped a slurry that included 70-30% pozzolan cement with 5% salt, 2% bentonite followed by a tail cement slurry consisting of Class C cement with 2% calcium chloride. Plug dropped and pumped down and cementing head was shut in at 1554 hr. About 30 barrels of cement were circulated to the surface and put in the pits. Rigged down Western and cleaned up. Secured the site at 1800 hr. Wait on cement.

5-01-95 Wait on cement. Changing over equipment to drill out cement. Picked up 5.875-inch tricone bit and tripped in hole to 600 ft. Standby. Site secured at 1730 hr.

5-02-95 Finished tripping in bit and drill pipe and tagged top of cement fill at about 710 ft. Rigged up to drill out cement. Drilled out cement and rubber plug and continued hole down to 735.3 ft using saturated brine water as drilling fluid. Circulated hole. Changed out drilling fluid with Culebra brine. Tripped out drill pipe and bit. Picked up Christensen-Boyles wireline coring assembly (4.835-inch bit to cut 3.345-inch core) and tripped in hole on wireline pipe to 735.3 ft. Rigged up to core using Culebra brine as circulation fluid. Cut core #1 from 735.3 ft to 740.3 ft and recovered 4.7 ft of core (94%). Upper contact of the Culebra was at 740.0 ft. Cut core #2 from 740.3 ft to 745.3 ft and recovered 3.4 ft of core (68%). Cut core #3 from 745.3 ft to 750.3 ft and recovered 4.9 ft of core (98%). Cut core #4 from 750.3 ft to 755.3 ft and recovered 4.3 ft of core (86%). Problems with latching mechanism on inner barrel. Cut core #5 from 755.3 ft to 760.3 ft and recovered 0.0 ft of core (0%). Cut core # 6 from 760.3 ft to 764.3 ft and recovered 0.0 ft of core (0%). Cut core #7 from 764.3 ft to 766.3 ft when barrel blocked off. Tripped out inner barrel, no core. Cut core run #8 from 766.3 ft to 768.3 ft. Core barrel blocked off. Tripped out wireline pipe and coring assembly and found no core recovered; core barrel blocked off in bit. Secured site at 2200 hr.

5-03-95 Because of scheduling decided to move rig temporarily off hole so a pumping test of the Culebra could be conducted. Rigged down and moved off hole. Cleaned up site. Site secured at 1730 hr. Crew on break during testing.

5-04-95 No drilling activity. Crew on break.

5-05-95 No drilling activity. Crew on break.

5-06-95 No drilling activity. Crew on break.

5-07-95 No drilling activity. Crew on break.

5-08-95 No drilling activity. Crew on break.

5-09-95 Testing on H-19b3 completed. Moved back Dresser T70W rig and rigged up over existing hole. Decision was made to ream out core hole using a 5.875-inch tricone bit and continue the hole down making a "rat hole" below the Culebra. Tallied drill pipe and picked up 5.875-inch bit. Tripped in hole to 735.3 ft and reamed core hole to 768.3 ft using Culebra brine as drilling fluid. Continued drilling 5.875-inch "rat hole" from 768.3 ft to a total depth of 784.0 ft. Circulated hole and tripped out drill pipe and bit. Drilling of H-19b3 was completed so demobilized rig and moved to H-19b2. Site secured at 1730 hr.

NOTE: Because of hole problems in the unnamed lower member of the Rustler Formation, H-19b3 was reoccupied on 8-28-95.

8-28-95 Rigged up Water Development Dresser T70W rig over H-19b3 to ream out borehole below the Culebra and run in a PVC liner to keep hole from collapsing. Picked up 5.875-inch tricone bit and drill pipe and tripped in hole to 734.0 ft. Unloaded hole with compressed air and reamed hole from 734.0 ft to 784.9 ft. Circulated hole and tripped out drill pipe and bit. Rigged up a 19.97-ft joint of PVC (5.5-inch OD and 4.88-inch ID) on a Baker inflatable packer and tripped liner assembly in hole on drill pipe. Placed liner in hole covering an interval from

763.2 ft to 783.2 ft. Deflated the packer and left in the hole overnight for complete deflation. Site secured at 1700 hr.

8-29-95 Packer was checked and was free from liner. Moved packer up hole and reinflated above liner to be sure liner was left in hole. Tripped out packer and drill pipe. Rigged down and moved to H-19b3. Site secured at 1730 hr.

9-05-95 U.S. Geological Survey on site to complete final geophysical logging. Logs run on H-19b3 included natural gamma, neutron porosity, and caliper.

Operations associated with drilling completed on H-19b3.

HYDROLOGIC DRILLHOLE H-19b4 ABRIDGED HOLE HISTORY

The following hole history was abstracted from Sandia National Laboratories' daily drilling records. Tailgate safety meetings were held each day prior to the beginning of operations.

NOTE: All depths are measured from ground level.

5-20-95 Cut off surface casing at H-19b4 location. Rigged up Water Development rig, Dresser T70W, over 14-inch surface casing and established depth control for well (v-notch cut in surface casing). Set up mud pumps and shale shaker. Raised mast. Made up drilling assembly consisting of a 12.25-inch tricone button bit and tripped in hole to bottom of surface casing at 38 ft. Broke tower at 1345 hr, began drilling 12.25-inch hole using saturated brine and salt gel as drilling fluid. Drilled from 38 ft to 141 ft; circulated hole clean, and tripped out drill pipe to collars. Site secured at 1800 hr.

5-21-95 Circulated hole as drill pipe was tripped in. Continued drilling 12.25-inch hole from 141 ft to 376 ft. Circulated hole and tripped out drill pipe to collars. Site secured at 1800 hr.

5-22-95 Tripped in drill pipe and using 12.25-inch bit reamed through "tight" spots at 140 ft and at 180 ft. Top head leaking so replaced bearings. Circulated hole using saturated brine water and salt gel, back on bottom at 376 ft. Continued drilling 12.25-inch hole from 376 ft to 575 ft. Circulated hole and tripped out drill pipe to collars. Secured site at 1800 hr.

5-23-95 Tripped in drill pipe using 12.25-inch bit to ream hole through "tight" spots at 140 ft and 180 ft; back to bottom at 575 ft. Circulated hole using saturated brine water and salt gel. Continued drilling hole from 575 ft to 660 ft. Slow drilling anhydrite. Circulated hole and tripped out drill pipe to collars. Site secured at 1800 hr.

5-24-95 Tripped in drill pipe to 660 ft, did not encounter "tight" spots. Circulated hole using saturated brine and salt gel as drilling fluid. Continued drilling from 660 ft to 705 ft; drilling very slow. Will change out bit. Circulated hole and tripped back drill pipe to collars. Site secured at 1800 hr. Crew going on break.

5-25-95 No drilling activity. Crew on break.

5-26-95 No drilling activity. Crew on break.

5-27-95 No drilling activity. Crew on break.

5-28-95 No drilling activity. Crew on break.

5-29-95 No drilling activity. Crew on break.

5-30-95 No drilling activity. Crew on break.

5-31-95 Tripped in hole with drill pipe, collars, and new 12.25-inch bit; reamed hole as tripped in to 705 ft. Circulated hole and continued drilling from 705 ft to 734.0 ft (casing depth). Finished hole at 1300 hr. Circulated hole and tripped out drill pipe to collars. Site secured at 1800 hr.

6-01-95 Finished tripping out collars and bit. Inspected and tallied 27 joints of Centron DHC 300, 7-inch, 5.7 lb/ft, fiberglass casing. Placed a combination guide shoe-float collar on bottom of first joint. Rigged up and ran 27 joints of casing setting the bottom of guide shoe at 730.7 ft.

Centralizers were placed on the top of guide shoe-float collar and on top of casing joints numbers 1, 3, 6, 9, 12, 15, 18, 21, 24, and 25. Western Cementing company on site at 1330 hr. Western rigged up circulation head and broke circulation 1430 hr. Commenced cementing operations at 1431 hr and pumped a slurry that included 70-30% pozzolan cement with 5% salt, 2% bentonite followed by a tail cement slurry consisting of Class C cement with 2% calcium chloride. Plug dropped, pumped down, and bumped at 1504 hr and cementing head was shut in. Cements were circulated to the surface and put in the pits. Rigged down Western and cleaned up. Secured the site at 1700 hr. Standby, wait on cement.

6-02-95 Wait on cement. Changing over equipment to drill out cement. Picked up 5.875-inch tricone bit and tripped in hole to 620 ft. Standby. Site secured at 1730 hr.

6-03-95 Finished tripping in bit and drill pipe and tagged top of cement fill at about 720 ft. Rigged up to drill out cement. Drilled out cement and rubber plug and continued drilling hole down to 735.4 ft using saturated brine water as drilling fluid. Circulated hole. Tripped out drill pipe and bit. Picked up Christensen-Boyles wireline coring assembly (4.835-inch bit to cut 3.345-inch core) and tripped in hole on wireline pipe to 735.5 ft. Unloaded hole with compressed air. Rigged up to core using compressed air as circulation fluid. Cut core #1 from 735.5 ft to 740.5 ft and recovered 5.0 ft of core (100%). Cored through the upper contact of the Culebra Dolomite at 738.5 ft. Cut core #2 from 740.5 ft to 745.5 ft and recovered 5.0 ft of core (100%). Cut core #3 from 745.5 ft to 750.5 ft and recovered 5.0 ft of core (100%). Cut core #4 from 750.5 ft to 755.5 ft and recovered 5.0 ft of core (100%). Problems with latching mechanism on inner barrel. Cut core #5 from 755.5 ft to 760.5 ft and recovered 5.0 ft of core (100%). Cut core #6 from 760.5 ft to 761.5 ft where bit plugged. Tripped out inner barrel and recovered 0.2 ft of core (20%). Secured site at 1800 hr.

6-04-95 Rigged up inner barrel to continue coring operation. Unloaded hole with compressed air. Cut core #7 from 761.5 ft to 766.5 ft using compressed air as coring fluid. Tripped out inner barrel and recovered 4.5 ft of core (90%). Hit contact of the Culebra and the unnamed lower member of the Rustler Formation at 761.8 ft. Cut core #8 from 766.5 ft to 771.5 ft and recovered 5.0 ft of core (100%). Cut core #9 from 771.5 ft to 776.5 ft and recovered 5.0 ft of core (100%). Cut core #10 from 776.5 ft to 781.5 ft and recovered 5.0 ft of core (100%). Coring completed at a total depth of 781.5 ft. Developed well by letting it set and then blowing out the water with air. Circulated the hole. Tripped out wireline pipe and coring assembly. Rig on standby. Site secured at 1700 hr.

6-05-95 Standby. Picked up 5.875-inch tricone bit to ream core hole. Tripped in hole with bit and drill pipe to 735.5 ft; unloaded hole with compressed air. Reamed core hole with 5.875-inch bit from 735.5 ft to 781.5 ft. Circulated hole and tripped out drill pipe and bit. Site secured at 1730 hr.

6-06-95 Standby. Worked on mud pumps. Site secured at 1730 hr.

6-07-95 Standby. Worked on equipment. Site secured at 1700 hr.

6-08-95 Standby. Pulled pump. Site secured at 1700 hr.

6-09-95 Standby. Installed injection tool in H-19b4. Site secured at 1700 hr.

6-10-95 Standby. Set packer for INTERA. Rigged down from H-19b4 and moved off hole. Site secured at 1730 hr. Hole completed.

NOTE: Because of a lost pump and hole problems in the unnamed lower member of the Rustler Formation, H-19b4 was reoccupied on 8-20-95.

8-20-95 During testing operations, a submersible pump was dropped in H-19b4. Moved over hole with Dresser T70W to “fish” pump from hole. Rigged up overshot and tripped in hole to try to recover pump. Tagged top of pump but did not recover. Tripped in and out with different sized overshot, but not able to recover “fish.” Site secured at 1800 hr.

8-21-95 Rigged up new overshot and tripped in hole on drill pipe. After several unsuccessful attempts at trying to recover pump, it was decided to drill up fish. Picked up 5.875-inch tricone bit and tripped in hole. Reamed lower portion of hole down to 781.3 ft using compressed air as circulation fluid. Tripped out bit and drill pipe. Because of hole problems in the unnamed lower member of the Rustler Formation, it was decided to run in a PVC liner to keep hole from collapsing. Rigged up a 19.20-ft joint of PVC (5.5-inch OD and 4.88-inch ID) on a Baker inflatable packer and tripped liner assembly in hole on drill pipe. Placed liner in hole covering an interval from 761.0 ft to 780.2 ft. Deflated the packer and left in the hole overnight for complete deflation. Site secured at 1800 hr.

8-22-95 Packer was checked and was free from liner. Liner may have slid 0.8 ft. Moved packer up hole and reinflated above liner to be sure liner was left in hole. Tripped out packer and drill pipe. Rigged down and moved to H-19b6. Site secured at 1800 hr.

9-06-95 U.S. Geological Survey on site to complete final geophysical logging. Logs run on H-19b4 included natural gamma, neutron porosity, and caliper.

Operations associated with drilling completed on H-19b4.

HYDROLOGIC DRILLHOLE H-19b5 ABRIDGED HOLE HISTORY

The following hole history was abstracted from Sandia National Laboratories' daily drilling records. Tailgate safety meetings were held each day prior to the beginning of operations.

NOTE: All depths are measured from ground level.

6-11-95 Cut off surface casing at H-19b5 location. Rigged up Water Development rig, Dresser T70W, over 14-inch surface casing and established depth control for well (v-notch cut in surface casing). Set up mud pumps and shale shaker. Raised mast. Talled drilling assembly, collars, and drill pipe. Made up drilling assembly consisting of a 12.25-inch tricone button bit and tripped in hole to bottom of surface casing at 38.4 ft. Broke tower at 1405 hr, began drilling 12.25-inch hole using saturated brine and salt gel as drilling fluid. Drilled from 38.4 ft to 92.7 ft; circulated hole clean and tripped out drill pipe to collars. Site secured at 1800 hr.

6-12-95 Circulated hole using saturated brine with salt gel as drilling fluid. Continued drilling 12.25-inch hole from 92.7 ft to 240 ft. Circulated hole and tripped out drill pipe to collars. Site secured at 1730 hr.

6-13-95 Changed drilling assembly by adding additional double pin sub and reamer. Tripped in new drilling assembly, collars, and drill pipe. Continued drilling hole using 12.25-inch bit and saturated brine and salt gel as drilling fluid. Drilled from 240 ft to 278 ft. Problems with top head leaking. Circulated hole. Repaired top head. Circulated hole and tripped out drill pipe to collars. Secured site at 1700 hr. Crew going on break. Days off.

6-14-95 No drilling activity. Crew on break.

6-15-95 No drilling activity. Crew on break.

6-16-95 No drilling activity. Crew on break.

6-17-95 No drilling activity. Crew on break.

6-18-95 No drilling activity. Crew on break.

6-19-95 No drilling activity. Crew on break.

6-20-95 Rigged up to continue drilling, found swivel leaking. Repacked swivel. Tripped in drill pipe using 12.25-inch bit to ream hole through "tight" spots. Back to bottom at 278 ft. Circulated hole using saturated brine water and salt gel. Continued drilling 12.25-inch hole from 278 ft to 336 ft. Circulated hole and tripped out drill pipe to collars. Site secured at 1800 hr.

6-21-95 Tripped in drill pipe to 336 ft, did not encounter "tight" spots. Circulated hole using saturated brine and salt gel as drilling fluid. Top head still leaking. Decided to change out top head, but will wait until new one is sent from Woodland. Continued drilling from 336 ft to 403 ft. Circulated hole and tripped back drill pipe to collars. Site secured at 1745 hr.

6-22-95 Reamed hole as tripped in to 403 ft. Circulated hole and continued drilling from 403 ft. Added additional mud pump to increase drilling fluid volume. Rod packing on mud pump blew out; stopped drilling and repaired. Continued drilling 12.25-inch hole to 504 ft. Circulated hole and tripped out drill pipe to collars. Site secured at 1745 hr.

6-23-95 Tripped in drill pipe using 12.25-inch bit to ream hole through “tight” spots. Back to bottom at 504 ft. Circulated hole using saturated brine water and salt gel. Continued drilling 12.25-inch hole from 504 ft to 550 ft. Top head continued to cause problems and is now getting hot, decided to shut down and replace head. Circulated hole and tripped out drill pipe to collars. Began to disassemble head. Site secured at 1800 hr.

6-24-95 Down for repairs. Replacing top head. Site secured at 1830 hr.

6-25-95 Rigged up head. Tripped in drill pipe, reamed “tight” spots, and back on bottom at 550 ft. Circulated hole and continued drilling 12.25-inch hole from 550 ft to 594 ft. Circulated hole and tripped out drill pipe to collars. Site secured at 1850 hr.

6-26-95 Rig maintenance. Tripped in drill pipe, reamed “tight” spots, and back on bottom at 594 ft. Circulated hole using saturated brine water and salt gel as drilling fluid. Continued drilling 12.25-inch hole from 594 ft to 675 ft. Circulated hole and tripped out drill pipe to collars. Site secured at 1800 hr.

6-27-95 Tripped in drill pipe to 675 ft; did not encounter any “tight” spots. Circulated hole using saturated brine and salt gel as drilling fluid. Continued drilling 12.25-inch hole from 675 ft to 695 ft. Very hard drilling. Shut down drilling because of bad weather. Circulated hole and tripped out drill pipe to collars. Site secured at 1800 hr.

6-28-95 Tripped in drill pipe to 695 ft; did not encounter any “tight” spots. Circulated hole. Continued drilling 12.25-inch hole from 695 ft to 705 ft. Very hard drilling. Bit problems so decided to trip out bit and change out with a new one. Circulated hole and tripped out drill pipe, collars, and bit. Found bit cone oil seal out and one cone about to come off. Replaced bit with new one. Tripped in bit, collars and started tripping in drill pipe. Site secured at 1730 hr.

6-29-95 Finished tripping in drill pipe. Bit on bottom at 705 ft; circulated hole and continued drilling from 705 ft to 734.2 ft (casing depth). Circulated hole and tripped out drill pipe, collars, and bit assembly. Out of hole at 1500 hr. Inspected and tallied 27 joints of Centron DHC 300, 7-inch, 5.7 lb/ft, fiberglass casing. Placed a combination guide shoe-float collar on bottom of first joint. Rigged up and started running casing. Shut down because of lightning storm. Finish running 27 joints of casing, landing the bottom of guide shoe at 730.7 ft at 1810 hr. Centralizers were placed on the top of guide shoe-float collar and on top of casing joints numbers 1, 3, 6, 9, 12, 15, 18, 21, and 25. Western Cementing company on site at 1430 hr. Western rigged up circulation head and broke circulation 1838 hr. Commenced cementing operations at 1843 hr and pumped a slurry that included 70-30% pozzolan cement with 5% salt, 2% bentonite followed by a tail cement slurry consisting of Class C cement with 2% calcium chloride. Plug dropped, pumped down, and bumped at 1917 hr, and cementing head was shut in. Cement was circulated to the surface, and about 54 sacks were put in the pits. Rigged down Western and cleaned up. Secured the site at 2030 hr. Standby, wait on cement. Crew went on break. Days off.

6-30-95 No drilling activity. Crew on break.

7-01-95 No drilling activity. Crew on break.

7-02-95 No drilling activity. Crew on break.

7-03-95 No drilling activity. Crew on break.

7-04-95 No drilling activity. Crew on break.

7-05-95 No drilling activity. Crew on break.

7-06-95 Changing over equipment to drill out cement. Break off cementing head. Picked up 5.875-inch tricone bit and drill pipe and tripped in hole. Tagged top of cement fill at 722 ft. Rigged up to drill out cement. Drilled out cement and rubber plug and continued drilling hole down to 736 ft using saturated brine water as drilling fluid. Circulated hole. Tripped out drill pipe and bit. Standby. Waited for location of H-19b6; may move to drill H-19b6 before H-19b5 is completed. Site secured at 1730 hr.

7-07-95 Standby. Worked on rig. Site secured at 1730 hr.

7-08-95 Standby. Worked on rig. Moved trailers. Site secured at 1830 hr.

7-09-95 Standby. Worked on rig and set surface casing for H-19b6. Rigged down from H-19b5 and moved equipment to H-19b6. Site secured at 1730 hr.

NOTE: Rig was moved to H-19b6, and that drillhole was completed. Rig was moved back to H-19b5 to complete hole on August 25, 1995.

8-25-95 Moved Dresser T70W rig over H-19b5. Set mud pumps and shaker. Rigged up Christensen-Boyles wireline coring assembly (4.835-inch bit to cut 3.345-inch core), picked up, and tripped in hole on wireline pipe to 735.5 ft. Unloaded hole with compressed air. Rigged up to core using compressed air as circulation fluid. Cut core #1 from 735.5 ft to 740.5 ft and recovered 4.6 ft of core (92%). Hit upper contact of Culebra at 736.7 ft. Cut core #2 from 740.5 ft to 745.5 ft and recovered 5.0 ft of core (100%). Cut core #3 from 745.5 ft to 750.5 ft and recovered 4.2 ft of core (84%). Cut core #4 from 750.5 ft to 755.5 ft and recovered 3.0 ft of core (60%). Problems with latching mechanism on inner barrel. Cut core #5 from 755.5 ft to 760.5 ft and recovered 4.5 ft of core (90%). Cut core #6 from 760.5 ft to 765.5 ft and recovered 4.1 ft of core (82%). Hit the contact of Culebra and the unnamed lower member of the Rustler Formation at 761.2 ft. Cut core #7 from 765.5 ft to 770.5 ft. Tripped out inner barrel and recovered 5.0 ft of core (100%). Cut core #8 from 770.5 ft to 775.5 ft and recovered 4.8 ft of core (96%). Cut core #9 from 775.5 ft to 780.5 ft and recovered 5.0 ft of core (100%). Cut core #10 from 780.5 ft to 785.5 ft and recovered 3.5 ft of core (70%). Coring completed at a total depth of 785.5 ft. Circulated the hole. Started tripping out wireline pipe and breaking at each joint because coring operations have been completed. Site secured at 1830 hr.

8-26-95 Finished tripping out and breaking down wireline pipe. Moved out wireline pipe and moved in drill pipe. Picked up 5.875-inch tricone bit to ream core hole. Tripped in hole with bit and drill pipe to 735.5 ft; unloaded hole with compressed air. Using compressed air as drilling fluid, reamed core hole with 5.875-inch bit from 735.5 ft to 785.5 ft. Circulated hole and tripped out drill pipe and bit. To keep the hole from collapsing below the Culebra, it was decided to place a PVC liner in the unnamed lower member of the Rustler Formation. Rigged up a 19.97-ft joint of PVC (5.5-inch OD and 4.88-inch ID) on a Baker inflatable packer and tripped liner assembly in hole on drill pipe. Placed liner in hole covering an interval from 761.0 ft to 781.0 ft. Deflated the packer and left in the hole overnight for complete deflation. Site secured at 1800 hr.

8-27-95 Packer was checked and was free from liner. Liner may have slid 0.7 ft. Moved packer up hole and reinflated above liner to be sure liner was left in hole. Tripped out packer and drill pipe. Rigged down and moved to H-19b2.

9-06-95 U.S. Geological Survey on site to complete final geophysical logging. Logs run on H-19b5 included natural gamma, neutron porosity, and caliper. Moved to H-19b7 to complete logging of drillhole.

Operations associated with drilling completed on H-19b5.

HYDROLOGIC DRILLHOLE H-19b6 ABRIDGED HOLE HISTORY

The following hole history was abstracted from Sandia National Laboratories' daily drilling records. Tailgate safety meetings were held each day prior to the beginning of operations.

NOTE: All depths are measured from ground level.

7-10-95 Cut off surface casing at H-19b6 location. Rigged up Water Development rig, Dresser T70W, over 14-inch surface casing and established depth control for well (v-notch cut in surface casing). Set up mud pumps and shale shaker. Raised mast. Tallied drilling assembly, collars, and drill pipe. Made up drilling assembly consisting of a 12.25-inch tricone button bit and tripped in hole to bottom of surface casing at 39 ft. Broke tower at 1315 hr, began drilling 12.25-inch hole using saturated brine and salt gel as drilling fluid. Drilled from 39 ft to 159.6 ft; circulated hole and tripped out drill pipe to collars. Site secured at 1815 hr.

7-11-95 Moved drill pipe to site. Rigged up and circulated hole using saturated brine with salt gel as drilling fluid. Continued drilling 12.25-inch hole from 159.6 ft to 322 ft when mud line from pump broke. Fixed mud pump line. Circulated hole and tripped out drill pipe to a "tight" spot at about 200 ft when lifting bail broke. Tools fell to bottom of hole. Called fishing company. Star Tool on site at 1845 hr. Rigged up overshot with 6.375-inch grapple and tripped in hole. Tagged top of "fish" at about 125 ft and was able to hook on to tools with grapple. Tripped out drill pipe to collars. Screw into collars and work through tight spot. Released fishing company and will trip out the rest of collars tomorrow. Site secured at 2215 hr.

7-12-95 Rigged up elevators and finished tripping out collars; worked through "tight" spots. Checked bit and decided to change it out as bit may have been damaged from the fall. Tripped in hole with new bit, collars, and drill pipe. Back on bottom at 322 ft. Circulated hole and continued drilling 12.25-inch hole from 322 ft to 376.2 ft. Circulated hole and tripped out of hole to collars. Site secured at 1800 hr.

7-13-95 Tripped in hole with drill pipe to bottom at 376.2 ft; no fill or "tight" spots. Circulated hole and continued drilling from 376.2 ft to 533.3 ft. Circulated the hole and tripped out drill pipe to collars. Site secured at 1815 hr.

7-14-95 Rig maintenance. Mixed up new saturated brine and salt gel and changed out mud. Tripped in drill pipe, reamed "tight" spots, and back on bottom at 533.3 ft. Circulated hole using new saturated brine water and salt gel. Continued drilling 12.25-inch hole from 533.3 ft to 616 ft. Circulated hole and tripped out drill pipe to collars. Site secured at 1800 hr.

7-15-95 Tripped in drill pipe to 616 ft; reamed through "tight" spots. Circulated hole using saturated brine and salt gel as drilling fluid. Continued drilling 12.25-inch hole from 616 ft to 685 ft. Very hard drilling. Circulated hole and tripped out drill pipe to collars. Site secured at 1810 hr.

7-16-95 Tripped in drill pipe to 685 ft; reamed through "tight" spots. Circulated hole. Continued drilling 12.25-inch hole from 685 ft to 711 ft. Very hard drilling. Bit problems, tripped out bit and changed out with a new one. Circulated hole and tripped out drill pipe to collars. Thunderstorm building so shut down for weather. Site secured at 1730 hr.

7-17-95 Finished tripping out collars and bit. Found bit cone oil seals out and cones about to come off. Bit had drilled only about 300 ft of hole (bad bit?). Replace bit with new tricone button bit. Tripped in bit, collars and started tripping in drill pipe. Problems with fuel system on shaker motor; repaired. Finished tripping in drill pipe. Bit on bottom at 711 ft; circulated hole and started to drill; however, lightning storm moved in so shut down for weather. Back to drilling at 1350 hr. Continued drilling from 711 ft to 732.8 ft (casing depth). Circulated hole and tripped out drill pipe to collars. Site secured at 1800 hr. Notified State Engineer's office and cement company that casing job would be tomorrow.

7-18-95 Finished tripping out collars and bit assembly. Rigged up to case hole. Inspected and tallied 27 joints of Centron DHC 300, 7-inch, 5.7 lb/ft, fiberglass casing. Placed a combination guide shoe-float collar on bottom of first joint. Rigged up and started running casing. Finished running 27 joints of casing, landing the bottom of guide shoe at 730.1 ft at 1140 hr. BJ-Western Cementing company on site at 1130 hr. Centralizers were placed on the top of guide shoe-float collar and on top of casing joints numbers 1, 3, 6, 9, 12, 15, 18, 21, and 25. BJ-Western rigged up circulation head and broke circulation 1313 hr. Commenced cementing operations at 1315 hr and pumped a slurry that included 70-30% pozzolan cement with 5% salt, 2% bentonite followed by a tail cement slurry consisting of Class C cement with 2% calcium chloride. Plug dropped, pumped down, and bumped at 1315 hr and cementing head was shut in. Cement was not circulated to the surface. Discussed with state representative and decided will have to run temperature survey to locate top of cement in the hole. Rigged down BJ-Western and cleaned up. Called Pro-Wireline to run temperature survey. Standby. Ran temperature survey and determined top of cement was at about 48 ft below ground level. State concurred that we could tremie cement on back side of casing. Found cement fill in casing at about 643 ft. Will have to drill out. Secured the site at 2100 hr.

7-19-95 Standby. Determined that cement fill inside casing was at about 643 ft. Because it is fiberglass casing, it was decided that the cement should be drilled out to shoe before crew breaks for days off. Moved over drill pipe. Picked up 5.875-inch bit and tripped in the hole to fill at 643 ft. Soft fill at 643 ft and top of set cement at about 655 ft. Circulated hole and began drilling out cement at 1246 hr. Continued drilling cement from 655 ft to 727.4 ft using saturated brine as drilling fluid. Circulated hole and tripped out drill pipe and bit. Will finish drill out after break. Site secured at 1800 hr. Crew on days off.

7-20-95 No drilling activity. Crew on break.

7-21-95 No drilling activity. Crew on break.

7-22-95 No drilling activity. Crew on break.

7-23-95 No drilling activity. Crew on break.

7-24-95 No drilling activity. Crew on break.

7-25-95 No drilling activity. It was decided that after drilling cement out of H-19b6 and prior to coring the Culebra, the rig would be moved to H-19b7.

7-26-95 Discussed plans for moving to H-19b7 prior to coring H-19b6. Rigged up drill pipe and 5.875-inch bit to drill out cement and shoe. Tripped in hole to 727.4 ft, circulated hole with saturated brine water as drilling fluid. Drilled out cement and shoe to 736.4 ft. Circulated hole

and tripped out drill pipe and bit. Rigged up one-inch pipe to tremie cement around casing (in annulus) since circulation of cement did not reach the surface. Analyses of cementing job would indicate that cement company may have prematurely dropped plug during cementing operations. Tagged cement in annulus at about 45 ft. Mixed cement slurry (Class C) and pumped down hole, circulating about 5 sacks to the pits. Cleaned up and tripped out tremie pipe. Rigged down Dresser T70W in preparation to move to H-19b7. Move off hole. Will return and finish H-19b6 after completion of H-19b7. Site secured at 1530 hr.

NOTE: Rig moved back from H-19b7 on August 22, 1995, to complete H-19b6.

8-22-95 Moved Dresser T70W over existing casing in preparation for coring the Culebra Dolomite. Inspected core barrel and bit. Found bit had cracks so replaced. Set mud pumps and shaker. Picked up Christensen-Boyles wireline coring assembly (4.835-inch bit to cut 3.345-inch core) and tripped in hole on wireline pipe to bottom of hole at 736.5 ft. Rigged up inner barrel assembly. Site secured at 1730 hr.

8-23-95 Changed over to core using compressed air as circulation fluid. Unloaded hole with compressed air. Cut core #1 from 736.5 ft to 741.5 ft and recovered 4.0 ft of core (80%). Hit upper contact of the Culebra at 739.0 ft. Cut core #2 from 741.5 ft to 746.5 ft and recovered 4.1 ft of core (82%). Cut core #3 from 746.5 ft to 751.5 ft and recovered 4.1 ft of core (82%). Cut core #4 from 751.5 ft to 755.2 ft and recovered 2.2 ft of core (60%). Core barrel blocked off. Cut core #5 from 755.2 ft to 759.2 ft and recovered 2.0 ft of core (50%). Cut core #6 from 759.2 ft to 764.2 ft and recovered 2.3 ft of core (46%). Cut core #7 from 764.2 ft to 768.1 ft. Trouble with core barrel blocking off. Tripped out inner barrel and recovered 3.1 ft of core (79%). Hit the contact between the Culebra and the unnamed lower member of the Rustler Formation at 763.8 ft. Cut core #8 from 768.1 ft to 773.1 ft and recovered 5.0 ft of core (100%). Cut core #9 from 773.1 ft to 778.1 ft and recovered 5.0 ft of core (100%). Cut core #10 from 778.1 ft to 783.1 ft and recovered 5.0 ft of core (100%). Cut core #11 from 783.1 ft to 788.1 ft and recovered 3.9 ft of core (78%). Coring completed at a total depth of 788.1 ft. Circulated the hole. Tripped out wireline pipe and coring assembly. Moved out wireline pipe. Moved in drill pipe. Picked up 5.875-inch tricone bit to ream core hole. Tripped in hole with bit and drill pipe to 730.1 ft. Rigged up air head getting ready to ream core hole. Site secured at 1820 hr.

8-27-95 Unloaded hole with compressed air. Using compressed air as drilling fluid; reamed core hole with 5.875-inch bit from 736.5 ft to 785 ft. Circulated hole and tripped out drill pipe and bit. To keep the hole from collapsing below the Culebra, it was decided to place a PVC liner in the unnamed lower member of the Rustler Formation. Rigged up a 19.97-ft joint of PVC (5.5-inch OD and 4.88-inch ID) on a Baker inflatable packer and tripped liner assembly in hole on drill pipe. Placed liner in hole covering an interval from 765.0 ft to 785.0 ft. Deflated the packer. Packer was checked and was free from liner. Moved packer up hole and reinflated above liner to be sure liner was left in hole. Checked out, PVC liner in proper location. Tripped out packer and drill pipe. Rigged down packer and drill rig. Site secured at 1800 hr.

9-05-95 U.S. Geological Survey on site to complete final geophysical logging. Logs run on H-19b6 included natural gamma, neutron porosity, and caliper.

Operations associated with drilling completed on H-19b6.

HYDROLOGIC DRILLHOLE H-19b7 ABRIDGED HOLE HISTORY

The following hole history was abstracted from Sandia's daily drilling records. Tailgate safety meetings were held each day prior to the beginning of operations.

NOTE: All depths are measured from ground level.

7-26-95 Cut off surface casing at H-19b7 location. Moved equipment from H-19b6. Rigged up Water Development rig, Dresser T70W, over 14-inch surface casing and established depth control for well (v-notch cut in surface casing). Set up mud pumps and shale shaker. Raised mast. Tallied drilling assembly, collars, and drill pipe. Made up drilling assembly consisting of a 6.25-inch tricone button bit. A smaller bit was used to accommodate wireline coring to be done (to start at about 685 ft). Site secured at 1830 hr.

7-27-95 Moved drill pipe to site and finished rigging up over H-19b7. Filled mud tanks with saturated (10-lb) brine and salt gel. Picked up 6.25-inch bit assembly and tripped in hole to bottom of surface casing at 38 ft. Broke tower at 1045 hr, began drilling 6.25-inch hole using saturated brine and salt gel as drilling fluid. Drilled from 38 ft to 217 ft; circulated hole clean and tripped out drill pipe to collars. "Tight" spot in hole at 150 ft; worked drill bit back and forth through zone. Site secured at 1815 hr.

7-28-95 Tripped in hole with drill pipe. Back on bottom at 217 ft; circulated hole and continued drilling 6.25-inch hole from 217 ft to 357 ft. Circulated hole and tripped out of hole to collars. Site secured at 1755 hr.

7-29-95 Tripped in hole with drill pipe to bottom at 357 ft; hit several "tight" spots. Reamed through "tight" spots and circulated hole. Continued drilling from 357 ft to 524.4 ft. Circulated the hole and tripped out drill pipe to collars. Site secured at 1800 hr.

7-30-95 Rig maintenance. Tripped in drill pipe, reamed "tight" spot at about 150 ft. Back on bottom at 524.4 ft. Circulated hole using saturated brine water and salt gel. Continued drilling 6.25-inch hole from 524.4 ft to 577.4 ft. Because of bit problems it was decided to trip in with wireline pipe and "drill" anhydrite with wireline bit "4.833 inches" so there would be an acceptable "pilot" hole to stabilize coring at 685 ft. Picked up Christensen-Boyles wireline coring assembly (4.833-inch bit) and tripped in on wireline pipe to bottom of hole at 577.4 ft. Rigged up and continued drilling a 4.833-inch-diameter hole from 577.4 ft to 592.4 ft. Circulated the hole. Site secured at 1745 hr.

7-31-95 Circulated hole using saturated brine and salt gel as drilling fluid; thinned down mud. Continued drilling 4.833-inch hole from 592.4 ft to 647.4 ft. Very hard drilling. Circulated hole and pulled back wireline pipe. Site secured at 1800 hr.

8-01-95 Tripped in wireline pipe to 647.4 ft; reamed through "tight" spots. Circulated hole using saturated brine water and salt gel. Continued drilling 4.833-inch hole from 647.4 ft to 678.6 ft (core point). Very hard drilling. Rigged up split inner barrel and run in on wireline to begin coring operation. Started cutting 3.345-inch core at 678.6 ft using Christensen-Boyles wireline coring system. Cut core #1 from 678.6 ft to 683.6 ft and recovered 5.0 ft of core (100%). Cut core #2 from 683.6 ft to 688.6 ft and recovered 5.0 ft of core (100%). Cut core #3 from 688.6 ft to 693.6 ft and recovered 5.0 ft of core (100%). Cut core #4 from 693.6 ft to

698.6 ft and recovered 5.0 ft of core (100%). Cut core #5 from 698.6 ft to 703.6 ft and recovered 5.0 ft of core (100%). Cut core #6 from 703.6 ft to 708.6 ft and recovered 5.0 ft of core (100%). Cut core #7 from 708.6 ft to 712.1 ft; barrel blocked off. Tripped out inner barrel and recovered 3.5 ft of core (100%). Cut core #8 from 712.1 ft to 715.3 ft; barrel blocked off. Recovered 3.2 ft of core (100%). Circulated the hole. Pull back wireline pipe. Site secured at 1845 hr.

8-02-95 Rigged up to core. Established circulation using saturated brine water and salt gel; however, wireline pipe or coring assembly “stuck.” Pulled on wireline pipe and tried to work pipe free; unable to move pipe. Decided to unload hole of drilling fluid with compressed air; pipe came free. Cleaned up around rig. Rigged up to core, established circulation with saturated brine and salt gel. Continued to core using wireline system. Cut core #9 from 715.3 ft to 720.3 ft and recovered 5.0 ft of core (100%). Cut core #10 from 720.3 ft to 725.3 ft and recovered 5.0 ft of core (100%). Cut core #11 from 725.3 ft to 730.3 ft and recovered 5.0 ft of core (100%). Cut core #12 from 730.3 ft to 735.3 ft (casing depth) and recovered 4.8 ft of core (96%). Finished coring the lower Tamarisk Member of the Rustler Formation. Tripped out wireline pipe and coring assembly in preparation for reaming borehole to 12.25 inches. Cleaned up coring equipment and secured site at 1800 hr.

8-03-95 Made up drilling assembly consisting of a 12.25-inch tricone button bit and stabilizers. Tripped in hole to bottom of surface casing at 38 ft. Began reaming 6.25-inch hole to 12.25 inches, using saturated brine and salt gel as drilling fluid. Picked up collars. Reamed from 38 ft to 297.4 ft; circulated hole and tripped out drill pipe to collars. Some “tight” spots. Site secured at 1800 hr.

8-04-95 Circulated hole using saturated brine with salt gel as drilling fluid. Continued reaming 6.25-inch hole to 12.25 inches from 297.4 ft to 564.7 ft. Circulated hole and tripped out drill pipe to collars. Site secured at 1830 hr.

8-05-95 Tripped in drill pipe. Circulated hole using saturated brine with salt gel as drilling fluid. Continued reaming 6.25-inch hole to 12.25 inches. Reamed from 564.7 ft to 678.6 ft. Problems with hard drilling in anhydrite. Hole size had been reduced to 4.833 inches at 678.6 ft. Continued reaming hole to 12.25 inches from 678.6 ft to 682 ft. Circulated hole and tripped out drill pipe to collars. Notified State Engineer’s office and cementing company of pending casing job. Secured site at 1800 hr.

8-06-95 Rigged up to trip in drill pipe, but had problems with gate latching on top head drive. Repaired and tripped in drill pipe to bottom at 682 ft. Circulated hole using saturated brine with salt gel as drilling fluid. Continued reaming 4.833-inch core hole to 12.25 inches from 682 ft to 733.6 ft (casing depth). Circulated and conditioned hole to run casing. Tripped out drill pipe, collars, and bit and stabilizer assembly. Staged fiberglass casing and made up combination casing shoe-float collar. Site secured at 1730 hr.

8-07-95 Inspected and tallied 27 joints of Centron DHC 300, 7-inch, 5.7 lb/ft, fiberglass casing. Placed a combination guide shoe-float collar on bottom of first joint. Rigged up and started running casing. Finished running 27 joints of casing, landing the bottom of guide shoe at 731.01 ft at 0930 hr. BJ-Western Cementing company on site at 0935 hr. Centralizers were placed on the top of guide shoe-float collar and on top of casing joints numbers 1, 3, 6, 9, 12, 15, 18, 21, 24, and 25. BJ-Western rigged up circulation head and broke circulation at 1050 hr. Commenced cementing operations at 1055 hr and pumped a slurry that included 70–30%

pozzolan cement with 5% salt, 2% bentonite followed by a tail cement slurry consisting of Class C cement with 2% calcium chloride. Plug was dropped, pumped down, and bumped at 1134 hr, and cementing head was shut in. State inspectors on site during cementing operations. Cement was circulated to the surface putting about 118 sacks of cement in pits. Demobilized BJ-Western and cleaned up. Wait on cement. Standby. Secured the site at 1800 hr.

8-08-95 Standby. Wait on cement. Crew steamed off collars. At 1330 hr picked up 5.875-inch bit and drill pipe and tripped in the hole to cement fill at 709 ft. Circulated hole and began drilling out cement. Continued drilling cement from 709 ft to 735.9 ft using saturated brine as drilling fluid. Circulated hole and tripped out drill pipe and bit. Site secured at 1815 hr.

8-09-95 Inspected core barrel and bit. Moved in wireline pipe and picked up Christensen-Boyles wireline coring assembly (4.835-inch bit to cut 3.345-inch core) and tripped in hole on wireline pipe to bottom of hole at 736.0 ft. Rigged up inner barrel assembly. Changed over to coring using compressed air as circulation fluid. Unloaded hole with compressed air. Core run numbers will continue where coring left off August 2, 1995. Cut core #13 from 736.0 ft to 741.0 ft and recovered 4.6 ft of core (92%). Hit upper contact of the Culebra at 739.5 ft. Cut core #14 from 741.0 ft to 746.0 ft and recovered 4.9 ft of core (98%). While running in hole with inner barrel on wireline, the inner barrel unlatched and fell to bottom, ruining core catcher and bit assembly. Tripped out wireline pipe and coring assembly. Broke down core barrel, seemed all right, will wait for replacement parts. Site secured at 1807 hr. Crew on break (days off).

8-10-95 No drilling activity. Crew on break.

8-11-95 No drilling activity. Crew on break.

8-12-95 No drilling activity. Crew on break.

8-13-95 No drilling activity. Crew on break.

8-14-95 No drilling activity. Crew on break.

8-15-95 No drilling activity. Crew on break.

8-16-95 Reworked core barrel; made decision to drill one ft of new hole with bit to try to drill up core catcher "fish." Changed plans. Called Lea fishing to try to recover "fish" with a magnet. Made numerous trips in hole with magnet, but not able to recover "fish." Site secured at 1830 hr.

8-17-95 Decided to trip in core barrel and try to core over "catcher." Tallied wireline pipe, picked up coring assembly, and tripped in hole to 746.0 ft. Changed over to core using compressed air as circulation fluid. Unloaded hole with compressed air. Core runs numbers will continue where coring left off August 9, 1995. Cut core #15 from 746.0 ft to 750.2 ft and recovered 2.6 ft of core (62%). Cut core #16 from 750.2 ft to 754.7 ft and recovered 3.0 ft of core (67%). Recovered several small pieces of metal from catcher. While retrieving inner barrel, swivel came loose so will trip wireline pipe and core barrel. Tripped out and made repairs. Tripped back in hole to 754.7 ft. Continued coring from 754.7 ft using compressed air as coring fluid. Cut core #17 from 754.7 ft to 759.7 ft and recovered 4.3 ft of core (86%). Cut core #18 from 759.7 ft to 764.7 ft and recovered 2.7 ft of core (54%). Hit lower contact of the Culebra with the unnamed lower member at 764 ft. Cut core #19 from 764.7 ft to 768.0 ft where core barrel blocked off. Recovered 1.7 ft of core (52%). Cut core #20 from 768.0 ft to 773.0 ft and recovered 4.0 ft of core (80%). Cut core #21 from 773.0 ft to 778.0 ft and recovered 5.0 ft of

core (100%). Cut core #22 from 778.0 ft to 783.0 ft. Recovered 5.0 ft of core (100%). Completed coring at a total depth of 783.0 ft. Circulated the hole. Site secured at 1730 hr.

8-18-95 Tripped out wireline pipe and coring assembly. Moved out wireline pipe. Moved in drill pipe. Picked up 5.875-inch tricone bit to ream core hole. Tripped in hole with bit and drill pipe to 735.9 ft. Rigged up air head getting ready to ream core hole. Unloaded hole with compressed air. Using compressed air as drilling fluid; reamed core hole with 5.875-inch bit from 735.9 ft to 783.0 ft and drilled new hole to 785.0 ft (TD). Circulated hole and tripped out drill pipe and bit.

8-19-95 To keep the hole from collapsing below the Culebra, it was decided to place a PVC liner in the unnamed lower member of the Rustler Formation. Picked up 5.875-inch bit and tripped in hole with bit and drill pipe to re-ream hole back to total depth of 785.0 ft. Unloaded hole using compressed air and re-reamed hole. Rigged up a 19.97-ft joint of PVC (5.5-inch OD and 4.88-inch ID) on a Baker inflatable packer and tripped liner assembly in hole on drill pipe. Placed liner in hole covering an interval from 762.5 ft to 782.5 ft. Deflated the packer. Packer was checked and was free from liner. Moved packer up hole and reinflated above liner to be sure liner was left in hole. Checked out OK. Tripped out packer and drill pipe. Rigged down packer and drill rig. Moved rig off hole to H-19b4. Site secured at 1800 hr.

NOTE: Moved back to H-19b7 on September 5, 1995, to complete geophysical logging of hole.

9-05-95 U.S. Geological Survey on site to complete final geophysical logging. Logs run on H-19b7 included natural gamma, neutron porosity, and caliper. Rigged down from hole and moved to H-19b2.

Operations associated with drilling completed on H-19b7.

Page intentionally left blank.

APPENDIX C

Well Survey Plat

Page intentionally left blank.

PLAT OF SURVEY

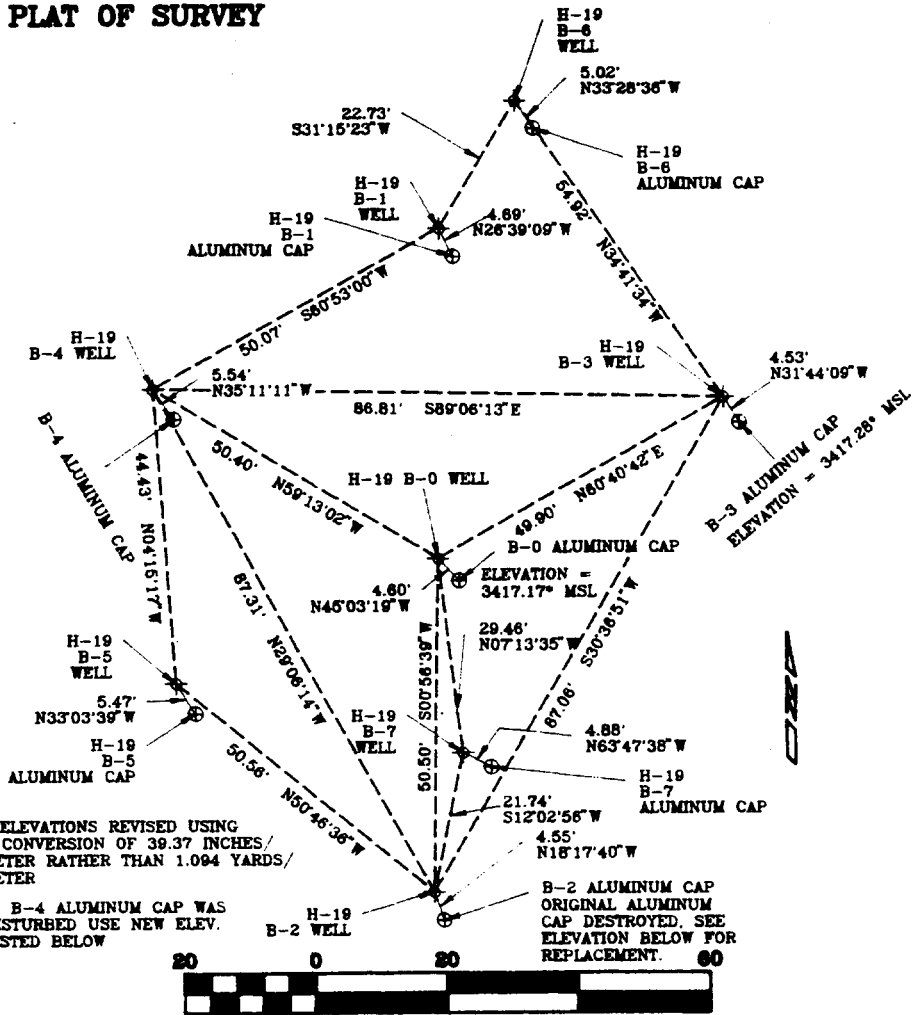

* ELEVATIONS REVISED USING A CONVERSION OF 39.37 INCHES/METER RATHER THAN 1.094 YARDS/METER

** B-4 ALUMINUM CAP WAS DISTURBED USE NEW ELEV. LISTED BELOW

B-2 ALUMINUM CAP ORIGINAL ALUMINUM CAP DESTROYED. SEE ELEVATION BELOW FOR REPLACEMENT.

Scale 1" = 20 ft

COORDINATES:
0.0 NORTH AND 0.0 EAST IS ASSUMED AT THE SW CORNER OF SECTION 28, T22S, R31E, N.M.P.M., EDDY COUNTY, NEW MEXICO.

WELL NO.	NORTHING	EASTING	ELEVATION ALUM. CAP	ELEVATION R.P.	ELEVATION TOP FIBER GLASS CASING
B-0	1484.8	2480.4	3417.17	3417.49	3418.38
B-1	1535.0	2480.8	3417.34	3417.78	NONE
B-2	1434.3	2459.6	3417.06	3417.36	3419.01
B-3	1509.2	2503.9	3417.28	3417.61	3419.09
B-4	1510.6	2417.1	3416.37**	NONE	3419.03
B-5	1466.3	2420.4	3417.00	3417.29	3418.63
B-6	1654.4	2472.6	3417.18	3417.50	3419.07
B-7	1455.6	2464.1	3417.17	3417.27	3418.99

CERTIFICATION:
THIS IS TO CERTIFY THAT THE FOREGOING PLAT WAS MADE FROM FIELD NOTES OF A-RONA FIDE SURVEY, MADE BY ME, MEETING THE MINIMUM STANDARDS FOR SURVEYING IN NEW MEXICO, AND IS TRUE AND CORRECT TO THE BEST OF MY KNOWLEDGE AND BELIEF.

Dan R. Reddy
DAN R. REDDY NM PE&PS NO. 5412
401 W. GREENE ST./P.O. BOX 597
CARLSBAD, NEW MEXICO 88221
JULY 17, 1995 (REVISED 7/25/95)
PREPARED FOR: SANDIA LABORATORIES
REVISED: OCT. 17, 1995



Page intentionally left blank.

APPENDIX D

Well Permits and Records

Page intentionally left blank.

IMPORTANT-READ INSTRUCTIONS ON BACK BEFORE FILLING OUT THIS FORM

APPLICATION FOR PERMIT

To Appropriate the Underground Waters of the State of New Mexico

- Date Received November 14, 1994 File No. C-2420
- Name of applicant U. S. Department of Energy, Carlsbad Area Office
Mailing address P. O. Box 3090
City and State Carlsbad, New Mexico 88221-3090
 - Source of water supply Artesian, located in Carlsbad Basin
(artesian or shallow water aquifer) (name of underground basin)
 - The well is to be located in the SE $\frac{1}{4}$ NE $\frac{1}{4}$ SW $\frac{1}{4}$, Section 28 Township 22S
Range 31E N.M.P.M., or Tract No. _____ of Map No. _____ of the _____ District,
on land owned by U. S. Department of Energy
 - Description of well: name of driller H-19b1, Test Well, NM Licensed driller being selected
Outside Diameter of casing 9.12 inches; Approximate depth to be drilled 790 feet;
 - Quantity of water to be appropriated and beneficially used Consumptive, 10 acre feet,
(consumptive use, diversion)
for Hydrologic characterization and testing purposes.
 - Acreage to be irrigated or place of use N/A acres.

Subdivision	Section	Township	Range	Acres	Owner

- Additional statements or explanations:
 - Item 3 A pre-drilling survey is attached.
 - Item 4 The contract selection process for a New Mexico licensed driller is underway. A well design with approximate depths is attached.
 - Item 5 The hole will be completed in the Rustler Formation. This hole will be used for long-term monitoring and testing of the hydrologic characteristics of the Culebra member of the Rustler Formation. Over the lifetime of the testing period of this well, 2-3 years, approximately 20 acre feet will be used consumptively. This well is to be the pumping well for multiwell hydrologic tracer tests. (Request to use tracers being processed separately.) The data from these tests is to be used in the WIPP performance assessment.
- Note: An amended form or a letter will be sent to the State Engineer's office if and when any significant additions to the information enclosed are necessary.

I, Harold F. Klaus Jr., affirm that the foregoing statements are true to the best of my knowledge and belief and that development shall not commence until approval of the permit has been obtained.

U.S. Department of Energy, Permittee,

By: [Signature]

Subscribed and sworn to before me this Ninth day of November, A.D., 1994

My commission expires April 29, 1997

[Signature]
Notary Public

2150
111126

Number of this permit C-2420

ACTION OF STATE ENGINEER

After notice pursuant to statute and by authority vested in me, this application is approved provided it is not exercised to the detriment of any others having existing rights; further provided that all rules and regulations of the State Engineer pertaining to the drilling of artesian wells be complied with; and further subject to the following conditions:

SEE ATTACHED CONDITIONS OF APPROVAL

Proof of completion of well shall be filed on or before N/A, 19

Proof of application of water to beneficial use shall be filed on or before N/A, 19

Witness my hand and seal this 25TH day of January, A.D., 1995

D. T. Lopez, Acting State Engineer

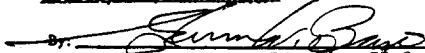
By: 
Glenn W. Brim, District II Supervisor

INSTRUCTIONS

This form shall be executed, preferably typewritten, in triplicate and shall be accompanied by a filing fee of \$5.00. Each of triplicate copies must be properly signed and attested.

A separate application for permit must be filed for each well used.

Secs. 1-4—Fill out all blanks fully and accurately.

Sec. 5—Irrigation use shall be stated in acre feet of water per acre per annum to be applied on the land. If for municipal or other purposes, state total quantity in acre feet to be used annually.

Sec. 6—Describe only the lands to be irrigated or where water will be used. If on unsurveyed lands describe by legal subdivision "as projected" from the nearest government survey corners, or describe by metes and bounds and tie survey to some permanent, easily located natural object.

Sec. 7—If lands are irrigated from any other source, explain in this section. Give any other data necessary to fully describe water right sought.

PLAT OF SURVEY

DRILL HOLE LOCATION FOR WIPP H-19: 1473 FROM SOUTH LINE AND 2459 FEET FROM THE WEST LINE, SEC. 28, T22S, R31E, N.M.P.M., EDDY COUNTY, NEW MEXICO.

R-31-E

T
22
S

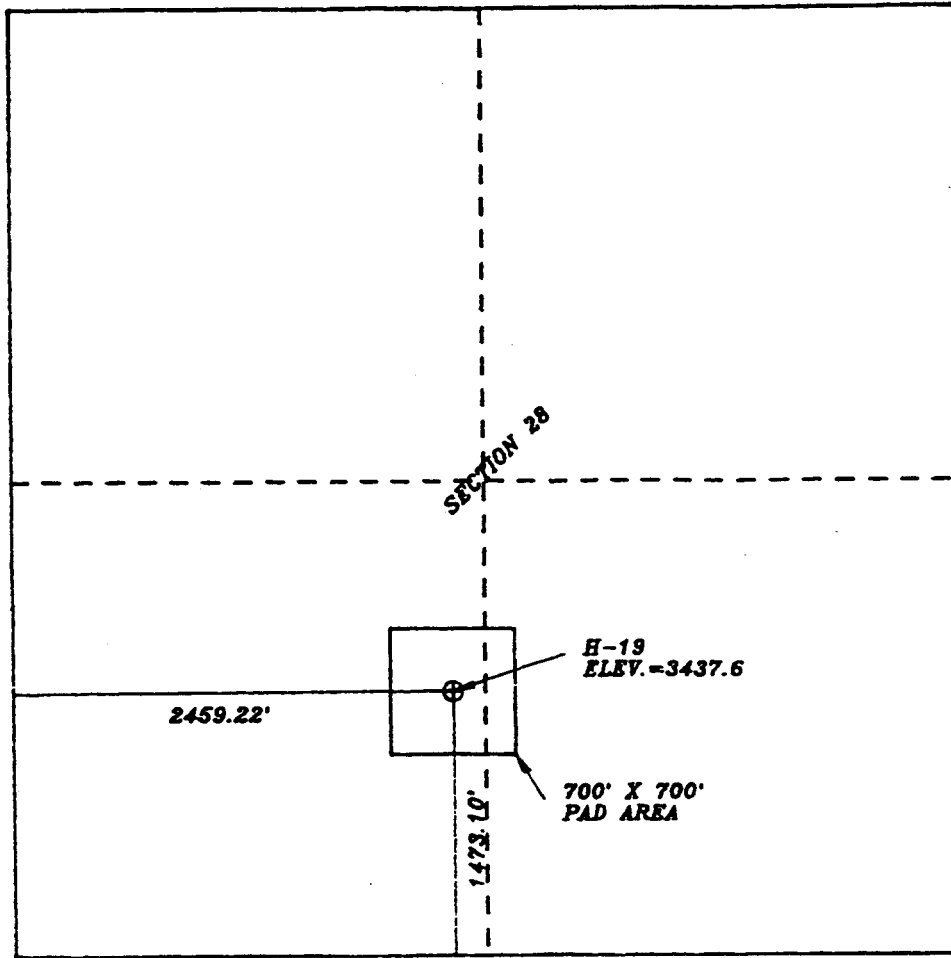

94 NOV 14 11 1 25



Scale 1" = 1000 ft

CERTIFICATION:

THIS IS TO CERTIFY THAT THE FOREGOING PLAT WAS MADE FROM FIELD NOTES OF A BONA FIDE SURVEY, MADE BY ME, MEETING THE MINIMUM STANDARDS FOR SURVEYING IN NEW MEXICO, AND IS TRUE AND CORRECT TO THE BEST OF MY KNOWLEDGE AND BELIEF.

Dan R. Reddy

DAN R. REDDY NY YEARS NO. 5412
401 W. GREENE ST./P.O. BOX 697
CARLSBAD, NEW MEXICO 88220
JULY 14, 1984

PREPARED FOR: SANDIA LABORATORIES



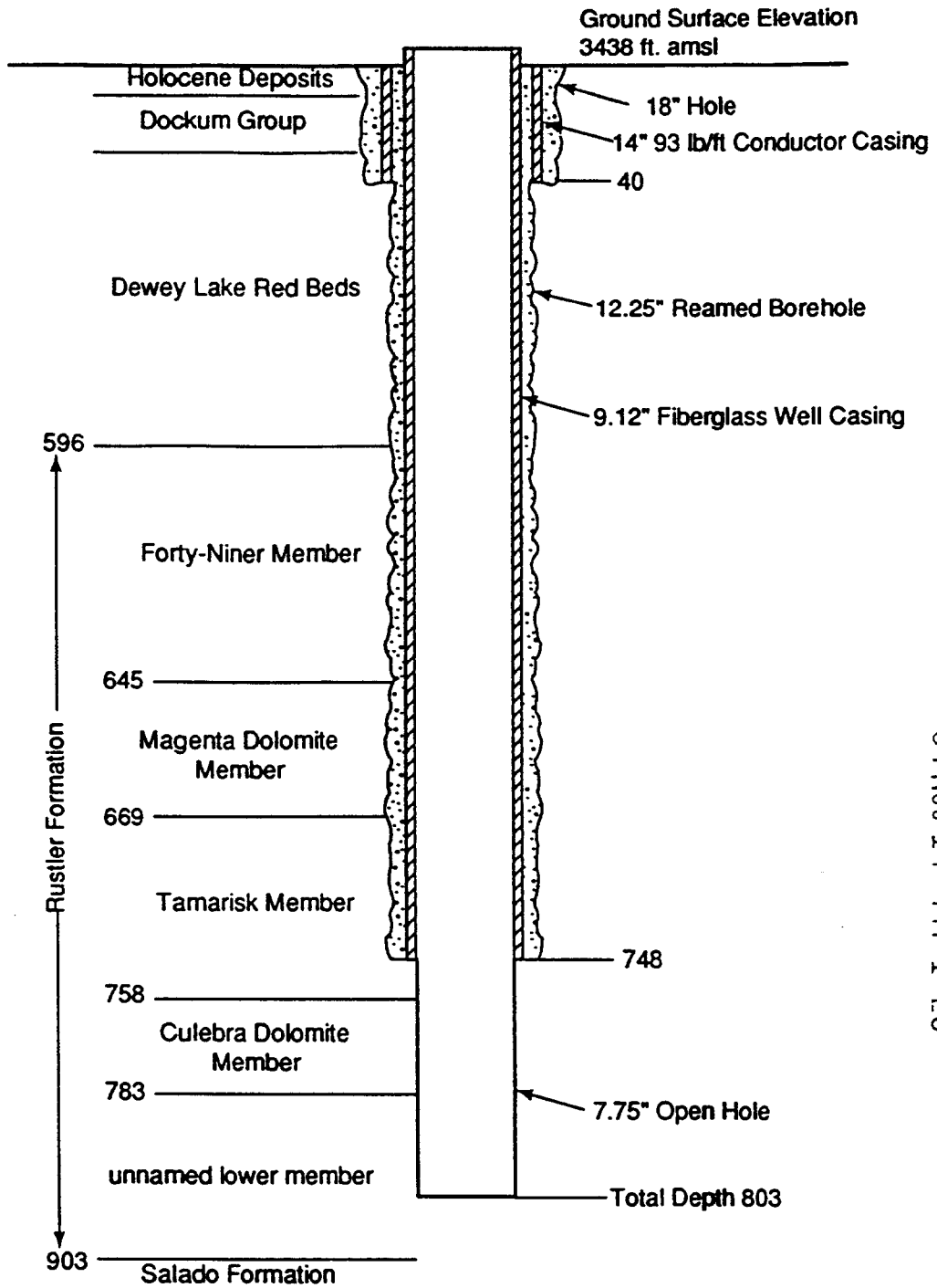

911800 11 1 1 1 25

Note: Depths in feet approximate
Not to Scale

Date: 01/05/94
Ref: JBP/Bhole18/85

TRI-6115-6-3

CONDITIONS OF APPROVAL

PERMIT NO.: C-2420

PERMITTEE: U.S. Department of Energy, Carlsbad Area Office

1. The total diversion of artesian groundwater from the Culebra Member of the Rustler Formation under this permit will be limited to 10.0 acre-feet per annum measured at the well and a total of 20.0 acre-feet per annum measured at the well during the life of this permit.
2. A totalizing meter of a type approved by and installed in a manner and at a location acceptable to the State Engineer shall be installed before the first branch of the discharge line from the well; the State Engineer shall be advised of the make, model, serial number, date of installation, and initial reading of the meter prior to appropriation of water.
3. The permittee shall record the meter reading in writing on the first day of January, April, July, and October of each year on a form acceptable to the State Engineer and submit said reading to the State Engineer on or before the 10th day of January, April, July, and October of each year.
4. The well shall be constructed to artesian specifications. If any deviation from artesian specifications is required, it must be approved by the State Engineer. The State Engineer, District II Office, Roswell, shall be notified a minimum of 48 hours prior to the casing being landed and/or cemented.
5. The State Engineer shall be advised 48 hours in advance of the beginning of any pumping tests.
6. Well C-2420 shall be drilled by a driller licensed in the State of New Mexico in accordance with 72-12-12 New Mexico Statutes annotated.
7. This permit shall terminate upon the completion of the aquifer testing, or on January 31, 1998, whichever is earlier.

350

IMPORTANT-READ INSTRUCTIONS ON BACK BEFORE FILLING OUT THIS FORM

APPLICATION FOR PERMIT

To appropriate the Underground Waters of the State of New Mexico

- Date Received November 14, 1994 File No. C-2421
- Name of applicant U. S. Department of Energy, Carlsbad Area Office
Mailing address P. O. Box 3090
City and State Carlsbad, NM 88221-3090
 - Source of water supply Artesian, located in Carlsbad Basin
(artesian or shallow water aquifer) (name of underground basin)
 - The well is to be located in the SE $\frac{1}{4}$ NE $\frac{1}{4}$ SW $\frac{1}{4}$, Section 28, Township 22 S
Range 31 E N.M.P.M., or Tract No. _____ of Map No. _____ of the _____ District,
on land owned by U. S. Department of Energy
 - Description of well: name of driller H-19b2, Test Well, N.M. Licensed Driller Being Selected
Outside Diameter of casing 7 inches; Approximate depth to be drilled 790 feet;
 - Quantity of water to be appropriated and beneficially used Consumptive, 1 acre feet,
(consumptive use, diversion)
for Hydrologic characterization and testing purposes.
 - Acres to be irrigated or place of use N/A acres.

Subdivision	Section	Township	Range	Acres	Owner

- Additional statements or explanations

Item 4 The contract selection process for a New Mexico licensed driller is underway. A well design with approximate depths is attached.

Item 5 The hole will be completed in the Rustler Formation. This hole will be used for long-term monitoring and testing of the hydrologic characteristics of the Culebra member of the Rustler Formation. Over the lifetime of the testing period of this well, 2-3 years, approximately 2 acre feet will be used consumptively. This well is to be primarily an injection well for multiwell hydrologic tracer tests. (Request to use tracers being processed separately.) The data from these tests is to be used in the WIPP performance assessment.

Note: An amended form or a letter will be sent to the State Engineer's Office if an when any significant additions to the information enclosed are necessary.

I, Harold E. Klaus Jr, affirm that the foregoing statements are true to the best of my knowledge and belief and that development shall not commence until approval of the permit has been obtained.

U.S. Department of Energy, Permittee,
By: [Signature]

Subscribed and sworn to before me this Ninth day of November, A.D., 19 94.

My commission expires April 29, 1997 [Signature]
Notary Public

Number of this permit C-2421

ACTION OF STATE ENGINEER

After notice pursuant to statute and by authority vested in me, this application is approved provided it is not exercised to the detriment of any others having existing rights; further provided that all rules and regulations of the State Engineer pertaining to the drilling of artesian wells be complied with; and further subject to the following conditions:

SEE ATTACHED CONDITIONS OF APPROVAL

Proof of completion of well shall be filed on or before N/A, 19

Proof of application of water to beneficial use shall be filed on or before N/A, 19

Witness my hand and seal this 25TH day of January, A.D., 1995

D.T. Lopez, Acting State Engineer

~~State Engineer~~

By: Glenn W. Brim
Glenn W. Brim, District II Supervisor

INSTRUCTIONS

This form shall be executed, preferably typewritten, in triplicate and shall be accompanied by a filing fee of \$5.00. Each of triplicate copies must be properly signed and attested.

A separate application for permit must be filed for each well used.

Secs. 1-4—Fill out all blanks fully and accurately.

Sec. 5—Irrigation use shall be stated in acre feet of water per acre per annum to be applied on the land. If for municipal or other purposes, state total quantity in acre feet to be used annually.

Sec. 6—Describe only the lands to be irrigated or where water will be used. If on unsurveyed lands describe by legal subdivision "as projected" from the nearest government survey corners, or describe by metes and bounds and tie survey to some permanent, easily located natural object.

Sec. 7—If lands are irrigated from any other source, explain in this section. Give any other data necessary to fully describe water right sought.

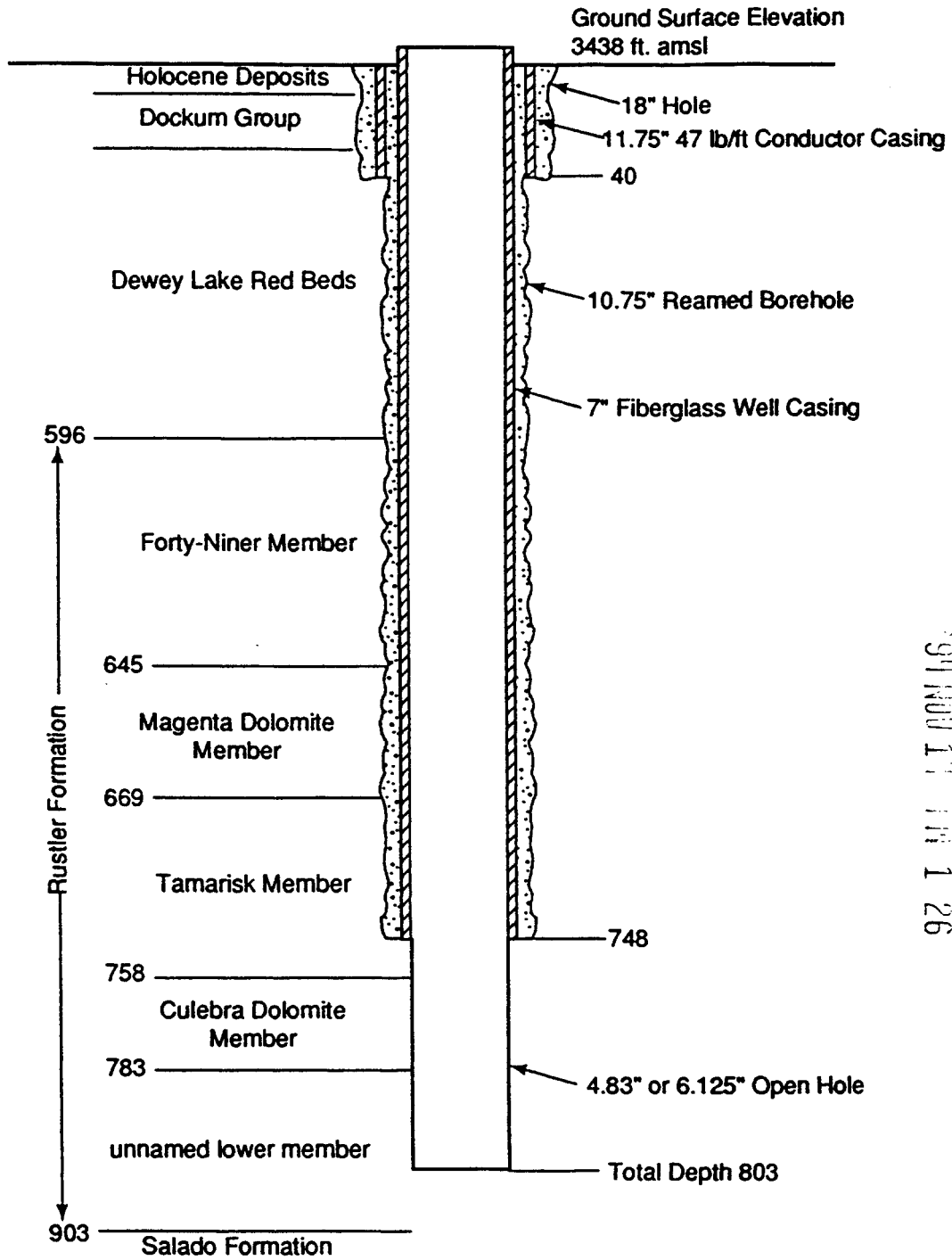

94 NOV 17 11 1 26
 0100

Note: Depths in feet approximate
Not to Scale

Date: 01/05/94
Ref: JBP/Bhole18/85

TRI-6115-6-2

CONDITIONS OF APPROVAL

PERMIT NO.: C-2421

PERMITTEE: U.S. Department of Energy, Carlsbad Area Office

1. The total diversion of artesian groundwater from the Culebra Member of the Rustler Formation under this permit will be limited to 1.0 acre-foot per annum measured at the well and a total of 2.0 acre-feet per annum measured at the well during the life of this permit.
2. A totalizing meter of a type approved by and installed in a manner and at a location acceptable to the State Engineer shall be installed before the first branch of the discharge line from the well; the State Engineer shall be advised of the make, model, serial number, date of installation, and initial reading of the meter prior to appropriation of water.
3. The permittee shall record the meter reading in writing on the first day of January, April, July, and October of each year on a form acceptable to the State Engineer and submit said reading to the State Engineer on or before the 10th day of January, April, July, and October of each year.
4. The well shall be constructed to artesian specifications. If any deviation from artesian specifications is required, it must be approved by the State Engineer. The State Engineer, District II Office, Roswell, shall be notified a minimum of 48 hours prior to the casing being landed and/or cemented.
5. The State Engineer shall be advised 48 hours in advance of the beginning of any pumping tests.
6. Well C-2421 shall be drilled by a driller licensed in the State of New Mexico in accordance with 72-12-12 New Mexico Statutes annotated.
7. This permit shall terminate upon the completion of the aquifer testing, or on January 31, 1998, whichever is earlier.

IMPORTANT-READ INSTRUCTIONS ON BACK BEFORE FILLING OUT THIS FORM

APPLICATION FOR PERMIT

To Appropriate the Underground Waters of the State of New Mexico

- Date Received November 14, 1994 File No. C-2422
1. Name of applicant U. S. Department of Energy, Carlsbad Area Office
 Mailing address P. O. Box 3090
 City and State Carlsbad, NM 88221-3090
2. Source of water supply Artesian, located in Carlsbad Basin
 (artesian or shallow water aquifer) (name of underground basin)
3. The well is to be located in the SE $\frac{1}{4}$ NE $\frac{1}{4}$ SW $\frac{1}{4}$, Section 28 Township 22 S
 Range 31 E N.M.P.M., or Tract No. _____ of Map No. _____ of the _____ District,
 on land owned by U. S. Department of Energy
4. Description of well: name of driller H-19b3, Test Well, N.M. Licensed Driller Being Selected
 Outside Diameter of casing 7 inches; Approximate depth to be drilled 790 feet;
5. Quantity of water to be appropriated and beneficially used Consumptive, 1 acre feet,
 (consumptive use, diversion)
 for Hydrologic characterization and testing purposes.
6. Acreage to be irrigated or place of use N/A acres.

Subdivision	Section	Township	Range	Acres	Owner

7. Additional statements or explanations.
- Item 4 The contract selection process for a New Mexico licensed driller is underway. A well design with approximate depths is attached.
- Item 5 The hole will be completed in the Rustler Formation. This hole will be used for long-term monitoring and testing of the hydrologic characteristics of the Culebra member of the Rustler Formation. Over the lifetime of the testing period of this well, 2-3 years, approximately 2 acre feet will be used consumptively. This well is to be primarily an injection well for multiwell hydrologic tracer tests. (Request to use tracers being processed separately.) The data from these tests is to be used in the WIPP performance assessment.
- Note: An amended form or a letter will be sent to the State Engineer's Office if an when any significant additions to the information enclosed are necessary.

I, Harold F. Klaus Jr, affirm that the foregoing statements are true to the best of my knowledge and belief and that development shall not commence until approval of the permit has been obtained.

U.S. Department of Energy, Permittee,
By: [Signature]

Subscribed and sworn to before me this Ninth day of November, A.D., 1994

My commission expires April 29, 1997 [Signature]
Notary Public

Number of this permit C-2422

ACTION OF STATE ENGINEER

After notice pursuant to statute and by authority vested in me, this application is approved provided it is not exercised to the detriment of any others having existing rights; further provided that all rules and regulations of the State Engineer pertaining to the drilling of artesian wells be complied with; and further subject to the following conditions:

SEE ATTACHED CONDITIONS OF APPROVAL

Proof of completion of well shall be filed on or before N/A, 19

Proof of application of water to beneficial use shall be filed on or before N/A, 19

Witness my hand and seal this 25th day of January, A.D., 1925

D.T. Lopez, Acting State Engineer

By: *Glenn W. Brim*
Glenn W. Brim, District 11 Supervisor

INSTRUCTIONS

This form shall be executed, preferably typewritten, in triplicate and shall be accompanied by a filing fee of \$5.00. Each of triplicate copies must be properly signed and attested.

A separate application for permit must be filed for each well used.

Secs. 1-4—Fill out all blanks fully and accurately.

Sec. 5—Irrigation use shall be stated in acre feet of water per acre per annum to be applied on the land. If for municipal or other purposes, state total quantity in acre feet to be used annually.

Sec. 6—Describe only the lands to be irrigated or where water will be used. If on unsurveyed lands describe by legal subdivision "as projected" from the nearest government survey corners, or describe by metes and bounds and tie survey to some permanent, easily located natural object.

Sec. 7—If lands are irrigated from any other source, explain in this section. Give any other data necessary to fully describe water right sought.

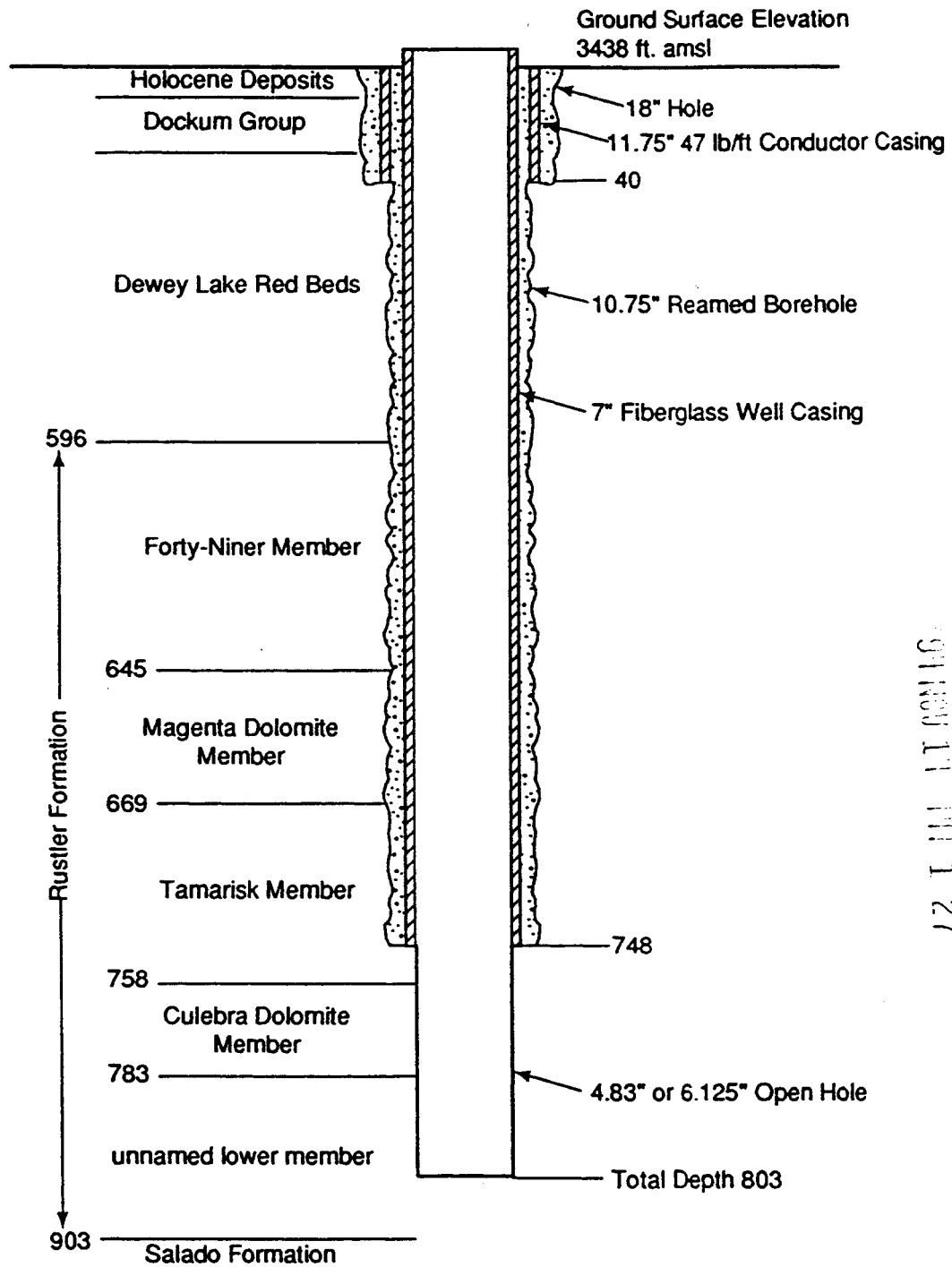

01/05/94 11:11:1 27

4117
 4118
 4119

Note: Depths in feet approximate
Not to Scale

Date: 01/05/94
Ref: JBP/Bhole18/85

TRI-6115-6-2

CONDITIONS OF APPROVAL

PERMIT NO.: C-2422

PERMITTEE: U.S. Department of Energy, Carlsbad Area Office

1. The total diversion of artesian groundwater from the Culebra Member of the Rustler Formation under this permit will be limited to 1.0 acre-foot per annum measured at the well and a total of 2.0 acre-feet per annum measured at the well during the life of this permit.
2. A totalizing meter of a type approved by and installed in a manner and at a location acceptable to the State Engineer shall be installed before the first branch of the discharge line from the well; the State Engineer shall be advised of the make, model, serial number, date of installation, and initial reading of the meter prior to appropriation of water.
3. The permittee shall record the meter reading in writing on the first day of January, April, July, and October of each year on a form acceptable to the State Engineer and submit said reading to the State Engineer on or before the 10th day of January, April, July, and October of each year.
4. The well shall be constructed to artesian specifications. If any deviation from artesian specifications is required, it must be approved by the State Engineer. The State Engineer, District II Office, Roswell, shall be notified a minimum of 48 hours prior to the casing being landed and/or cemented.
5. The State Engineer shall be advised 48 hours in advance of the beginning of any pumping tests.
6. Well C-2422 shall be drilled by a driller licensed in the State of New Mexico in accordance with 72-12-12 New Mexico Statutes annotated.
7. This permit shall terminate upon the completion of the aquifer testing, or on January 31, 1998, whichever is earlier.

IMPORTANT-READ INSTRUCTIONS ON BACK BEFORE FILLING OUT THIS FORM

APPLICATION FOR PERMIT

To Appropriate the Underground Waters of the State of New Mexico

- Date Received November 14, 1994 File No. C-2423
1. Name of applicant U. S. Department of Energy, Carlsbad Area Office
 Mailing address P. O. Box 3090
 City and State Carlsbad, NM 88221-3090
2. Source of water supply Artesian, located in Carlsbad Basin
(artesian or shallow water aquifer) (name of underground basin)
3. The well is to be located in the SE $\frac{1}{4}$ NE $\frac{1}{4}$ SW $\frac{1}{4}$, Section 28 Township 22 S
 Range 31 E N.M.P.M., or Tract No. _____ of Map No. _____ of the _____ District,
 on land owned by U. S. Department of Energy
4. Description of well: name of driller H-19b4, Test Well, N.M. Licensed Driller Being Selected
 Outside Diameter of casing 7 inches; Approximate depth to be drilled 790 feet;
5. Quantity of water to be appropriated and beneficially used Consumptive, 1 acre feet,
(consumptive use, diversion)
 for Hydrologic characterization and testing purposes.
6. Acreage to be irrigated or place of use N/A acres.

Subdivision	Section	Township	Range	Acres	Owner

7. Additional statements or explanations
- Item 4 The contract selection process for a New Mexico licensed driller is underway. A well design with approximate depths is attached.
- Item 5 The hole will be completed in the Rustler Formation. This hole will be used for long-term monitoring and testing of the hydrologic characteristics of the Culbraz member of the Rustler Formation. Over the lifetime of the testing period of this well, 2-3 years, approximately 2 acre feet will be used consumptively. This well is to be primarily an injection well for multiwell hydrologic tracer tests. (Request to use tracers being processed separately.) The data from these tests is to be used in the WIPP performance assessment.
- Note: An amended form or a letter will be sent to the State Engineer's Office if an when any significant additions to the information enclosed are necessary.

I, Harold F. Klaus, Jr., affirm that the foregoing statements are true to the best of my knowledge and belief and that development shall not commence until approval of the permit has been obtained.

U.S. Department of Energy, Permittee,
 By: Harold F. Klaus, Jr.
 Subscribed and sworn to before me this 9th day of November, A.D., 1994.
 My commission expires April 29, 1997 Clara J. Allen
 Notary Public

Number of this permit C-2423

ACTION OF STATE ENGINEER

After notice pursuant to statute and by authority vested in me, this application is approved provided it is not exercised to the detriment of any others having existing rights; further provided that all rules and regulations of the State Engineer pertaining to the drilling of artesian wells be complied with; and further subject to the following conditions:

SEE ATTACHED CONDITIONS OF APPROVAL

Proof of completion of well shall be filed on or before N/A, 19

Proof of application of water to beneficial use shall be filed on or before N/A, 19

Witness my hand and seal this 25TH day of January, A.D., 1995

D.T. Lopez, Acting State Engineer

Glenn W. Brim
By: Glenn W. Brim, District 11 Supervisor

INSTRUCTIONS

- This form shall be executed, preferably typewritten, in triplicate and shall be accompanied by a filing fee of \$5.00. Each of triplicate copies must be properly signed and attested.
- A separate application for permit must be filed for each well used.
- Secs. 1-4—Fill out all blanks fully and accurately.
- Sec. 5—Irrigation use shall be stated in acre feet of water per acre per annum to be applied on the land. If for municipal or other purposes, state total quantity in acre feet to be used annually.
- Sec. 6—Describe only the lands to be irrigated or where water will be used. If on unsurveyed lands describe by legal subdivision "as projected" from the nearest government survey corners, or describe by metes and bounds and tie survey to some permanent, easily located natural object.
- Sec. 7—If lands are irrigated from any other source, explain in this section. Give any other data necessary to fully describe water right sought.

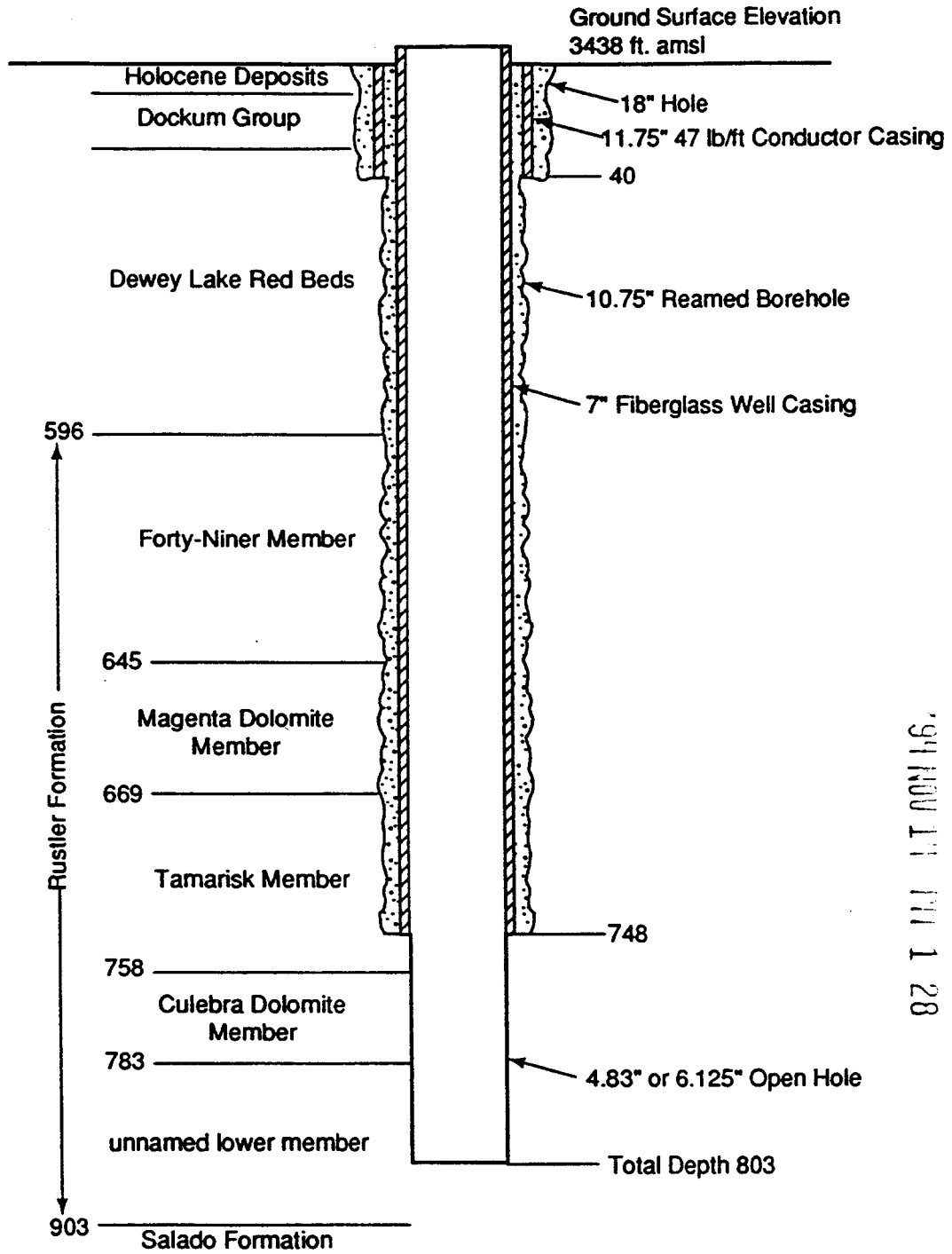

94 NOV 11 PM 1 28

JBP

Note: Depths in feet approximate
Not to Scale

Date: 01/05/94
Ref: JBP/Bhole18/85

TRI-8115-6-2

CONDITIONS OF APPROVAL

PERMIT NO.: C-2423

PERMITTEE: U.S. Department of Energy, Carlsbad Area Office

1. The total diversion of artesian groundwater from the Culebra Member of the Rustler Formation under this permit will be limited to 1.0 acre-foot per annum measured at the well and a total of 2.0 acre-feet per annum measured at the well during the life of this permit.
2. A totalizing meter of a type approved by and installed in a manner and at a location acceptable to the State Engineer shall be installed before the first branch of the discharge line from the well; the State Engineer shall be advised of the make, model, serial number, date of installation, and initial reading of the meter prior to appropriation of water.
3. The permittee shall record the meter reading in writing on the first day of January, April, July, and October of each year on a form acceptable to the State Engineer and submit said reading to the State Engineer on or before the 10th day of January, April, July, and October of each year.
4. The well shall be constructed to artesian specifications. If any deviation from artesian specifications is required, it must be approved by the State Engineer. The State Engineer, District II Office, Roswell, shall be notified a minimum of 48 hours prior to the casing being landed and/or cemented.
5. The State Engineer shall be advised 48 hours in advance of the beginning of any pumping tests.
6. Well C-2423 shall be drilled by a driller licensed in the State of New Mexico in accordance with 72-12-12 New Mexico Statutes annotated.
7. This permit shall terminate upon the completion of the aquifer testing, or on January 31, 1998, whichever is earlier.

2-01765
350-

Revised August 1967

IMPORTANT-READ INSTRUCTIONS ON BACK BEFORE FILLING OUT THIS FORM

APPLICATION FOR PERMIT

To Appropriate the Underground Waters of the State of New Mexico

- Date Received November 14, 1994 File No. C-2424
- Name of applicant U. S. Department of Energy, Carlsbad Area Office
Mailing address P. O. Box 3090
City and State Carlsbad, New Mexico 88221-3090
 - Source of water supply Artesian, located in Carlsbad Basin
(artesian or shallow water aquifer) (name of underground basin)
 - The well is to be located in the S 1/4 ? 1/4 ? 1/4 Section 28 Township 22 S
Range 31 E N.M.P.M., or Tract No. _____ of Map No. _____ of the _____ District
on land owned by U. S. Department of Energy
 - Description of well: name of driller H-19b5, Test Well, N.M. Licensed Driller being selected
Outside Diameter of casing 7 inches; Approximate depth to be drilled 790 feet;
Quantity of water to be appropriated and beneficially used Consumptive, 1 acre feet,
(consumptive use, diversion)
for Hydrologic characterization and testing purposes.
 - Acres to be irrigated or place of use N/A acres.

*K Per
Tillman
Bath
Bennett
11-16-94*

Subdivision	Section	Township	Range	Acres	Owner

- Additional statements or explanations:
 - Item 3 - The exact location of the well is to be determined as a result of hydrologic testing involving H-19b1, H-19b3 and H-19b4 wells (permit applications submitted). Also, because this well may be located on either side of the east-west dividing line of section 28, it is difficult to call out the precise 1/64, 1/16, or even the 1/4 portion of section 28 at this time. However, the well is to be located within the boundary of the H-19 hydropad, a survey of which is enclosed.
 - Item 4 - The contract selection process for a New Mexico licensed driller is underway. A well design with approximate depths is attached.
 - Item 5 - The hole will be completed in the Rustler formation. This hole will be used for long-term monitoring and testing of the hydrologic characteristics of the Culebra member of the Rustler formation. Over the lifetime of the testing period of this well, 2-3 years, approximately 2-3 acre feet will be used consumptively. This well is to be primarily an injection well for multiwell hydrologic tracer tests. (Request to use tracers being processed separately.) The data from these tests is to be used in the WIPP performance assessment.
- Note: An amended form or a letter will be sent to the State Engineer's Office if an when any significant additions to the information enclosed are necessary.

I, Harold F. Klaus Jr., affirm that the foregoing statements are true to the best of my knowledge and belief and that development shall not commence until approval of the permit has been obtained.

U.S. Department of Energy, Permittee,
By: Harold F. Klaus Jr.

Subscribed and sworn to before me this Ninth day of November, A.D., 1994.

My commission expires April 29, 1997
Winnifred J. Allen
Notary Public

Number of this permit C-2424

ACTION OF STATE ENGINEER

After notice pursuant to statute and by authority vested in me, this application is approved provided it is not exercised to the detriment of any others having existing rights; further provided that all rules and regulations of the State Engineer pertaining to the drilling of artesian wells be complied with; and further subject to the following conditions:

SEE ATTACHED CONDITIONS OF APPROVAL

Proof of completion of well shall be filed on or before N/A, 19

Proof of application of water to beneficial use shall be filed on or before N/A, 19

Witness my hand and seal this 25TH day of January, A.D., 1995

D.T. Lopez, Acting State Engineer

~~XXXXXXXXXXXXXXXXXXXX~~
By: Glenn W. Brim
Glenn W. Brim, District II Supervisor

INSTRUCTIONS

This form shall be executed, preferably typewritten, in triplicate and shall be accompanied by a filing fee of \$5.00. Each of triplicate copies must be properly signed and attested.

A separate application for permit must be filed for each well used.

Secs. 1-4—Fill out all blanks fully and accurately.

Sec. 5—Irrigation use shall be stated in acre feet of water per acre per annum to be applied on the land. If for municipal or other purposes, state total quantity in acre feet to be used annually.

Sec. 6—Describe only the lands to be irrigated or where water will be used. If on unsurveyed lands describe by legal subdivision "as projected" from the nearest government survey corners, or describe by metes and bounds and tie survey to some permanent, easily located natural object.

Sec. 7—If lands are irrigated from any other source, explain in this section. Give any other data necessary to fully describe water right sought.

PLAT OF SURVEY

DRILL HOLE LOCATION FOR WIPP H-19: 1473 FROM SOUTH LINE AND 2459 FEET FROM THE WEST LINE, SEC. 28, T22S, R31E, N.M.P.M., EDDY COUNTY, NEW MEXICO.

R-31-E

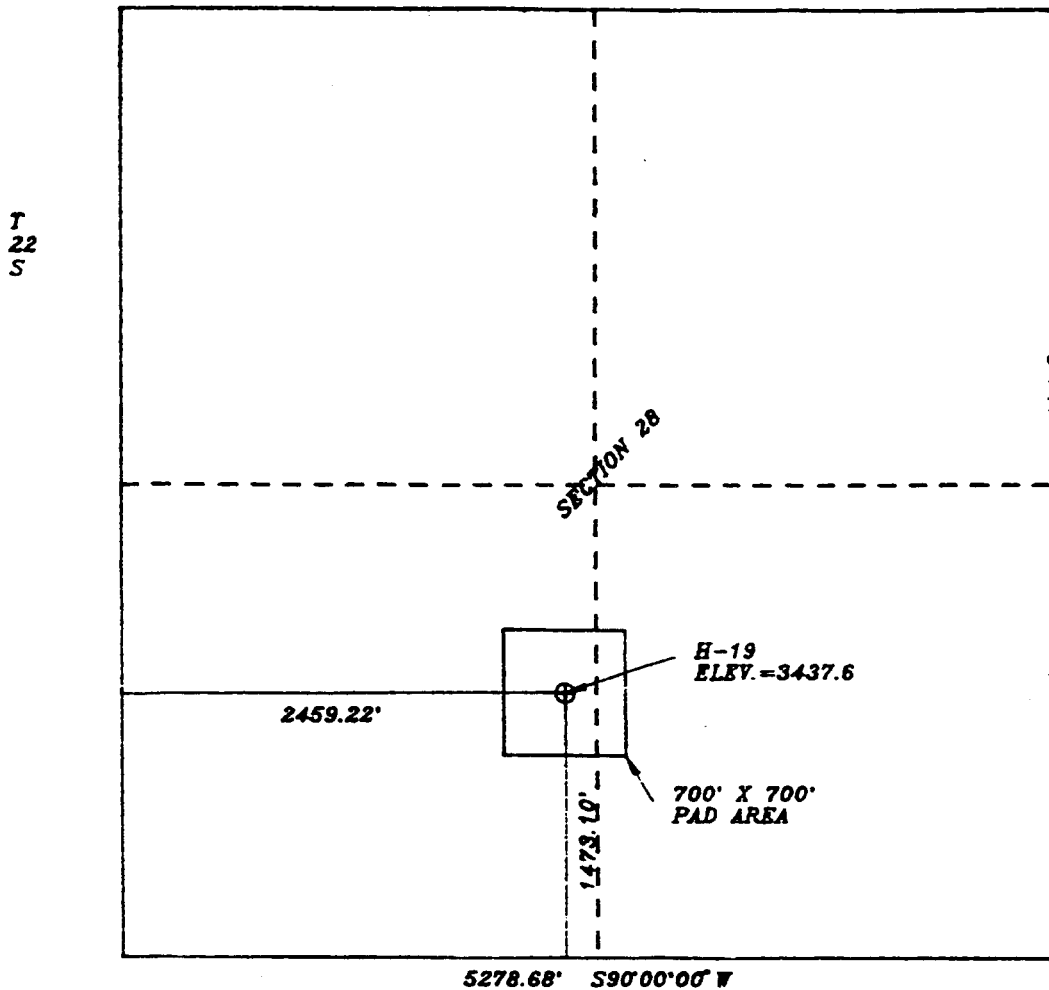

Scale 1" = 1000 ft

CERTIFICATION:

THIS IS TO CERTIFY THAT THE FOREGOING PLAT WAS MADE FROM FIELD NOTES OF A BONA FIDE SURVEY, MADE BY ME, MEETING THE MINIMUM STANDARDS FOR SURVEYING IN NEW MEXICO, AND IS TRUE AND CORRECT TO THE BEST OF MY KNOWLEDGE AND BELIEF.

Dan E. Reddy
DAN E. REDDY N.M. TRAPS NO. 5412
 401 W. GREENE ST./P.O. BOX 697
 CARLSBAD, NEW MEXICO 88220
 JULY 14, 1994
 PREPARED FOR: SANDIA LABORATORIES



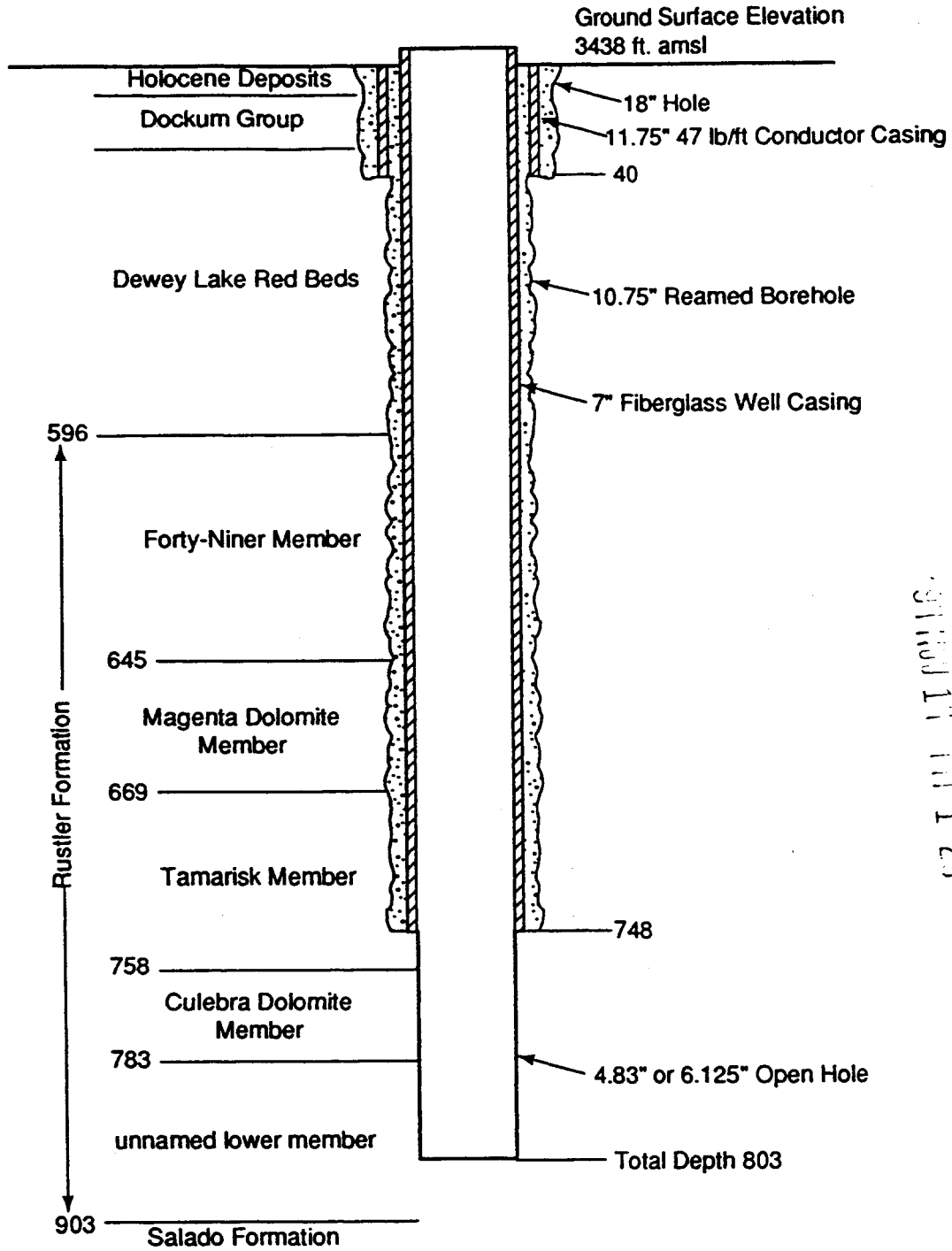

01/05/94
 11:11:29
 091-6115-6-2

Note: Depths in feet approximate
Not to Scale

Date: 01/05/94
Ref: JBP/Bhole18/85

TRI-6115-6-2

CONDITIONS OF APPROVAL

PERMIT NO.: C-2424

PERMITTEE: U.S. Department of Energy, Carlsbad Area Office

1. The total diversion of artesian groundwater from the Culebra Member of the Rustler Formation under this permit will be limited to 1.0 acre-foot per annum measured at the well and a total of 2.0 acre-feet per annum measured at the well during the life of this permit.
2. A totalizing meter of a type approved by and installed in a manner and at a location acceptable to the State Engineer shall be installed before the first branch of the discharge line from the well; the State Engineer shall be advised of the make, model, serial number, date of installation, and initial reading of the meter prior to appropriation of water.
3. The permittee shall record the meter reading in writing on the first day of January, April, July, and October of each year on a form acceptable to the State Engineer and submit said reading to the State Engineer on or before the 10th day of January, April, July, and October of each year.
4. The well shall be constructed to artesian specifications. If any deviation from artesian specifications is required, it must be approved by the State Engineer. The State Engineer, District II Office, Roswell, shall be notified a minimum of 48 hours prior to the casing being landed and/or cemented.
5. The State Engineer shall be advised 48 hours in advance of the beginning of any pumping tests.
6. Well C-2424 shall be drilled by a driller licensed in the State of New Mexico in accordance with 72-12-12 New Mexico Statutes annotated.
7. This permit shall terminate upon the completion of the aquifer testing, or on January 31, 1998, whichever is earlier.

Number of this permit C-2425

ACTION OF STATE ENGINEER

After notice pursuant to statute and by authority vested in me, this application is approved provided it is not exercised to the detriment of any others having existing rights; further provided that all rules and regulations of the State Engineer pertaining to the drilling of artesian wells be complied with; and further subject to the following conditions:

SEE ATTACHED CONDITIONS OF APPROVAL

Proof of completion of well shall be filed on or before N/A, 1995

Proof of application of water to beneficial use shall be filed on or before N/A, 1995

Witness my hand and seal this 25TH day of January, A.D., 1995

D. T. Lopez, Acting State Engineer
~~State Engineer~~

By: Glenn W. Brim
Glenn W. Brim, District II Supervisor

INSTRUCTIONS

- This form shall be executed, preferably typewritten, in triplicate and shall be accompanied by a filing fee of \$5.00. Each of triplicate copies must be properly signed and attested.
- A separate application for permit must be filed for each well used.
- Secs. 1-4—Fill out all blanks fully and accurately.
- Sec. 5—Irrigation use shall be stated in acre feet of water per acre per annum to be applied on the land. If for municipal or other purposes, state total quantity in acre feet to be used annually.
- Sec. 6—Describe only the lands to be irrigated or where water will be used. If on unsurveyed lands describe by legal subdivision "as projected" from the nearest government survey corners, or describe by metes and bounds and tie survey to some permanent, easily located natural object.
- Sec. 7—If lands are irrigated from any other source, explain in this section. Give any other data necessary to fully describe water right sought.

PLAT OF SURVEY

DRILL HOLE LOCATION FOR WIPP H-19: 1473 FROM SOUTH LINE AND 2459 FEET FROM THE WEST LINE, SEC. 28, T22S, R31E, N.M.P.M., EDDY COUNTY, NEW MEXICO.

R-31-E

T
22
S

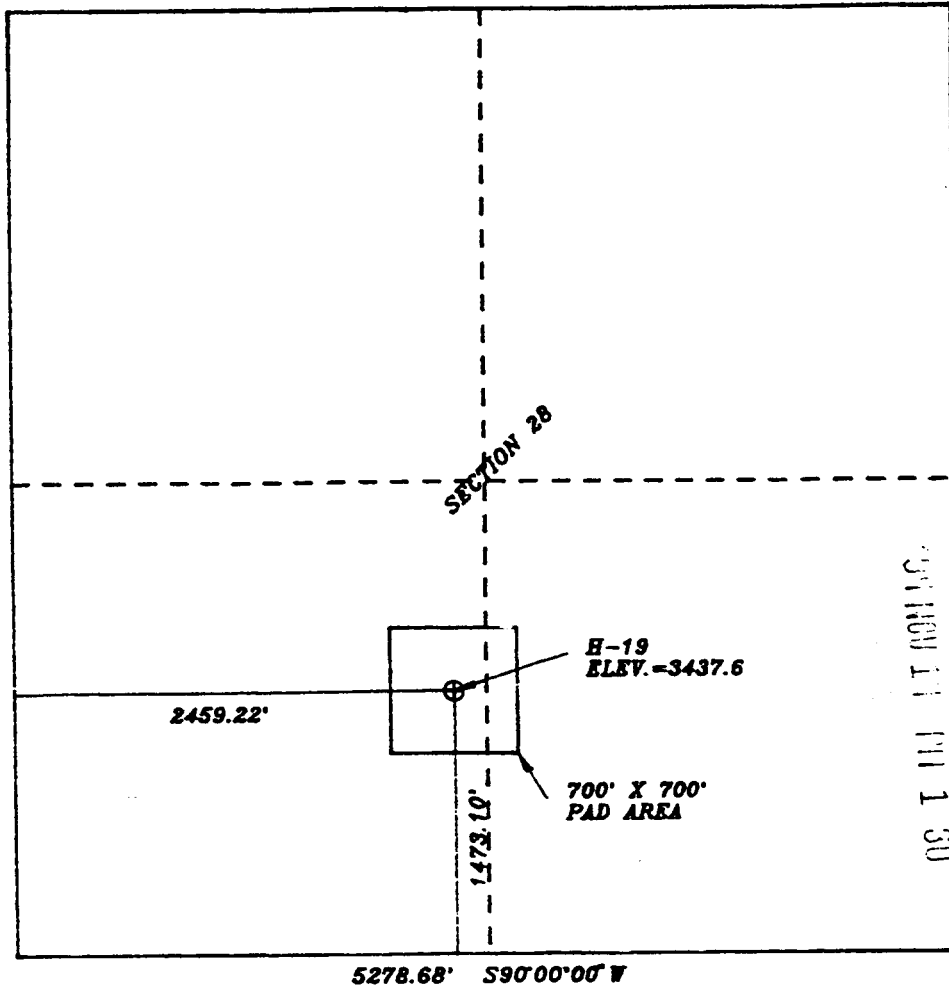

Scale 1" = 1000 ft

CERTIFICATION:
THIS IS TO CERTIFY THAT THE FOREGOING PLAT WAS MADE FROM FIELD NOTES OF A BONA FIDE SURVEY, MADE BY ME, MEETING THE MINIMUM STANDARDS FOR SURVEYING IN NEW MEXICO, AND IS TRUE AND CORRECT TO THE BEST OF MY KNOWLEDGE AND BELIEF.

Dan R. Reddy
DAN R. REDDY NM TRAPS NO. 5412
401 W. GREENE ST./P.O. BOX 607
CARLSBAD, NEW MEXICO 88220
JULY 14, 1994
PREPARED FOR: SANDIA LABORATORIES



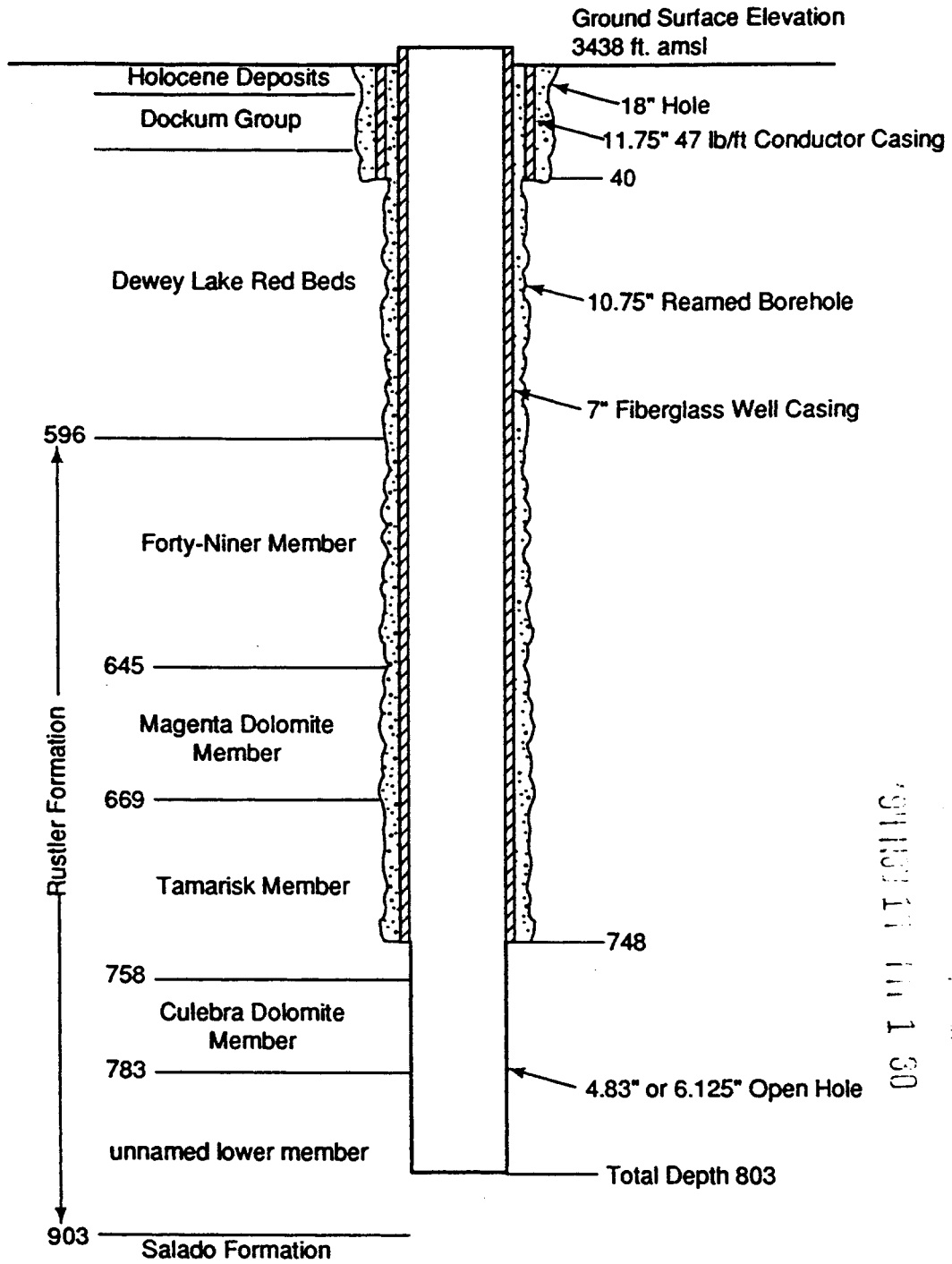

01/05/94
 JBP/Bhole18/85
 TRI-6115-6-2

Note: Depths in feet approximate
Not to Scale

Date: 01/05/94
Ref: JBP/Bhole18/85

TRI-6115-6-2

CONDITIONS OF APPROVAL

PERMIT NO.: C-2425

PERMITTEE: U.S. Department of Energy, Carlsbad Area Office

1. The total diversion of artesian groundwater from the Culebra Member of the Rustler Formation under this permit will be limited to 1.0 acre-foot per annum measured at the well and a total of 2.0 acre-feet per annum measured at the well during the life of this permit.
2. A totalizing meter of a type approved by and installed in a manner and at a location acceptable to the State Engineer shall be installed before the first branch of the discharge line from the well; the State Engineer shall be advised of the make, model, serial number, date of installation, and initial reading of the meter prior to appropriation of water.
3. The permittee shall record the meter reading in writing on the first day of January, April, July, and October of each year on a form acceptable to the State Engineer and submit said reading to the State Engineer on or before the 10th day of January, April, July, and October of each year.
4. The well shall be constructed to artesian specifications. If any deviation from artesian specifications is required, it must be approved by the State Engineer. The State Engineer, District II Office, Roswell, shall be notified a minimum of 48 hours prior to the casing being landed and/or cemented.
5. The State Engineer shall be advised 48 hours in advance of the beginning of any pumping tests.
6. Well C-2425 shall be drilled by a driller licensed in the State of New Mexico in accordance with 72-12-12 New Mexico Statutes annotated.
7. This permit shall terminate upon the completion of the aquifer testing, or on January 31, 1998, whichever is earlier.

IMPORTANT-READ INSTRUCTIONS ON BACK BEFORE FILLING OUT THIS FORM

APPLICATION FOR PERMIT

To appropriate the Underground Waters of the State of New Mexico

Date Received November 14, 1994 File No. C-2426

1. Name of applicant U. S. Department of Energy, Carlsbad Area Office

Mailing address P. O. Box 3090

City and State Carlsbad, New Mexico 88221-3090

2. Source of water supply Artesian, located in Carlsbad Basin
(artesian or shallow water aquifer) (name of underground basin)

3. The well is to be located in the SE 1/4 of Section 28 Township 22 S Range 31 E N.M.P.M., or Tract No. _____ of Map No. _____ of the _____ District on land owned by U. S. Department of Energy

4. Description of well: name of driller H-19b7, Test Well, N.M. Licensed Driller being selected
Outside Diameter of casing 7 inches; Approximate depth to be drilled 790 feet;

5. Quantity of water to be appropriated and beneficially used Consumptive, 1 acre feet,
(consumptive use, diversion)
for Hydrologic characterization and testing purposes.

6. Acreage to be irrigated or place of use N/A acres.

Subdivision	Section	Township	Range	Acres	Owner

7. Additional statements or explanations.

Item 3 - The exact location of the well is to be determined as a result of hydrologic testing involving H-19b1, H-19b3 and H-19b4 wells (permit applications submitted). Also, because this well may be located on either side of the east-west dividing line of section 28, it is difficult to call out the precise 1/64, 1/16, or even the 1/4 portion of section 28 at this time. However, the well is to be located within the boundary of the H-19 hydropad, a survey of which is enclosed.

Item 4 - The contract selection process for a New Mexico licensed driller is underway. A well design with approximate depths is attached.

Item 5 - The hole will be completed in the Rustler formation. This hole will be used for long-term monitoring and testing of the hydrologic characteristics of the Culebra member of the Rustler formation. Over the lifetime of the testing period of this well, 2-3 years, approximately 2-3 acre feet will be used consumptively. This well is to be primarily an injection well for multiwell hydrologic tracer tests. (Request to use tracers being processed separately.) The data from these tests is to be used in the WIPP performance assessment.

Note: An amended form or a letter will be sent to the State Engineer's Office if and when any significant additions to the information enclosed are necessary.

I, Harold F. Klaus Jr., affirm that the foregoing statements are true to the best of my knowledge and belief and that development shall not commence until approval of the permit has been obtained.

U.S. Department of Energy, Permittee,

By: [Signature]

Subscribed and sworn to before me this Ninth day of November, A.D., 1994

My commission expires April 29, 1997
[Signature]
Notary Public

Number of this permit: C-2426

ACTION OF STATE ENGINEER

After notice pursuant to statute and by authority vested in me, this application is approved provided it is not exercised to the detriment of any others having existing rights; further provided that all rules and regulations of the State Engineer pertaining to the drilling of artesian wells be complied with; and further subject to the following conditions:

SEE ATTACHED CONDITIONS OF APPROVAL

Proof of completion of well shall be filed on or before N/A, 19

Proof of application of water to beneficial use shall be filed on or before N/A, 19

Witness my hand and seal this 25TH day of January, A.D., 19 95

D.T. Lopez, Acting State Engineer

By: 
Glenn W. Brim, District II Supervisor

INSTRUCTIONS

This form shall be executed, preferably typewritten, in triplicate and shall be accompanied by a filing fee of \$5.00. Each of triplicate copies must be properly signed and attested.

A separate application for permit must be filed for each well used.

Secs. 1-4—Fill out all blanks fully and accurately.

Sec. 5—Irrigation use shall be stated in acre feet of water per acre per annum to be applied on the land. If for municipal or other purposes, state total quantity in acre feet to be used annually.

Sec. 6—Describe only the lands to be irrigated or where water will be used. If on unsurveyed lands describe by legal subdivision "as projected" from the nearest government survey corners, or describe by metes and bounds and tie survey to some permanent, easily located natural object.

Sec. 7—If lands are irrigated from any other source, explain in this section. Give any other data necessary to fully describe water right sought.

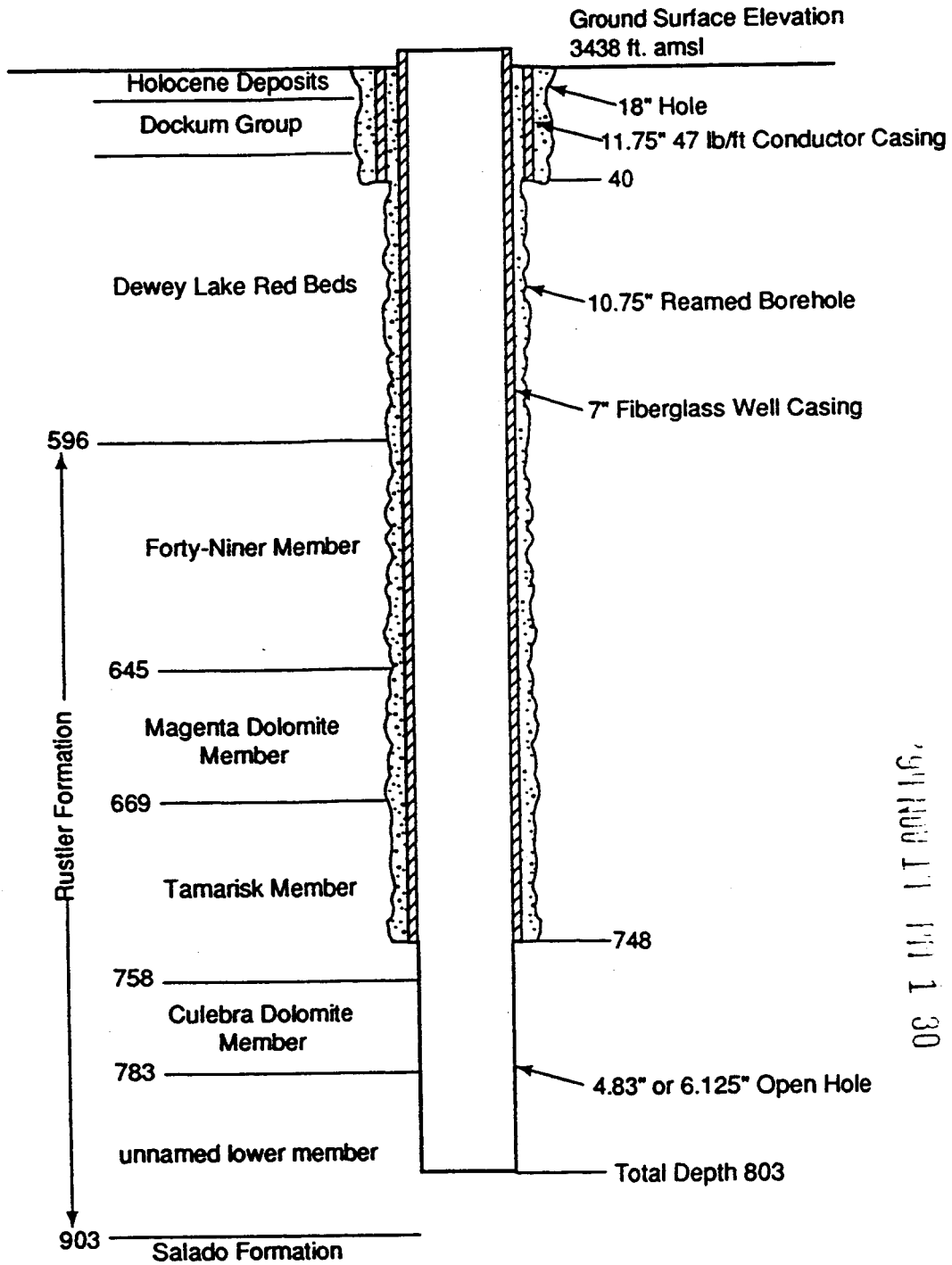

Note: Depths in feet approximate
Not to Scale

Date: 01/05/94
Ref: JBP/Bhole18/85

TRI-6115-6-2

CONDITIONS OF APPROVAL

PERMIT NO. : C-2426

PERMITTEE: U.S. Department of Energy, Carlsbad Area Office

1. The total diversion of artesian groundwater from the Culebra Member of the Rustler Formation under this permit will be limited to 1.0 acre-foot per annum measured at the well and a total of 2.0 acre-feet per annum measured at the well during the life of this permit.
2. A totalizing meter of a type approved by and installed in a manner and at a location acceptable to the State Engineer shall be installed before the first branch of the discharge line from the well; the State Engineer shall be advised of the make, model, serial number, date of installation, and initial reading of the meter prior to appropriation of water.
3. The permittee shall record the meter reading in writing on the first day of January, April, July, and October of each year on a form acceptable to the State Engineer and submit said reading to the State Engineer on or before the 10th day of January, April, July, and October of each year.
4. The well shall be constructed to artesian specifications. If any deviation from artesian specifications is required, it must be approved by the State Engineer. The State Engineer, District II Office, Roswell, shall be notified a minimum of 48 hours prior to the casing being landed and/or cemented.
5. The State Engineer shall be advised 48 hours in advance of the beginning of any pumping tests.
6. Well C-2426 shall be drilled by a driller licensed in the State of New Mexico in accordance with 72-12-12 New Mexico Statutes annotated.
7. This permit shall terminate upon the completion of the aquifer testing, or on January 31, 1998, whichever is earlier.

STATE ENGINEER OFFICE
WELL RECORD

Section 1. GENERAL INFORMATION

(A) Owner of well U. S. Dept. of Energy / Carlsbad Area Office Owner's Well No. H-19b1
 Street or Post Office Address P. O. Box 3090
 City and State Carlsbad, NM 88221-3090

Well was drilled under Permit No. C 2420 and is located in the:
 a. SE $\frac{1}{4}$ SE $\frac{1}{4}$ NE $\frac{1}{4}$ SW $\frac{1}{4}$ of Section 28 Township 22S Range 31E N.M.P.M.
 b. Tract No. _____ of Map No. _____ of the _____
 c. Lot No. _____ of Block No. _____ of the _____
 Subdivision, recorded in _____ County.
 d. X= _____ feet, Y= _____ feet, N.M. Coordinate System _____ Zone in
 the _____ Grant.

(B) Drilling Contractor Water Development Corporation License No. WD 1210
 Address 1202 Kentucky Avenue, Woodland Hills, California 95776
 Drilling Began 03/28/95 Completed 04/22/95 Type tools Rotary, Wireline core See Diagram
 Size of hole _____
 Elevation of land surface or Aluminum Cap at well is 3417.2 ft. Total depth of well: 778.7 ft.
 Completed well is shallow artesian. Depth to water upon completion of well ~ 450 ft.

Section 2. PRINCIPAL WATER-BEARING STRATA

Depth in Feet		Thickness in Feet	Description of Water-Bearing Formation	Estimated Yield (gallons per minute)
From	To			
628	652	24	Magenta Dolomite	~ 1/2
740.1	764.4	24.3	Culebra Dolomite	~ 4

Section 3. RECORD OF CASING

Diameter (inches)	Pounds per foot	Threads per in.	Depth in Feet		Length (feet)	Type of Shoe	Perforations	
			Top	Bottom			From	To
20	53	single section	0.3	38	~ 38.3	_____	_____	_____
9-5/8	5.7 fiberglass	4	1.2	731.9	733.1	mixed shoe & float collar	_____	_____

Section 4. RECORD OF MUDDING AND CEMENTING

Depth in Feet		Hole Diameter	Sacks of Mud	Cubic Feet of Cement	Method of Placement
From	To				
0	38	24 in.		~ 50	From top
0	731.9	14.75 in.		~ 794	Halliburton

Section 5. PLUGGING RECORD

Plugging Contractor _____
 Address _____
 Plugging Method _____
 Date Well Plugged _____
 Plugging approved by: _____
 State Engineer Representative

No.	Depth in Feet		Cubic Feet of Cement
	Top	Bottom	
1			
2			
3			
4			

FOR USE OF STATE ENGINEER ONLY

Date Received _____ Quad _____ FWL _____ FSL _____
 File No. _____ Use _____ Location No. _____

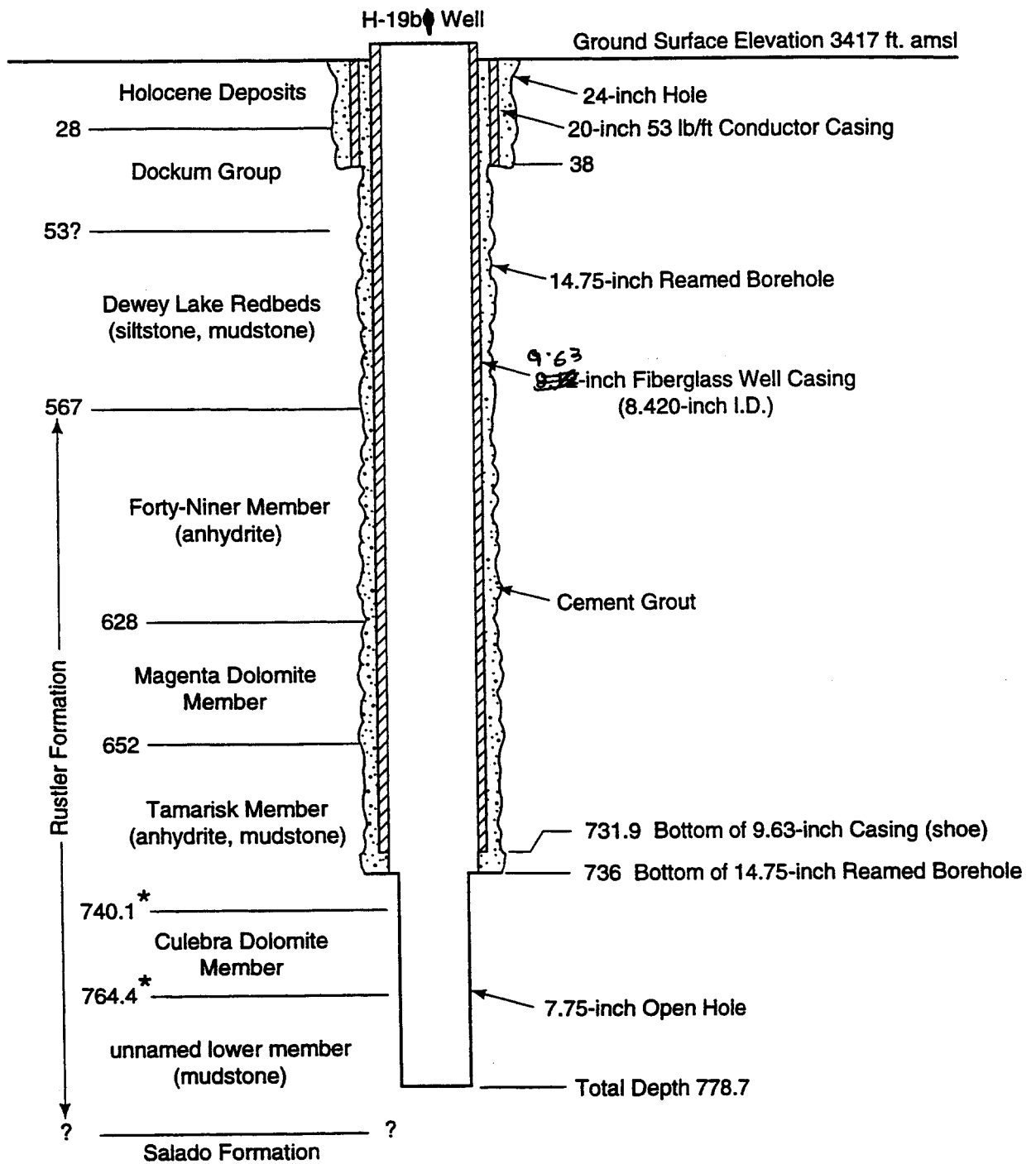

Notes: All formation depths (in feet approximate) from geophysical logs except as noted.

* From core

Not to scale

TRI-6115-206-0

STATE ENGINEER OFFICE
WELL RECORD

Section 1. GENERAL INFORMATION

(A) Owner of well U. S. Department of Energy, Carlsbad Area Office Owner's Well No. H-19b2
Street or Post Office Address P. O. Box 3090
City and State Carlsbad, New Mexico 88221-3090

Well was drilled under Permit No. C 2421 and is located in the:

- a. SE ¼ SE ¼ NE ¼ SW ¼ of Section 28 Township 22S Range 31E N.M.P.M.
- b. Tract No. _____ of Map No. _____ of the _____
- c. Lot No. _____ of Block No. _____ of the _____
Subdivision, recorded in _____ County.
- d. X= _____ feet, Y= _____ feet, N.M. Coordinate System _____ Zone in the _____ Grant.

(B) Drilling Contractor Water Development Corporation License No. WD 1210

Address 1202 Kentucky Avenue, Woodland Hills, California 95776

Drilling Began 05/10/95 Completed 05/20/95 Type tools Rotary, Diamond core See Diagram in.

Elevation of land surface or Aluminum Cap at well is 3417.1 ft. Total depth of well 786 ft.

Completed well is shallow artesian. Depth to water upon completion of well ~ 450 ft.

Section 2. PRINCIPAL WATER-BEARING STRATA

Depth in Feet		Thickness in Feet	Description of Water-Bearing Formation	Estimated Yield (gallons per minute)
From	To			
628	653	25	Magenta Dolomite	~ 1/2
741.6	765	23.4	Culebra Dolomite	~ 4

Section 3. RECORD OF CASING

Diameter (inches)	Pounds per foot	Threads per in.	Depth in Feet		Length (feet)	Type of Shoe	Perforations	
			Top	Bottom			From	To
14	42	single section	0.3	37	~37.3	—	—	—
7	5.7 fiberglass	4	+2	732.4	734.4	mixed shoe & float collar	—	—
5.5	PVC Liner	—	766	780	20	—	—	—

Section 4. RECORD OF MUDDING AND CEMENTING

Depth in Feet		Hole Diameter	Sacks of Mud	Cubic Feet of Cement	Method of Placement
From	To				
0	37	18 in.		~ 35	From top
0	732.4	12.25 in.		~ 606	Halliburton

Section 5. PLUGGING RECORD

Plugging Contractor _____
Address _____
Plugging Method _____
Date Well Plugged _____
Plugging approved by: _____
State Engineer Representative

No.	Depth in Feet		Cubic Feet of Cement
	Top	Bottom	
1			
2			
3			
4			

FOR USE OF STATE ENGINEER ONLY

Date Received _____ Quad _____ FWL _____ FSL _____
File No. _____ Use _____ Location No. _____

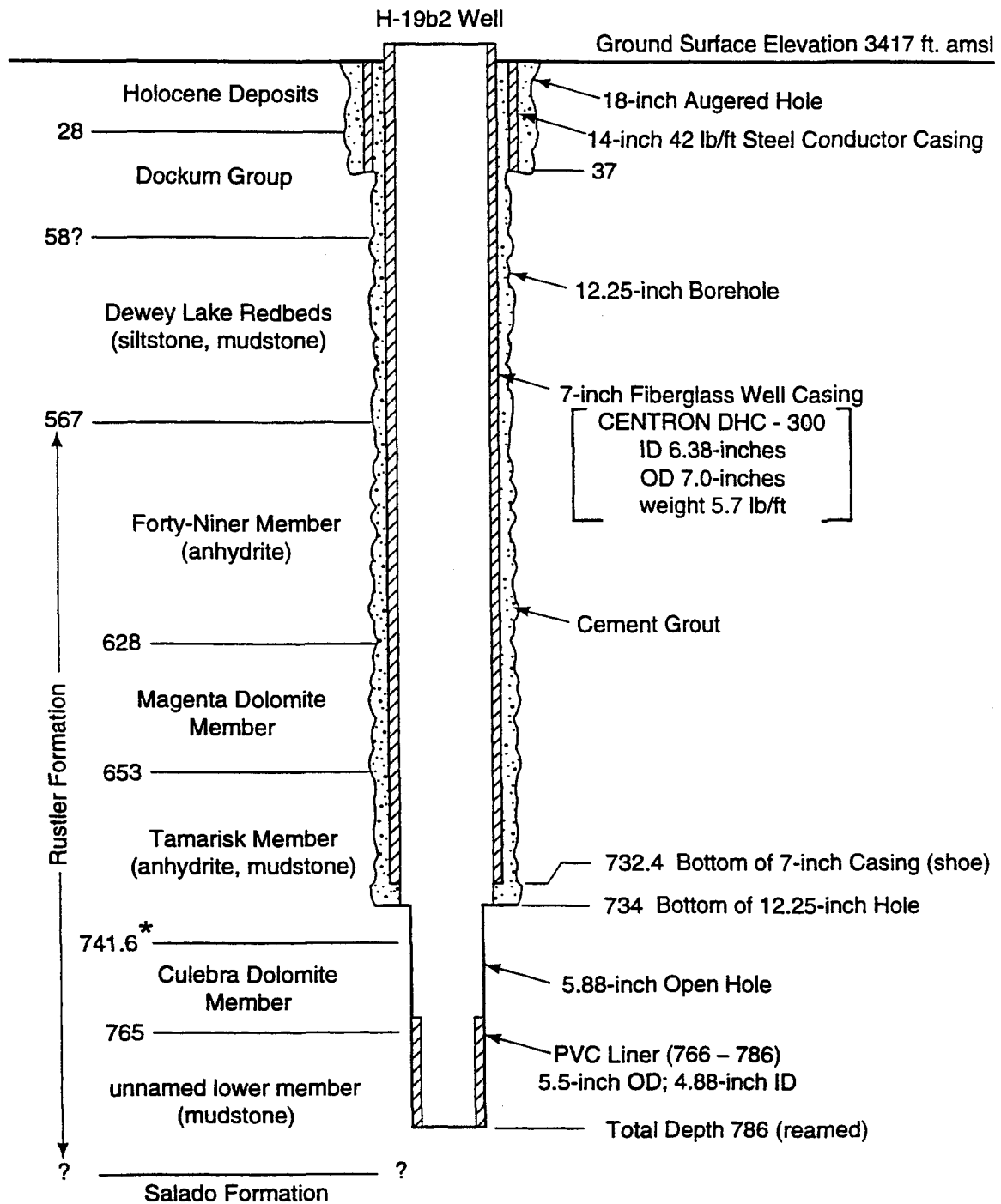

Notes: All formation depths (in feet approximate) from geophysical logs except as noted.

* From core

Not to scale

TRI-6115-207-0

STATE ENGINEER OFFICE
WELL RECORD

Section 1. GENERAL INFORMATION

(A) Owner of well U. S. Department of Energy, Carlsbad Area Office Owner's Well No. H-19b3
Street or Post Office Address P. O. Box 3090
City and State Carlsbad, New Mexico 88221-3090

Well was drilled under Permit No. C 24222 and is located in the:

- a. SE ¼ SE ¼ NE ¼ SW ¼ of Section 28 Township 22S Range 31E N.M.P.M.
- b. Tract No. _____ of Map No. _____ of the _____
- c. Lot No. _____ of Block No. _____ of the _____
Subdivision, recorded in _____ County.
- d. X= _____ feet, Y= _____ feet, N.M. Coordinate System _____ Zone in
the _____ Grant.

(B) Drilling Contractor Water Development Corporation License No. WD 1210

Address 1202 Kentucky Avenue, Woodland Hills, California 95776

Drilling Began 04/23/95 Completed 05/09/95 Type tools Rotary & Wireline core See Diagram in.

Elevation of land surface or Aluminum Cap at well is 3417.2 ft. Total depth of well 785 ft.

Completed well is shallow artesian. Depth to water upon completion of well ~ 450 ft.

Section 2. PRINCIPAL WATER-BEARING STRATA

Depth in Feet		Thickness in Feet	Description of Water-Bearing Formation	Estimated Yield (gallons per minute)
From	To			
629	654	25	Magenta Dolomite	~ 1/2
740.0	765	25	Culebra Dolomite	~ 4

Section 3. RECORD OF CASING

Diameter (inches)	Pounds per foot	Threads per in.	Depth in Feet		Length (feet)	Type of Shoe	Perforations	
			Top	Bottom			From	To
14	42	single section	+0.3	38	~ 38.3	—	—	—
7	5.7 fiberglass	4	1.7	732	733.7	mixed shoe & float collar	—	—
5.5	PVC liner	—	762	782	20	—	—	—

Section 4. RECORD OF MUDDING AND CEMENTING

Depth in Feet		Hole Diameter	Sacks of Mud	Cubic Feet of Cement	Method of Placement
From	To				
0	38	18" in.		~ 35	From top
0	734	12.25 in.		~ 606	Halliburton

Section 5. PLUGGING RECORD

Plugging Contractor _____
Address _____
Plugging Method _____
Date Well Plugged _____
Plugging approved by: _____

No.	Depth in Feet		Cubic Feet of Cement
	Top	Bottom	
1			
2			
3			
4			

State Engineer Representative

FOR USE OF STATE ENGINEER ONLY

Date Received _____ Quad _____ FWL _____ FSL _____

File No. _____ Use _____ Location No. _____

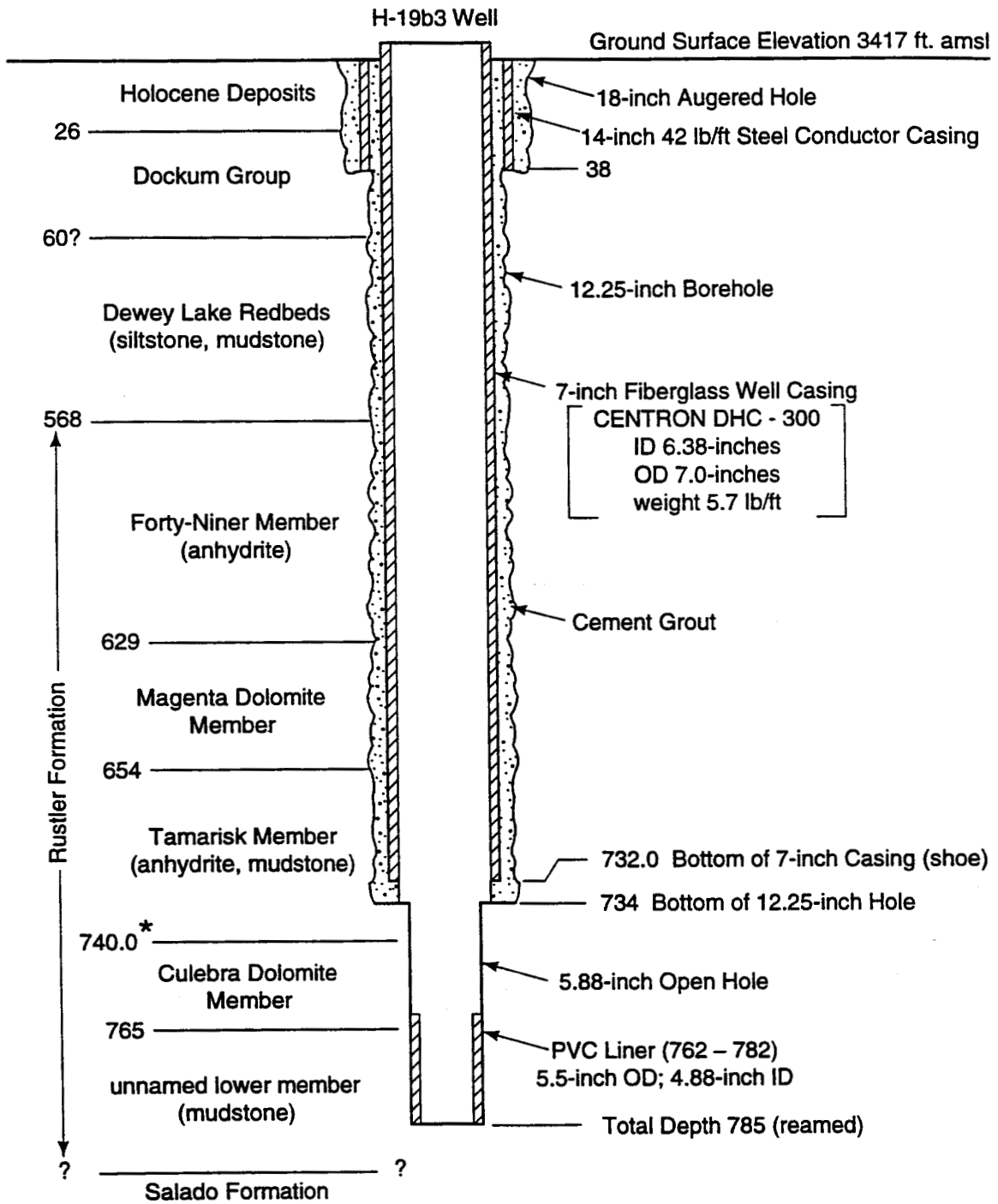

Notes: All formation depths (in feet approximate) from geophysical logs except as noted.

* From core

Not to scale

TRI-8115-208-0

STATE ENGINEER OFFICE
WELL RECORD

Section 1. GENERAL INFORMATION

(A) Owner of well U. S. Department of Energy, Carlsbad Area Office Owner's Well No. H-19b4
Street or Post Office Address P. O. Box 3090
City and State Carlsbad, New Mexico 88221-3090

Well was drilled under Permit No. C 2423 and is located in the:

- a. SE ¼ SE ¼ NE ¼ SW ¼ of Section 28 Township 22S Range 31E N.M.P.M.
- b. Tract No. _____ of Map No. _____ of the _____
- c. Lot No. _____ of Block No. _____ of the _____
Subdivision, recorded in _____ County.
- d. X= _____ feet, Y= _____ feet, N.M. Coordinate System _____ Zone in
the _____ Grant.

(B) Drilling Contractor Water Development Corporation License No. WD 1210

Address 1202 Kentucky Avenue, Woodland Hills, California 95776

Drilling Began 05/26/95 Completed 06/05/95 Type tools Rotary Size of hole Diagram in. See

Elevation of land surface or Aluminum Cap at well is 3416 ft. Total depth of well: 782 ft.

Completed well is shallow artesian. Depth to water upon completion of well ~ 450 ft.

Section 2. PRINCIPAL WATER-BEARING STRATA

Depth in Feet		Thickness in Feet	Description of Water-Bearing Formation	Estimated Yield (gallons per minute)
From	To			
628	653	25	Magenta Dolomite	~ 1/2
738.5	761.8	23.3	Culebra Dolomite	~ 4

Section 3. RECORD OF CASING

Diameter (inches)	Pounds per foot	Threads per in.	Depth in Feet		Length (feet)	Type of Shoe	Perforations	
			Top	Bottom			From	To
14	42	single section	0	38	38	_____	_____	_____
7	5.7 fiberglass	4	+2.6	730.7	733.3	mixed shoe & float collar	_____	_____
5.5	PVC liner	_____	762	782	20	_____	_____	_____

Section 4. RECORD OF MUDDING AND CEMENTING

Depth in Feet		Hole Diameter	Sacks of Mud	Cubic Feet of Cement	Method of Placement
From	To				
0	38	18 in.		~ 35	From top
0	736.7	12.25 in.		~ 606	Balliburton

Section 5. PLUGGING RECORD

Plugging Contractor _____
Address _____
Plugging Method _____
Date Well Plugged _____
Plugging approved by: _____
State Engineer Representative

No.	Depth in Feet		Cubic Feet of Cement
	Top	Bottom	
1			
2			
3			
4			

FOR USE OF STATE ENGINEER ONLY

Date Received _____ Quad _____ FWL _____ FSL _____
File No. _____ Use _____ Location No. _____

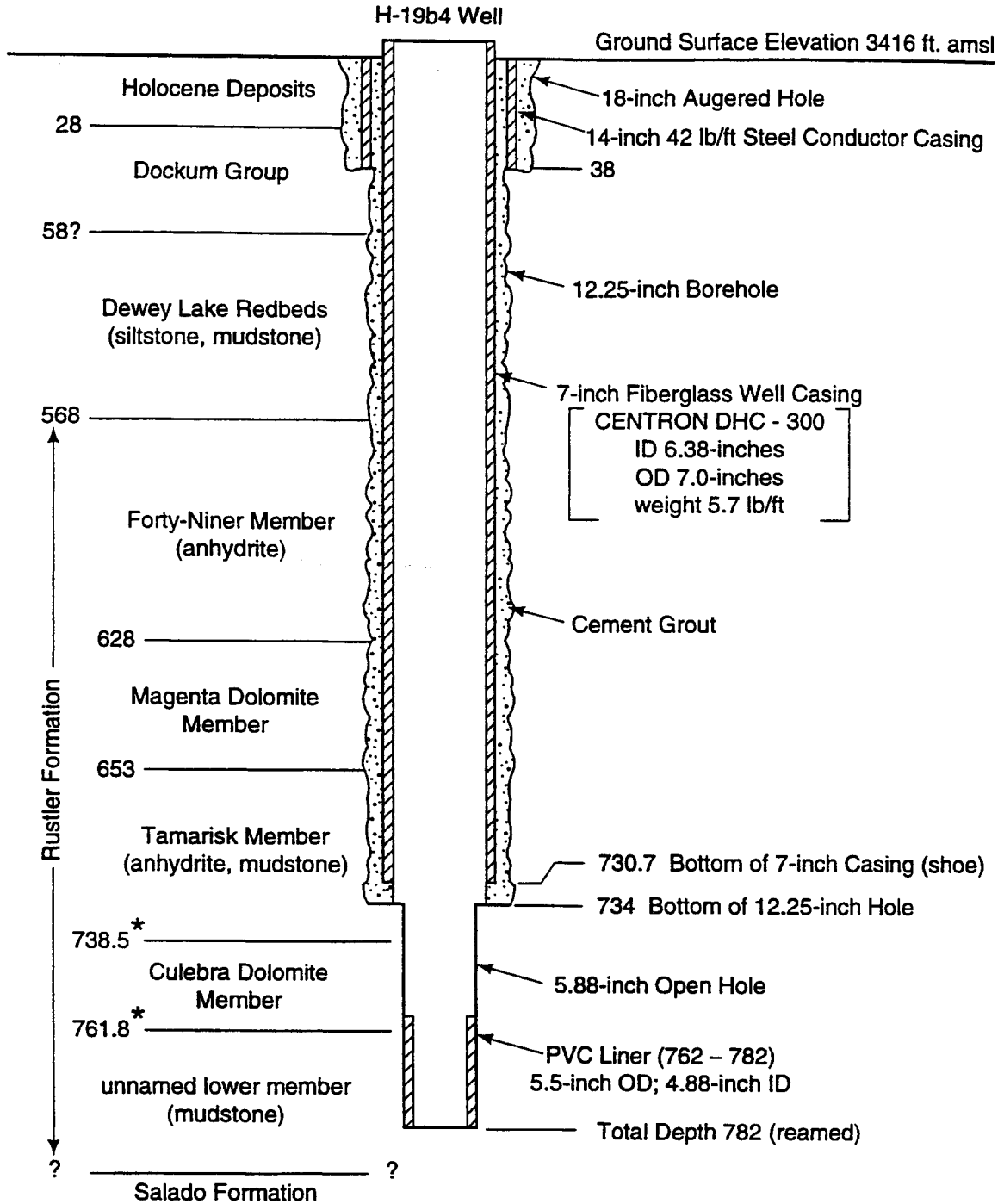

Notes: All formation depths (in feet approximate) from geophysical logs except as noted.

* From core

Not to scale

TRI-8115-209-0

STATE ENGINEER OFFICE
WELL RECORD

Section 1. GENERAL INFORMATION

(A) Owner of well U.S. Department of Energy, Carlsbad Area Office Owner's Well No. H-19b5
Street or Post Office Address P. O. Box 3090
City and State Carlsbad, NM 88221-3090

Well was drilled under Permit No. C 2424 and is located in the:

- a. SE $\frac{1}{4}$ SE $\frac{1}{4}$ NE $\frac{1}{4}$ SW $\frac{1}{4}$ of Section 28 Township 22S Range 31E N.M.P.M.
b. Tract No. _____ of Map No. _____ of the _____
c. Lot No. _____ of Block No. _____ of the _____
Subdivision, recorded in _____ County.
d. X= _____ feet, Y= _____ feet, N.M. Coordinate System _____ Zone in
the _____ Grant.

(B) Drilling Contractor Water Development Corporation License No. WD 1210
Address 1202 Kentucky Avenue, Woodland Hills, California 95776
Drilling Began 06/11/95 Completed 08/27/95 Type tools Rotary, Diamond Core See Diagram in.
Elevation of land surface or Aluminum Cap at well is 3417.1 ft. Total depth of well 785.5 ft.
Completed well is shallow artesian. Depth to water upon completion of well ~ 450 ft.

Section 2. PRINCIPAL WATER-BEARING STRATA

Depth in Feet		Thickness in Feet	Description of Water-Bearing Formation	Estimated Yield (gallons per minute)
From	To			
623	649	26	Magenta Dolomite	~ 1/2
736.7	761.2	24.5	Culebra Dolomite	~ 4

Section 3. RECORD OF CASING

Diameter (inches)	Pounds per foot	Threads per in.	Depth in Feet		Length (feet)	Type of Shoe	Perforations	
			Top	Bottom			From	To
14	42	single section	+ 0.3	38	~ 38.3			
7	5.7 fiberglass	4	+ 1.6	730.7	~ 732.3	mixed shoe & float collar		
5.5	PVC liner		763	783	20			

Section 4. RECORD OF MUDDING AND CEMENTING

Depth in Feet		Hole Diameter	Sacks of Mud	Cubic Feet of Cement	Method of Placement
From	To				
0	38	18 in.		~ 35	From top
0	734	12.25 in.		~ 606	Halliburton

Section 5. PLUGGING RECORD

Plugging Contractor _____
Address _____
Plugging Method _____
Date Well Plugged _____
Plugging approved by: _____
State Engineer Representative

No.	Depth in Feet		Cubic Feet of Cement
	Top	Bottom	
1			
2			
3			
4			

FOR USE OF STATE ENGINEER ONLY

Date Received _____ Quad _____ FWL _____ FSL _____
File No. _____ Use _____ Location No. _____

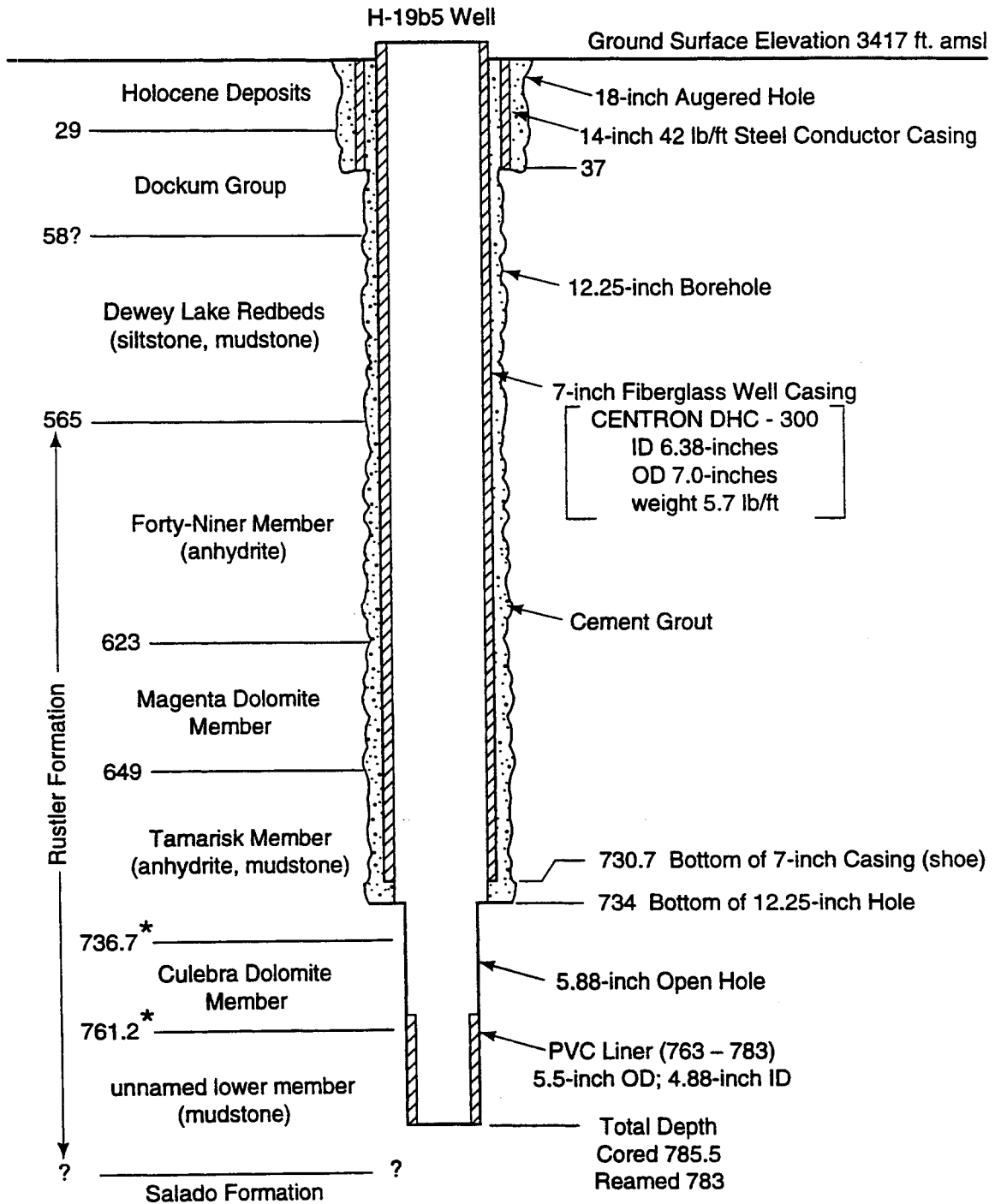

Notes: All formation depths (in feet approximate) from geophysical logs except as noted.

* From core

Not to scale

TRI-8115-210-0

STATE ENGINEER OFFICE
WELL RECORD

Section 1. GENERAL INFORMATION

(A) Owner of well U.S. Department of Energy, Carlsbad Area Office Owner's Well No. H-19b6
Street or Post Office Address P. O. Box 3090
City and State Carlsbad, NM 88221-3090

Well was drilled under Permit No. C 2425 and is located in the:

- a. SE $\frac{1}{4}$ SE $\frac{1}{4}$ NE $\frac{1}{4}$ SW $\frac{1}{4}$ of Section 28 Township 22S Range 31E N.M.P.M.
b. Tract No. _____ of Map No. _____ of the _____
c. Lot No. _____ of Block No. _____ of the _____
Subdivision, recorded in _____ County.
d. X= _____ feet, Y= _____ feet, N.M. Coordinate System _____ Zone in
the _____ Grant.

(B) Drilling Contractor Water Development Corporation License No. WD 1210

Address 1202 Kentucky Avenue, Woodland Hills, California 95776

Drilling Began 07/10/95 Completed 08/25/95 Type tools Rotary, Diamond core See diagram in.

Elevation of land surface or Aluminum Cap at well is 3417.2 ft. Total depth of well 788.1 ft.

Completed well is shallow artesian. Depth to water upon completion of well ~ 450 ft.

Section 2. PRINCIPAL WATER-BEARING STRATA

Depth in Feet		Thickness in Feet	Description of Water-Bearing Formation	Estimated Yield (gallons per minute)
From	To			
623	649	26	Magenta Dolomite	~ 1/2
739.0	765	26	Culebra Dolomite	~ 4

Section 3. RECORD OF CASING

Diameter (inches)	Pounds per foot	Threads per in.	Depth in Feet		Length (feet)	Type of Shoe	Perforations	
			Top	Bottom			From	To
14	42	single section	+ 0.3	39	~ 39.3	—	—	—
7	5.7 fiberglass	4	+ 1.9	730.1	~ 732	mixed shoe & float collar	—	—
5.5	PVC liner	—	766	786	20	—	—	—

Section 4. RECORD OF MUDDING AND CEMENTING

Depth in Feet		Hole Diameter	Sacks of Mud	Cubic Feet of Cement	Method of Placement
From	To				
0	39	18 in.		~ 35	From top
0	733	12.25 in.		~ 606	Halliburton, Tremie Pipe

Section 5. PLUGGING RECORD

Plugging Contractor _____
Address _____
Plugging Method _____
Date Well Plugged _____
Plugging approved by: _____
State Engineer Representative

No.	Depth in Feet		Cubic Feet of Cement
	Top	Bottom	
1			
2			
3			
4			

FOR USE OF STATE ENGINEER ONLY

Date Received _____ Quad _____ FWL _____ FSL _____

File No. _____ Use _____ Location No. _____

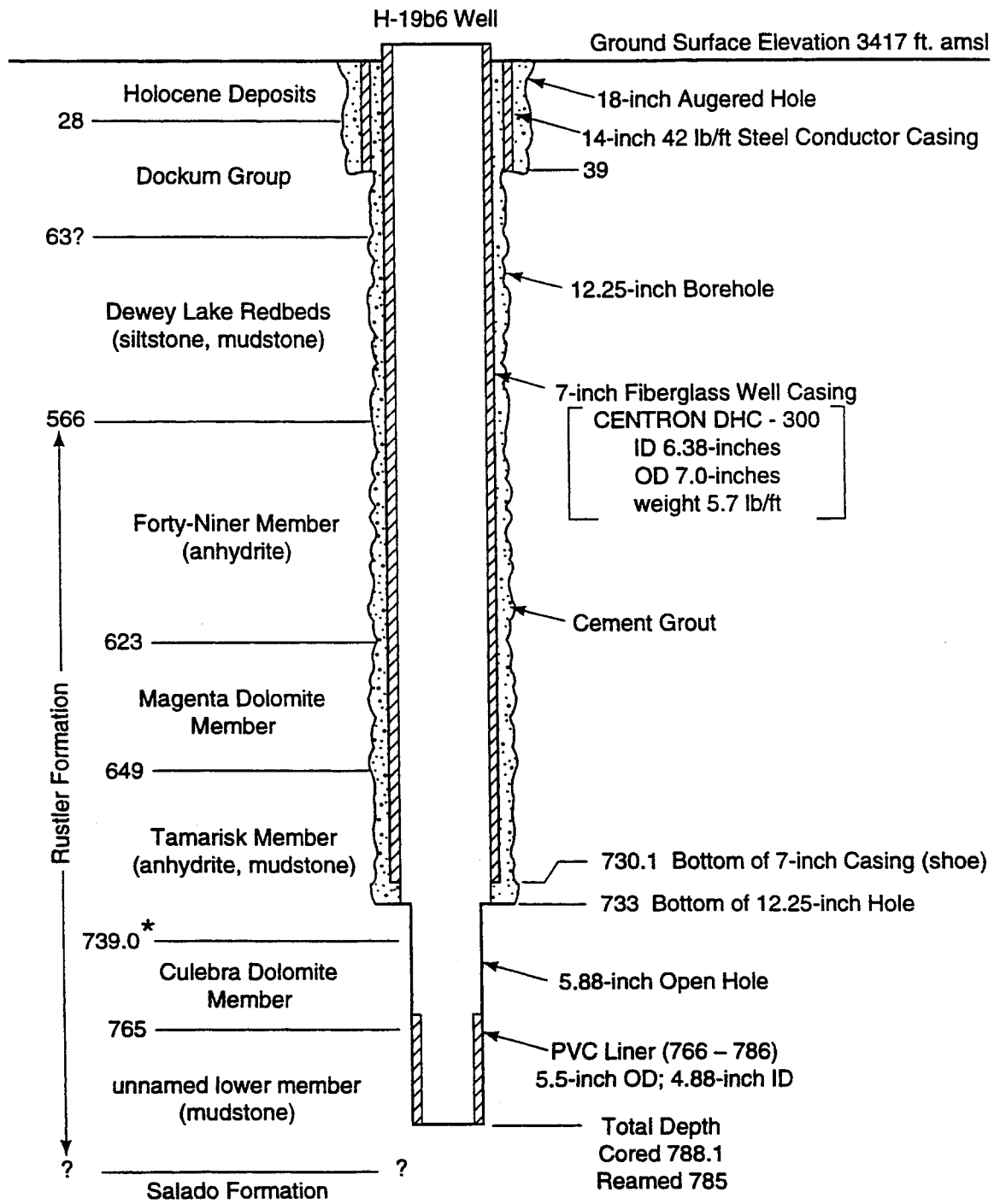

Notes: All formation depths (in feet approximate) from geophysical logs except as noted.

* From core

Not to scale

TRI-6115-211-0

STATE ENGINEER OFFICE
WELL RECORD

Section 1. GENERAL INFORMATION

(A) Owner of well U.S. Department of Energy, Carlsbad Area Office Owner's Well No. H-19b7
Street or Post Office Address P. O. Box 3090
City and State Carlsbad, NM 88221-3090

Well was drilled under Permit No. C 2426 and is located in the:
a. SE $\frac{1}{4}$ SE $\frac{1}{4}$ NE $\frac{1}{4}$ SW $\frac{1}{4}$ of Section 28 Township 22S Range 31E N.M.P.M.
b. Tract No. _____ of Map No. _____ of the _____
c. Lot No. _____ of Block No. _____ of the _____
Subdivision, recorded in _____ County.
d. X= _____ feet, Y= _____ feet, N.M. Coordinate System _____ Zone in
the _____ Grant.

(B) Drilling Contractor Water Development Corporation License No. WD 1210
Address 1202 Kentucky Avenue, Woodland Hills, California 95776
Type tools Rotary See Diamond Core Size of hole Diagram
Drilling Began 07/26/95 Completed 08/20/95
Elevation of land surface or Aluminum Cap at well is 3417.2 ft. Total depth of well 785 ft.
Completed well is shallow artesian. Depth to water upon completion of well ~ 450 ft.

Section 2. PRINCIPAL WATER-BEARING STRATA

Depth in Feet		Thickness in Feet	Description of Water-Bearing Formation	Estimated Yield (gallons per minute)
From	To			
627	652	25	Magenta Dolomite	~ 1/2
739.5	764	24.5	Culebra Dolomite	~ 4

Section 3. RECORD OF CASING

Diameter (inches)	Pounds per foot	Threads per in.	Depth in Feet		Length (feet)	Type of Shoe	Perforations	
			Top	Bottom			From	To
14	42	single section	+ .1	38	~38.1	—	—	—
7	5.7	4	+ .8	731.0	~731.8	mixed shoe & float collar	—	—
5.5	PVC liner	—	764	784	20	—	—	—

Section 4. RECORD OF MUDDING AND CEMENTING

Depth in Feet		Hole Diameter	Sacks of Mud	Cubic Feet of Cement	Method of Placement
From	To				
0	38	18 in.		~ 35	From top
0	734	12.25 in.		~ 606	Halliburton

Section 5. PLUGGING RECORD

Plugging Contractor _____	<table border="1"> <thead> <tr> <th rowspan="2">No.</th> <th colspan="2">Depth in Feet</th> <th rowspan="2">Cubic Feet of Cement</th> </tr> <tr> <th>Top</th> <th>Bottom</th> </tr> </thead> <tbody> <tr> <td>1</td> <td></td> <td></td> <td></td> </tr> <tr> <td>2</td> <td></td> <td></td> <td></td> </tr> <tr> <td>3</td> <td></td> <td></td> <td></td> </tr> <tr> <td>4</td> <td></td> <td></td> <td></td> </tr> </tbody> </table>	No.	Depth in Feet		Cubic Feet of Cement	Top	Bottom	1				2				3				4			
No.			Depth in Feet			Cubic Feet of Cement																	
		Top	Bottom																				
1																							
2																							
3																							
4																							
Address _____																							
Plugging Method _____																							
Date Well Plugged _____																							
Plugging approved by: _____	State Engineer Representative																						

FOR USE OF STATE ENGINEER ONLY

Date Received _____ Quad _____ FWL _____ FSL _____

File No. _____ Use _____ Location No. _____

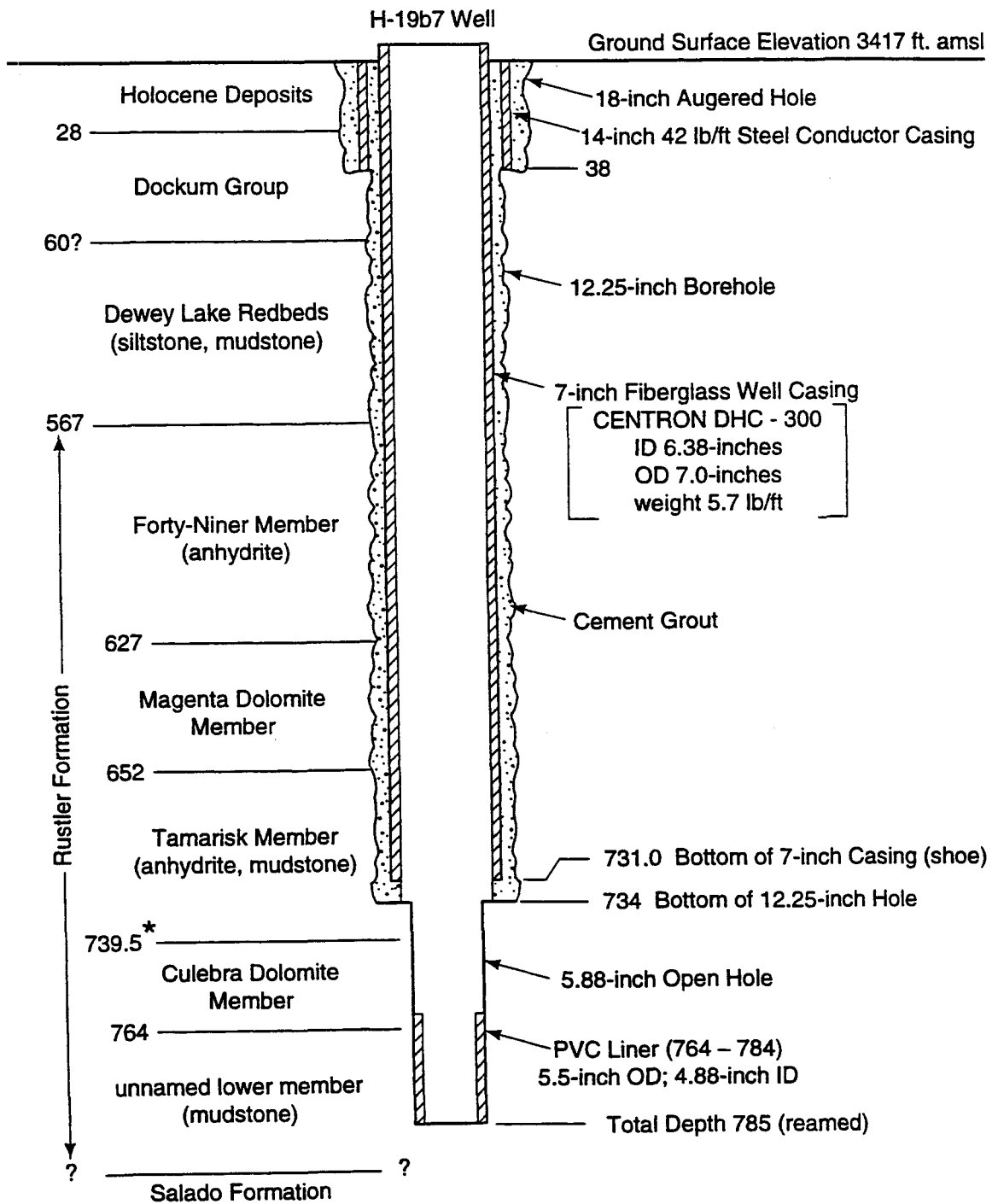

Notes: All formation depths (in feet approximate) from geophysical logs except as noted.

* From core

Not to scale

TRI-6115-212-0

Page intentionally left blank.



THE WESTERN COMPANY
CEMENT JOB DETAIL SHEET

CUSTOMER <i>WINDIT out well 115</i>	DATE <i>4/30/88</i>	F.R.# <i>1090483</i>	SER. SUP. <i>1000000</i>	TYPE JOB <i>Drilling</i>
LEASE & WELL NAME-OCSG <i>WINDIT out well 115</i>	LOCATION <i>H-19 B3</i>	COUNTY-PARISH-BLOCK <i>Cady</i>		
DISTRICT <i>W-1</i>	DRILLING CONTRACTOR RIG #	OPERATOR		

MATERIAL FURNISHED BY WPS	TYPE OF PLUGS	LIST-CSG-HARDWARE	SQ MANI FOLD Y N	TOP OF EACH FLUID	PHYSICAL SLURRY PROPERTIES						
					SLURRY WGT PPG	SLURRY YLD FT	WATER GFS	PUMP TIME HR:MIN	Bbl SLURRY	Bbl MIX WATER	
<i>250 PSL C 2% Attaching 5% salt</i>					<i>12.4</i>	<i>1.99</i>	<i>10.74</i>		<i>88.6</i>	<i>65</i>	
<i>1/4" x 1/2" 1000 Gal</i>											
<i>100 slt C 2% salt</i>					<i>14.8</i>	<i>1.54</i>	<i>4.32</i>		<i>251</i>	<i>15</i>	
Available Mix Water <i>130</i> Bbl.					Available Displ. Fluid <i>130</i> Bbl.					TOTAL	<i>1124.50</i>

HOLE			TBG-CSG-D.P.				TBG-CSG-D.P.				COLLAR DEPTHS		
SIZE	% EXCESS	DEPTH	SIZE	WGT.	TYPE	DEPTH	SIZE	WGT.	TYPE	DEPTH	SHOE	FLOAT	STAGE
<i>12 1/4</i>	<i>2.0</i>	<i>735</i>	<i>7"</i>	<i>7</i>	<i>5.4</i>	<i>740</i>					<i>2</i>		
LAST CASING			PKR-CMT RET-BR PL-LINER			PERF. DEPTH		TOP CONN		WELL FLUID			
SIZE	WGT	TYPE	DEPTH	BRAND & TYPE		DEPTH	TOP	BTM	SIZE	THREAD	TYPE	WGT.	
CAL. DISPL. VOL.-Bbl.				CAL. PSI	CAL. MAX PSI	OP. MAX	MAX TBG PSI		MAX CSG PSI		DISPL. FLUID		WATER SOURCE
TBG	CSG	CSG	TOTAL	BUMP PLUG	TO REV	SO. PSI	RATED	OP.	RATED	OP.	TYPE	WGT.	
			<i>29</i>		<i>100</i>		<i>1500</i>				<i>10.0</i>	<i>1000</i>	<i>77100</i>

EXPLANATION: TROUBLE SETTING TOOL RUNNING CSG, ETC. PRIOR TO CEMENTING.

PRESSURE/RATE DETAIL						EXPLANATION	
TIME HR: MIN.	PRESSURE-PSI		RATE BPM	Bbl. FLUID PUMPED	FLUID TYPE	SAFETY MEETING: WPS CREW <input type="checkbox"/> CO. REP <input type="checkbox"/>	
	PIPE	ANNULUS				TEST LINES PSI	
<i>1400</i>						<input type="checkbox"/> CIRCULATING WELL-RIG <input type="checkbox"/> WPS <input type="checkbox"/>	
<i>1515</i>	<i>100</i>		<i>2.0</i>	<i>10.0</i>	<i>3.7</i>	<i>200 location / 1st Rev Meeting</i>	
<i>1518</i>	<i>150</i>		<i>4.0</i>	<i>88.6</i>	<i>17.4</i>	<i>Wm u-1</i>	
<i>1537</i>	<i>250</i>		<i>4.5</i>	<i>27.6</i>	<i>34.8</i>	<i>L. cut</i>	
<i>1545</i>	<i>250.0</i>					<i>T. cut</i>	
<i>1548</i>	<i>2250</i>		<i>4.5</i>	<i>94</i>	<i>10.0</i>	<i>shut down release plug</i>	
<i>1554</i>	<i>250</i>					<i>Discharge with 10 min</i>	
						<i>shut down release plug</i>	

BUMPED PLUG	PSI TO BUMP PLUG	TEST FLOAT EQUIP.	TOTAL Bbl. PUMPED	Bbl. CMT RETURNS/ REVERSED	PSI LEFT ON CSG	SPOT TOP CEMENT	SER. SUP. <i>1000000</i>
<i>Y (N)</i>	<i>250</i>	<i>(Y) N</i>	<i>121.4</i>	<i>34.0</i>			<i>1000000</i>
							CUSTOMER REP <i>W. W. W.</i>



CEMENT JOB DETAIL SHEET

CUSTOMER <i>Spartan National Lab</i>	DATE <i>6-29-88</i>	F.R.# <i>290537</i>	SER. SUP. <i>Bill Thurmon</i>	TYPE JOB <i>Salt L.C.</i>
LEASE & WELL NAME OCSG <i>H-19 B5</i>		LOCATION		COUNTY-PARISH-BLOCK <i>Eddo</i>

DISTRICT <i>Artesia</i>	DRILLING CONTRACTOR RIG #	OPERATOR <i>Same</i>
----------------------------	---------------------------	-------------------------

MATERIAL FURNISHED BY WPS	TYPE OF PLUGS	LIST-CSG-HARDWARE	SO MANI FOLD Y N	TOP OF EACH FLUID	PHYSICAL SLURRY PROPERTIES						
					SLURRY WGT PPG	SLURRY YLD FT	WATER GPS	PUMP TIME HR:MIN	Bbl SLURRY	Bbl MIX WATER	
	<i>TOP</i> BTM	<i>7" Rubber</i>									
<i>250.5x PSLCW</i>		<i>2 1/2" ATTACH, 5% Salt, 1/4" Seal</i>			<i>12.4</i>	<i>1.99</i>	<i>10.96</i>			<i>88.6</i>	<i>65.7</i>
<i>100.5x</i>		<i>1 + 2% NaCl</i>			<i>14.9</i>	<i>1.30</i>	<i>1.37</i>			<i>25.5</i>	<i>15</i>

Available Mix Water <i>140</i> Bbl.	Available Displ. Fluid <i>140</i> Bbl.	TOTAL <i>1121</i> <i>80.2</i>
-------------------------------------	--	-------------------------------

HOLE			TBG-CSG-D.P.				TBG-CSG-D.P.				COLLAR DEPTHS		
SIZE	% EXCESS	DEPTH	SIZE	WGT.	TYPE	DEPTH	SIZE	WGT.	TYPE	DEPTH	SHOE	FLOAT	STAGE
<i>12 1/2</i>	<i>~</i>	<i>732</i>	<i>7</i>	<i>5.75</i>	<i>Fiber Glass</i>	<i>732</i>					<i>732</i>		

LAST CASING		PKR-CMT RET-BR PL-LINER		PERF. DEPTH		TOP CONN		WELL FLUID			
SIZE	WGT	TYPE	DEPTH	BRAND & TYPE	DEPTH	TOP	BTM	SIZE	THREAD	TYPE	WGT.
								<i>7"</i>	<i>8 thread</i>	<i>fluid</i>	<i>9+</i>

CAL. DISPL. VOL.-Bbl.				CAL. PSI		CAL. MAX PS		OP. MAX		MAX TBG PSI		MAX CSG PSI		DISPL. FLUID		WATER SOURCE
TBG.	CSG.	CSG.	TOTAL	BUMP PLUG	TO REV	SO. PSI	RATED	OP.	RATED	OP.	RATED	OP.	TYPE	WGT.		
			<i>29</i>	<i>29</i>	<i>190</i>						<i>600</i>	<i>500</i>	<i>H2O</i>	<i>9.5</i>	<i>Dig</i>	

EXPLANATION: TROUBLE SETTING TOOL RUNNING CSG. ETC. PRIOR TO CEMENTING.

PRESSURE/RATE DETAIL						EXPLANATION	
TIME HR: MIN.	PRESSURE-PSI		RATE BPM	Bbl. FLUID PUMPED	FLUID TYPE	SAFETY MEETING: WPS CREW <input checked="" type="checkbox"/> CO. REP <input type="checkbox"/>	
	PIPE	ANNULUS				TEST LINES	PSI
<i>6:38</i>	<i>150</i>		<i>2</i>	<i>4</i>	<i>Brine</i>	CIRCULATING WELL-RIG <input type="checkbox"/> WPS <input checked="" type="checkbox"/>	
<i>6:41</i>	<i>250</i>		<i>4</i>		<i>H2O</i>	<i>H2O ahead</i>	
<i>6:43</i>	<i>250</i>		<i>4</i>	<i>8</i>	<i>H2O</i>	<i>Start lead cement @ 12.4"/100'</i>	
<i>7:02</i>	<i>250</i>		<i>4</i>	<i>88</i>	<i>cut</i>	<i>Start tail cement @ 11.8"/100'</i>	
<i>7:08</i>				<i>235</i>	<i>cut</i>	<i>Shutdown 110g plug</i>	
<i>7:09</i>	<i>200</i>		<i>4</i>		<i>Brine</i>	<i>Last displacement</i>	
<i>7:17</i>	<i>500</i>			<i>29</i>	<i>"</i>	<i>Bump plug</i>	
						<i>54.5x circulated to pit</i>	

BUMPED PLUG	PSI TO BUMP PLUG	TEST FLOAT EQUIP.	TOTAL Bbl. PUMPED	Bbl. CMT RETURNS REVERSED	PSI LEFT ON CSG	SPOT TOP CEMENT	SER. SUP. <i>Bill Thurmon</i>
<i>(Y) N</i>	<i>500</i>	<i>(Y) N</i>	<i>29</i>	<i>19</i>	<i>0</i>	<i>Same</i>	CUSTOMER REP. <i>Jerry Mercer</i>

Page intentionally left blank.

APPENDIX E

Archeological Clearance Report

Page intentionally left blank.

PECOS
ARCHEOLOGICAL
CONSULTANTS
P.O. BOX 1771
CARLSBAD, NM 88221

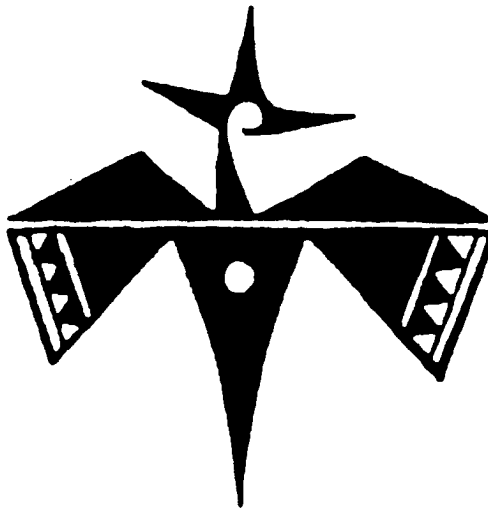

Archeological Clearance Report for
Sandia, Inc.'s
W.I.P.P H-19 Drill Location
Situated on Department of Energy Lands in Eddy County, N.M.
PAC Report No. 94115

Archeological Clearance Report for
Sandia, Inc.'s
W.I.P.P H-19 Drill Location
Situated on Department of Energy Lands in Eddy County, N.M.
PAC Report No. 94115

prepared by
Robert J. Martin

submitted by
Pecos Archeological Consultants
P.O. Box 1771, Carlsbad, N.M., 88221
26 July, 1994
BLM Cultural Use Permit No. 6-2920-92-M
State Blanket Survey Permit No. 94-024

ABSTRACT

On 20 Jul., 1994, Pecos Archeological Consultants undertook an archeological inventory of a drill location scheduled to be impacted by Sandia Labs, Inc. The project will be situated on public lands in Eddy County, New Mexico. These lands occur in section 28, T22S, R31E Eddy Co., N.M. 11.25 acres of D.O.E. lands were accomplished in 4 man-hours, including report preparation, by Robert J. Martin. No cultural remains were recorded as a result of field activities. Pecos Archeological Consultants are recommending clearance for this project, as it is planned.

INTRODUCTION

On 17 July, 1994, Pecos Archeological Consultants was requested by Mr. Wayne Stensrud, representing Sandia Labs, Inc., to perform the archeological survey for a drill location scheduled to be constructed in Eddy County, New Mexico. This land is administered by the Department of Energy and it will be impacted by construction of the location pad. Consequently, federal law requires that an intensive archeological inventory be performed to identify what cultural resources might be impacted by such construction prior to granting clearance to the project. Therefore, Pecos Archeological Consultants undertook this survey on 20 July, 1994. Fieldwork for this project was performed by Robert J Martin. The following is a report of the field activities and findings resulting from the survey:

SURVEY METHODOLOGY

Pecos Archeological Consultants conducted the survey by physically examining the entire impact zone. Pedestrian inspection along parallel transects was accomplished for the 700 X 700 ft. well pad. These transects were spaced 15 meters apart; however, established transects were departed from to examine nearby areas of high site probability. All prominent deflations and denuded areas were given special attention. Surface visibility in the region, which, due to floral cover, ranged between 25-55% of the ground under dry soil conditions, made this the most practical methodology for effectively sampling the impact zone which will result from this project as planned.

LOCATIONAL DATA

Sandia's drill location, designated as H-19, will measure 700 X 700 ft, or an area of 11.25 acres. The well will be situated 1473.1 ft from the South Line and 2459.22 from the from the West Line, or in the:

NW1/4 SE1/4, section 28, T22S, R31E, NMPM, Eddy Co., N.M.

SW1/4 SE1/4, section 28, T22S, R31E, NMPM, Eddy Co., N.M.

SE1/4 SW1/4, section 28, T22S, R31E, NMPM, Eddy Co., N.M.

NE1/4 SW1/4, section 28, T22S, R31E, NMPM, Eddy Co., N.M.

Map Reference: USGS Los Medanos Quadrangle, 7.5 Minute Series, 1985.

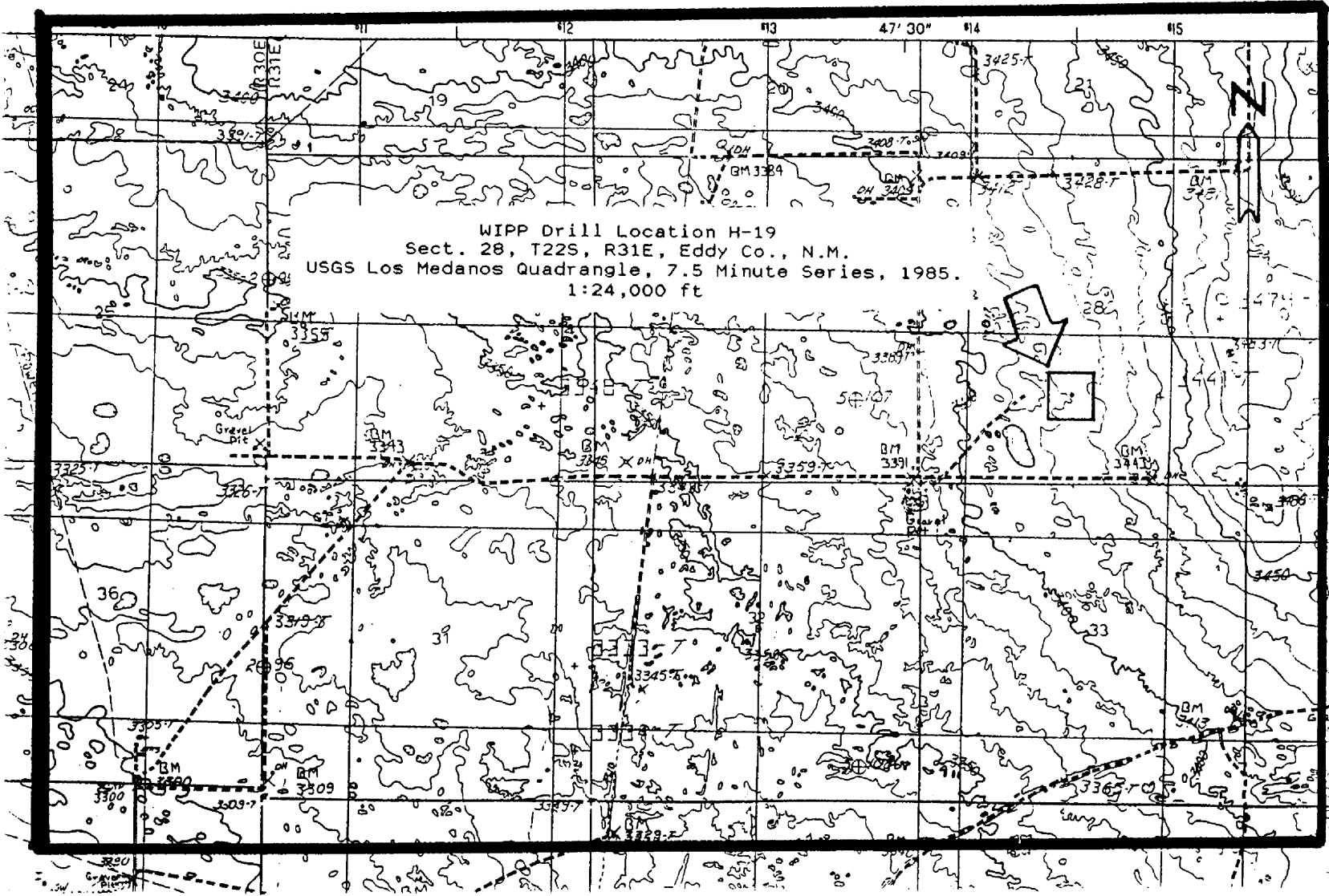

ENVIRONMENT

his project will be will be situated on the undulating to rolling plain in the vicinity of the Los Medanos region of southeast New Mexico. Character for the topography is provided in the form of stabilized sand dunes and duned ridges (microrelief, 0.10m-3.5m) and their attendant deflation basins. Local soils in the region consist loamy sands of the Pyote-Maljamar-Kermit or Kermit -Berino soil associations, or deep sands over ndurated caliche or bed caliche. These soils are drained by primarily internal means, except for rills and arroyos, which in some areas are subject to sheetwash. Occasional cherty inclusions can be seen; these result from the weathering of the Mescalero pediment and were deposited from the Ogallalan formation. Some of the lithic material is suitable for chipped stone tool manufacture. Santa Rosa Formation sandstone is occasionally visible in the deeper arroyo cuts away from the project area, and the material was an aboriginal raw material source for grinding tools. Elevation in the project area is approximately 3410 ft ft above sea level.

The plant community in the project area includes shin oak (Quercus havardii), (mesquite (Prosopis juliflora), broom snakeweed (Gutierrezia sarothrae), and various grasses. Some of the common faunal types in area are mule deer (Odocoileus hemionus), pronghorn antelope (Antilocapra americana), jackrabbit (Lepus sp.), cottontail rabbit (Silvilagus sp.), coyote (Canis latrans), as well as other small mammals, birds and reptiles.

ARCHEOLOGICAL RESOURCES

scos Archeological Consultants performed a literature search to determine if any archeological sites had already been recorded in the vicinity of the project area. Current BLM files and the National Register of Historic Places were consulted in this endeavor. It was determined that no previously-recorded sites are within a reasonable distance of the project area.

Observed Archeological Manifestations:

No archeological remains were recorded as a result of fieldwork for the project.

RECOMMENDATIONS

Due to the absence of cultural resources in the project area, Pecos Archeological Consultants are recommending clearance for this project, as planned. This recommendation is based on a surface inspection of the proposed impact zone; should additional, subsurface remains be present in the project areas, they would not be detected without extensive test excavation. Of course, final clearance for this project must be granted by the appropriate government agency.

Page intentionally left blank.

APPENDIX F

List of Geophysical Logs Run

Page intentionally left blank.

Geophysical logs for the drillholes on the H-19 hydropad were run by the U.S. Geological Survey, Water Resources Division, Albuquerque, New Mexico. In this appendix, the logs are incorporated by reference. The geophysical logs are stored in the Sandia National Laboratories WIPP Central Files under WPO#40460.

NOTE: All depths measured in ft below ground level.

Drillhole H-19b0

Type of Log	Date	Depth Driller (ft)	Bottom of Logged Interval (ft)	Logged Interval (ft)
Natural Gamma	04-09-1995	735.5	736	32-736
Natural Gamma (Deepened)	04-23-1995	778.7	779	660-779
Gamma-Gamma (Deepened)	04-23-1995	778.7	779	660-779
Neutron	04-09-1995	735.5	736	32-736
Neutron (Deepened)	04-23-1995	778.7	779	660-779
Caliper	04-09-1995	735.5	736	20-736
Caliper (Deepened)	04-09-1995	778.7	736	670-779

Drillhole H-19b1

Type of Log	Date	Depth Driller (ft)	Bottom of Logged Interval (ft)	Logged Interval (ft)
Natural Gamma	03-07-1995	732.6	731.6	10-731.6
Gamma-Gamma	03-07-1995	732.6	731.6	10-731.6
Neutron	03-07-1995	732.6	731.6	10-731.6

Drillhole H-19b2

Type of Log	Date	Depth Driller (ft)	Bottom of Logged Interval (ft)	Logged Interval (ft)
Natural Gamma	09-06-1995	785.4	778.0	10-778.0
Neutron	09-06-1995	785.4	778.0	10-778.0
Caliper	09-06-1995	785.4	778.0	600-778.0

Drillhole H-19b3

Type of Log	Date	Depth Driller (ft)	Bottom of Logged Interval (ft)	Logged Interval (ft)
Natural Gamma	09-05-1995	784.9	783.0	10-783.0
Neutron	09-05-1995	784.9	783.0	10-783.0
Caliper	09-05-1995	784.9	783.0	600-783.0

Drillhole H-19b4

Type of Log	Date	Depth Driller (ft)	Bottom of Logged Interval (ft)	Logged Interval (ft)
Natural Gamma	09-06-1995	781.5	776.0	10-776.0
Neutron	09-06-1995	781.5	776.0	10-776.0
Caliper	09-06-1995	781.5	776.0	600-776.0

Drillhole H-19b5

Type of Log	Date	Depth Driller (ft)	Bottom of Logged Interval (ft)	Logged Interval (ft)
Natural Gamma	09-06-1995	785.5	785.0	10-785.0
Neutron	09-06-1995	785.5	785.0	10-785.0
Caliper	09-06-1995	785.5	785.0	600-785.0

Drillhole H-19b6

Type of Log	Date	Depth Driller (ft)	Bottom of Logged Interval (ft)	Logged Interval (ft)
Natural Gamma	09-05-1995	788.1	786.0	10-786.0
Neutron	09-05-1995	788.1	786.0	10-786.0
Caliper	09-05-1995	788.1	786.0	600-786.0

Drillhole H-19b7

Type of Log	Date	Depth Driller (ft)	Bottom of Logged Interval (ft)	Logged Interval (ft)
Natural Gamma	09-06-1995	785.0	776.0	10-776.0
Neutron	09-06-1995	785.0	776.0	10-776.0
Caliper	09-06-1995	785.0	776.0	600-776.0

WIPP
UC721 - DISTRIBUTION LIST
SAND98-0071

Federal Agencies

US Department of Energy (4)
Office of Civilian Radioactive Waste Mgmt.
Attn: Deputy Director, RW-2
Acting Director, RW-10
Office of Human Resources & Admin.
Director, RW-30
Office of Program Mgmt. & Integ.
Director, RW-40
Office of Waste Accept., Stor., & Tran.
Forrestal Building
Washington, DC 20585

Yucca Mountain Site Characterization Office
Director, RW-3
Office of Quality Assurance
Attn: Project Director
P. O. Box 30307
North Las Vegas, NV 89036-0307

Yucca Mountain Site Characterization Office
Attn: L. E. Shephard
P.O. Box 30307
MS 523
North Las Vegas, NV 89036-0307

US Department of Energy
Research & Waste Management Division
Attn: Director
P.O. Box E
Oak Ridge, TN 37831

US Department of Energy (5)
Carlsbad Area Office
Attn: G. T. Basabilvazo
D. Galbraith
M. McFadden
R. Lark
J. A. Mewhinney
P.O. Box 3090
Carlsbad, NM 88221-3090

US Department of Energy
Office of Environmental Restoration and
Waste Management
Attn: M. Frei, EM-30
Forrestal Building
Washington, DC 20585-0002

US Department of Energy (3)
Office of Environmental Restoration and
Waste Management
Attn: J. Juri, EM-34, Trevion II
Washington, DC 20585-0002

US Department of Energy
Office of Environmental Restoration and
Waste Management
Attn: S. Schneider, EM-342, Trevion II
Washington, DC 20585-0002

US Department of Energy (2)
Office of Environment, Safety & Health
Attn: C. Borgstrom, EH-25
R. Pelletier, EH-231
Washington, DC 20585

US Department of Energy (2)
Idaho Operations Office
Fuel Processing & Waste Mgmt. Division
785 DOE Place
Idaho Falls, ID 83402

US Environmental Protection Agency (2)
Radiation Protection Programs
Attn: M. Oge
ANR-460
Washington, DC 20460

Boards

Defense Nuclear Facilities Safety Board
Attn: D. Winters
625 Indiana Ave. NW, Suite 700
Washington, DC 20004

Nuclear Waste Technical Review Board (2)
Attn: Chairman
J. L. Cohon
2300 Clarendon Blvd. Ste 1300
Arlington, VA 22201-3367

State Agencies

Attorney General of New Mexico
P.O. Drawer 1508
Santa Fe, NM 87504-1508

Environmental Evaluation Group (3)
Attn: Library
7007 Wyoming NE
Suite F-2
Albuquerque, NM 87109

NM Environment Department (3)
Secretary of the Environment
1190 St. Francis Drive
Santa Fe, NM 87503-0968

NM Bureau of Mines & Mineral Resources
Socorro, NM 87801

Laboratories/Corporations

Battelle Pacific Northwest Laboratories
Battelle Blvd.
Richland, WA 99352

Los Alamos National Laboratory
Attn: B. Erdal, INC-12
P.O. Box 1663
Los Alamos, NM 87544

Tech Reps, Inc. (3)
Attn: J. Chapman (1)
Loretta Robledo (2)
5000 Marble NE, Suite 222
Albuquerque, NM 87110

Westinghouse Electric Corporation (5)
Attn: Library
J. Epstein
J. Lee
R. Kehrman
R. G. Richardson

P.O. Box 2078
Carlsbad, NM 88221

S. Cohen & Associates
Attn: Bill Thurber
1355 Beverly Road
McLean, VA 22101

Duke Engineering & Services, Inc. (3)
Attn: T.L. Jones
Library
9111 Research Blvd.
Austin, TX 78758

Duke Engineering & Services, Inc.
Attn: W. A. Stensrud
1012 W. Pierce Suite A
Carlsbad, NM 88220

Duke Engineering & Services, Inc. (3)
Attn: D. A. Chace
Library
1650 University Blvd. NE Suite 300
Albuquerque, NM 87102-1732

National Academy of Sciences WIPP Panel

Tom Kiess (15)
Staff Study Director
GF456
2101 Constitution Ave.
Washington, DC 20418

Universities

University of New Mexico
Geology Department
Attn: Library
141 Northrop Hall
Albuquerque, NM 87131

University of Washington
College of Ocean & Fishery Sciences
Attn: G. R. Heath
583 Henderson Hall, HN-15
Seattle, WA 98195

Libraries

Thomas Brannigan Library
Attn: D. Dresp
106 W. Hadley St.
Las Cruces, NM 88001

Government Publications Department
Zimmerman Library
University of New Mexico
Albuquerque, NM 87131

New Mexico Junior College
Pannell Library
Attn: R. Hill
Lovington Highway
Hobbs, NM 88240

New Mexico State Library
Attn: N. McCallan
325 Don Gaspar
Santa Fe, NM 87503

New Mexico Tech
Martin Speere Memorial Library
Campus Street
Socorro, NM 87810

WIPP Public Reading Room
Carlsbad Public Library
101 S. Halagueno St.
Carlsbad, NM 88220

Foreign Addresses

Atomic Energy of Canada, Ltd.
Whiteshell Laboratories
Attn: B. Goodwin
Pinawa, Manitoba, CANADA R0E 1L0

Francois Chenevier (2)
ANDRA
Parc de la Croix Blanche
1-7 rue Jean Monnet
92298 Chatenay-Malabry Cedex
FRANCE

Claude Sombret
Centre d'Etudes Nucleaires de la Vallee Rhone
CEN/VALRHO
S.D.H.A. B.P. 171
30205 Bagnols-Sur-Ceze
FRANCE

Commissariat a L'Energie Atomique
Attn: D. Alexandre
Centre d'Etudes de Cadarache
13108 Saint Paul Lez Durance Cedex
FRANCE

Bundesanstalt fur Geowissenschaften und
Rohstoffe
Attn: M. Langer
Postfach 510 153
D-30631 Hannover
GERMANY

Bundesministerium fur Forschung und
Technologie
Postfach 200 706
5300 Bonn 2
GERMANY

Institut fur Tieflagerung
Attn: K. Kuhn
Theodor-Heuss-Strasse 4
D-3300 Braunschweig
GERMANY

Gesellschaft fur Anlagen und Reaktorsicherheit
(GRS)
Attn: B. Baltes
Schwertnergasse 1
D-50667 Cologne
GERMANY

Shingo Tashiro
Japan Atomic Energy Research Institute
Tokai-Mura, Ibaraki-Ken, 319-11
JAPAN

Netherlands Energy Research Foundation ECN
Attn: J. Prij
3 Westerduinweg
P.O. Box 1
1755 ZG Petten
THE NETHERLANDS

Svensk Karnbransleforsorjning AB
Attn: F. Karlsson
Project KBS (Karnbranslesakerhet)
Box 5864
S-102 48 Stockholm
SWEDEN

Nationale Genossenschaft fur die Lagerung
Radioaktiver Abfalle (2)
Attn: S. Vomvoris
P. Zuidema
Hardstrasse 73
CH-5430 Wettingen
SWITZERLAND

AEA Technology
Attn: J. H. Rees
D5W/29 Culham Laboratory
Abington, Oxfordshire OX14 3DB
UNITED KINGDOM

AEA Technology
Attn: W. R. Rodwell
044/A31 Winfrith Technical Centre
Dorchester, Dorset DT2 8DH
UNITED KINGDOM

AEA Technology
Attn: J. E. Tinson
B4244 Harwell Laboratory
Didcot, Oxfordshire OX11 0RA
UNITED KINGDOM

Others

D. W. Powers
HC 12
Box 87
Anthony, TX 79821

Internal

<u>MS</u>	<u>Org.</u>	
0735	6115	P. B. Davies
0735	6115	A. R. Lappin
0735	6115	R. L. Beauheim
0735	6115	L. C. Meigs
0735	6115	S. A. McKenna
0735	6115	S. J. Altman
0735	6115	P. C. Reeves
0735	6115	C. S. Chocas
0735	6115	R. M. Holt (2)
0737	6831	E. J. Nowak
0737	6833	J. R. Tillerson
0779	6849	D. R. Anderson
0779	6848	H. N. Jow
0771	6800	M. Chu
0733	6832	J. T. Holmes
1395	6821	M. Marietta
1156	9322	J. W. Mercer (2)
1156	9322	D. L. Cole (2)
0731	6811	K. Hart (2)
0731	4415	NWM Library (20)
9018	8940-2	Central Technical Files
0899	4916	Technical Library (2)
0619	12690	Review and Approval Desk, For DOE/OSTI (2)